

UFS







Underfloor systems

THINK CONNECTED.



GES service outlets

	GES4-2 service outlets for dry-cleaned floors	Service units Mounting support Inspection cover	4 4 4
	GES6-2 service outlets for dry-cleaned floors	Service units Mounting support Inspection cover	5 5 5
	Installation units	Adapter plate	6
	Fastening brackets for service outlets	Universal fastening brackets Fastening brackets for screed thicknesses	7 7

GES4-2 service outlets for dry-cleaned floors

GES4 universal service outlet

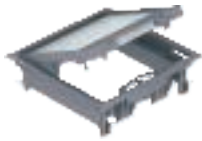

Type	Colour	Flooring depth	Pack.	Weight	Item No.
		mm	pcs	kg/100 pcs.	
GES4-2 U 7011 UK	Iron grey	10	1	124,000	7405 19 9

PA Polyamide

/pc.

Service outlet for installation frame MT 4R4 AP2 in metal for mounting of cover plates of the design APMT2. Service outlet for the use in underfloor sockets UDS and system floors. Universal fastening brackets adjustable to raised floor thicknesses up to 75 mm. Carpet protection frame, hinged cover and cord outlet made of polyamide. 5 mm floor covering recess in the hinged lid, if necessary, adjustable to 3, 8 or 10 mm.

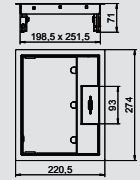

GES4M10 universal service outlet



Type	Material symbol	Flooring depth	Pack.	Weight	Item No.
		mm	pcs	kg/100 pcs.	
GES4M 10DB UK	V2A	10	1	180,000	7405 19 3

V2A Stainless steel, grade 304

/pc.

Service outlet for installation frame MT 4R4 AP2 in stainless steel for mounting of 2 cover plates of the design APMT2. Service outlet for the use in underfloor sockets UDS and system floors. Universalbefestigungswinkel einstellbar auf Doppelbodenstärken bis 65 mm. Carpet protection frame, hinged cover and cord outlet made of polyamide. 5 mm floor covering recess in the hinged lid, if necessary, adjustable to 3, 8 or 10 mm. Up to 6 individual Modul 45® devices can be installed.

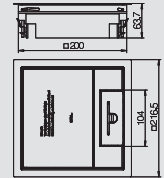

Mounting support, nominal size 4 and R4, for APMT2 cover plates



Type	Pack.	Weight	Item No.
	pcs	kg/100 pcs.	
MT 4R4 AP 2 UK	1	12,310	7407 75 3

St Steel

FS Strip-galvanised

/pc.

Mounting support for accepting APMT2 cover plates, which aid the installation of accessories in installation units of nominal sizes 4 and R4.

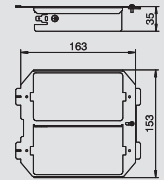

ZES4 inspection cover, universal

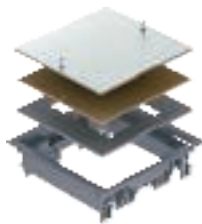

Type	Colour	Flooring depth	Pack.	Weight	Item No.
		mm	pcs	kg/100 pcs.	
ZES4-2U10 7011UK	Iron grey	10	1	158,000	7406 69 9

PA Polyamide

/pc.

Junction box insert for blank closing of a square mounting opening of nominal size 4 in an underfloor duct or trunking system or in raised floor. Polyamide floor covering profile. Recess is 5 mm when delivered, if necessary, adjustable to 3, 8 or 10 mm.

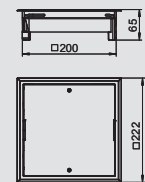

GES6-2 service outlets for dry-cleaned floors

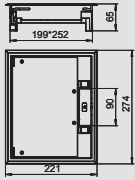

GES6 universal service outlet

Type	Colour	Flooring depth	Pack.	Weight	Item No.
		mm	pcs	kg/100 pcs.	
GES6-2 U 7011 UK	Iron grey	10	1	138,000	7405 32 5

PA Polyamide /pc.

Service outlet for installation frame MT 6 AP2 in metal for mounting of 3 cover plates of the design APMT2. Service outlet for the use in underfloor sockets UDS and system floors. Universal fastening brackets adjustable to raised floor thicknesses up to 65 mm. Carpet protection frame, hinged cover and cord outlet made of polyamide. 5 mm floor covering recess in the hinged lid, if necessary, adjustable to 3, 8 or 10 mm.

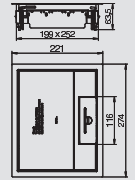

GES6M10 universal service outlet

Type	Material symbol	Flooring depth	Pack.	Weight	Item No.
		mm	pcs	kg/100 pcs.	
GES6M 10DB UK	V2A	10	1	220,000	7405 30 5

V2A Stainless steel, grade 304 /pc.

Service outlet in stainless steel for installation frame MT6 AP2 in metal for mounting of 3 cover plates of the design APMT2. Service outlet for the use in underfloor sockets UDS and system floors. Universal fastening brackets adjustable to raised floor thicknesses up to 65 mm. Carpet protection frame, hinged cover and cord outlet made of polyamide. 5 mm floor covering recess in the hinged lid, if necessary, adjustable to 3, 8 or 10 mm.

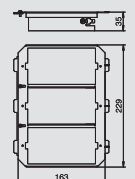

Mounting support, nominal size 6 for cover plate APMT2

Type	Pack.	Weight	Item No.
	pcs	kg/100 pcs.	
MT 6 AP2 UK	1	20,000	7407 75 4

St Steel **FS** Strip-galvanised /pc.

Mounting support for accepting APMT2 cover plates, which aid the installation of accessories in installation units of nominal size 6.

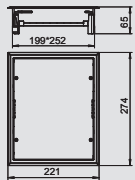

ZES6 inspection cover, universal

Type	Colour	Flooring depth	Pack.	Weight	Item No.
		mm	pcs	kg/100 pcs.	
ZES6-2U10 7011UK	Iron grey	10	1	150,000	7406 73 9

PA Polyamide /pc.

Junction box insert for blank closing of a square mounting opening of nominal size 6 in an underfloor duct or trunking system or in raised floor. Polyamide floor covering profile. Recess is 5 mm when delivered, if necessary, adjustable to 3, 8 or 10 mm.

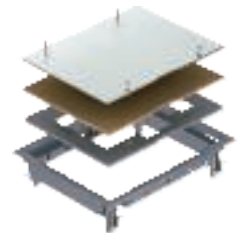

Installation device AP MT2



Cover plate APMT2/0

Type	Length	Pack.	Weight	Item No.
	mm	pcs	kg/100 pcs.	
AP MT2 0 UK	163	20	12,300	7406 93 0

St Steel **FSO** Strip galvanised/organically coated /pc.
For blanking locking on an unused compartment in an MT AP2 mounting support.

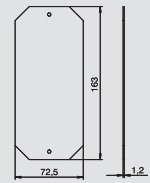

Cover plate APMT2/1

Type	Length	Pack.	Weight	Item No.
	mm	pcs	kg/100 pcs.	
AP MT2 1 UK	163	20	11,100	7406 93 1

St Steel **FSO** Strip galvanised/organically coated /pc.
Cover plate for mounting support MT AP2 for the installation of 4 data connection sockets of the design LJU6C.

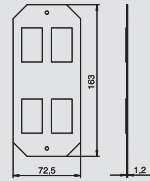

Cover plate APMT2 with single socket

Type	Colour	Length	Pack.	Weight	Item No.
		mm	pcs	kg/100 pcs.	
AP MT2 BS SSO	Grey-white	163	4	17,700	7407 87 6

St Steel **FSO** Strip galvanised/organically coated /pc.
Cover plate with a switched single socket for installation in mounting supports beneath GES installation units and cassettes. Socket with increased contact protection with screw connection, 3-pole, 13 A, 250 V~, corresponds to BS 1363.

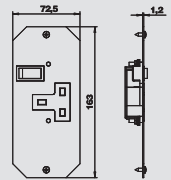

Cover plate APMT2 with two single sockets

Type	Colour	Length	Pack.	Weight	Item No.
		mm	pcs	kg/100 pcs.	
AP MT2 BS 2xSSO	Grey-white	163	4	23,700	7407 87 9

St Steel **FSO** Strip galvanised/organically coated /pc.
Cover plate with two switched single sockets for installation in mounting supports beneath GES installation units and cassettes. Sockets with increased contact protection with screw connection, 3-pole, 13 A, 250 V~, corresponds to BS 1363.

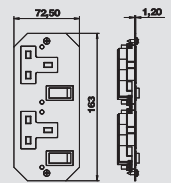

Cover plate APMT2 with double socket

Type	Colour	Length	Pack.	Weight	Item No.
		mm	pcs	kg/100 pcs.	
AP MT2 BS 2SSO	Grey-white	163	4	21,500	7407 87 2

St Steel **FSO** Strip galvanised/organically coated /pc.
Cover plate with a switched double socket for installation in mounting supports beneath GES installation units and cassettes. Socket with increased contact protection with screw connection, 3-pole, 13 A, 250 V~, corresponds to BS 1363.

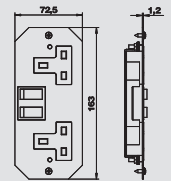

Fastening bracket for service outlet

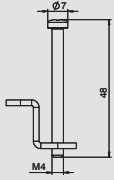

Universal fastening bracket type 2 for 4 fastening points

Type	Pack.	Weight		Item No.
		PU	kg/100 PUs	
GESUB2 4	1		0,432	7407 55 9

St Steel

/VPE

Four universal fastenings with folding clamping bracket for service outlets and junction box inserts of the -2 generation with four or eight system fastenings. Spare part.

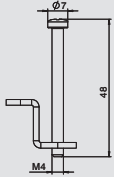

Universal fastening bracket type 2 for 6 fastening points

Type	Pack.	Weight		Item No.
		PU	kg/100 PUs	
GESUB2 6	1		0,648	7407 56 1

St Steel

/VPE

Six universal fastenings with folding clamping bracket for service outlets and junction box inserts of the -2 generation with six system fastenings. Spare part.



Fastening bracket for screed height more than 100 mm

Type	Pack.	Weight		Item No.
		PU	kg/100 PUs	
GES4 BG UDS	1		10,000	7407 54 9

Al Aluminium



/VPE

Fastening bracket for service outlets and junction box inserts in screed-covered duct systems with underfloor boxes of type UDS for screed heights of more than 100 mm.

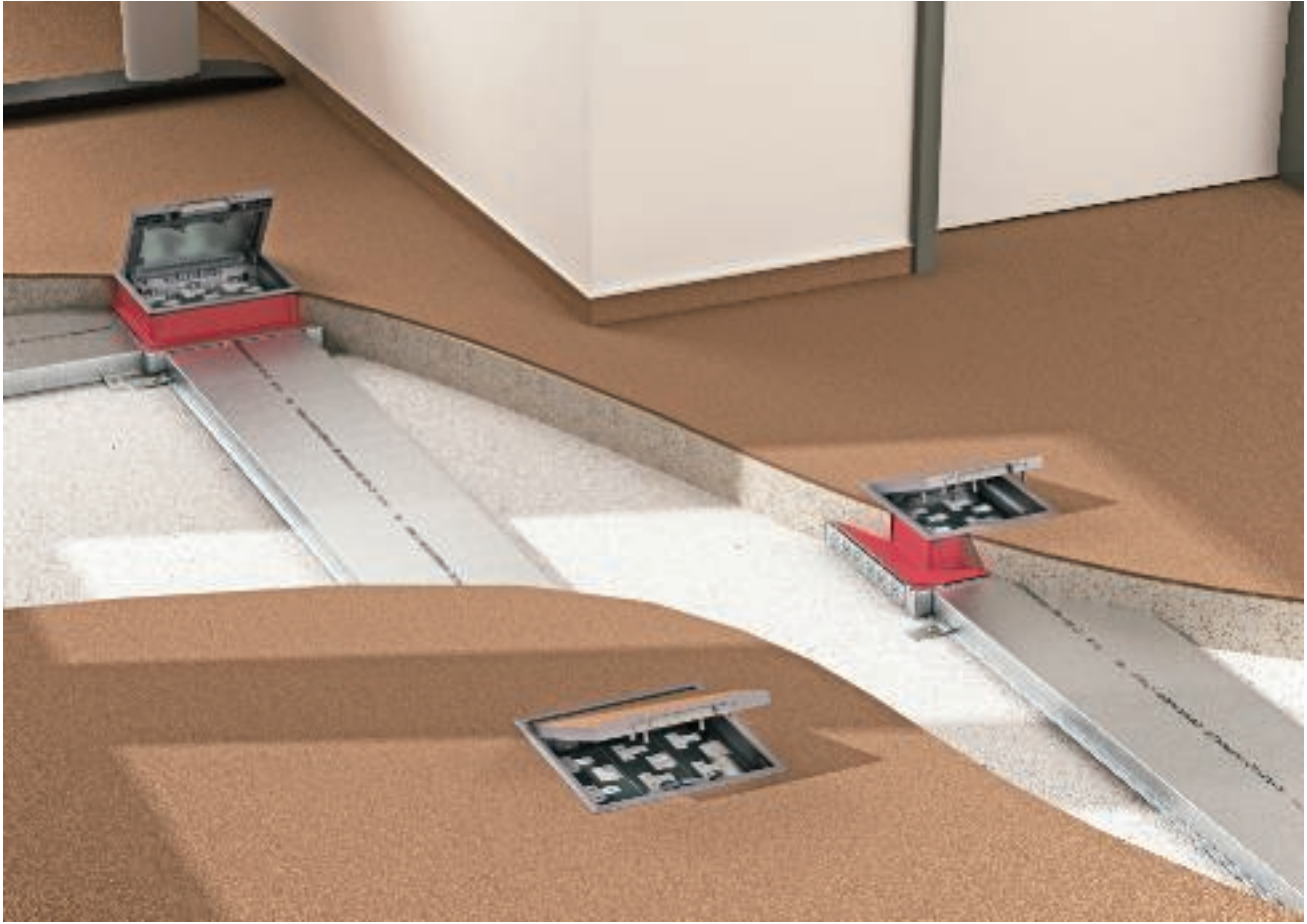



EUK-SN screed-covered duct system, self-levelling

	UDS Underfloor socket, self-levelling	Underfloor socket UDS Screed protection cover elevation Separating element and protection connection bracket	10 10 10
	Metallic duct system, duct height 38 mm	Underfloor installation duct Connection shackle Vertical bend	11 11 11
	Duct accessories	Bolt tie Anchors Flattener	12 12 12

Underfloor outlet box, self-levelling



Underfloor box UDS for installation pipe and metal duct

Type	Screed height	Pack.	Weight	Item No.
	mm	pcs	kg/100 pcs.	
UDSSD 25038 4 UK	65-90	1	248,000	7400 36 5

St Steel /pc.

Underfloor connection socket with fixed, unchangeable 201 x 201 mm installation opening for an installation unit of nominal size 4. The mounting opening is created using the lined body contained in the scope of supply. The underfloor socket possesses installation openings for 3-compartment sheet steel underfloor ducts of the nominal size 25038 as well as six installation pipes M20 or M25 on all four sides. The socket is principally suited for use in floor structures in cement screed with a structure height of up to 90 mm.

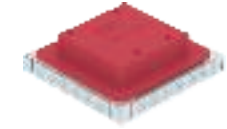
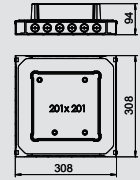

Underfloor box UDS for installation pipe and metal duct

Type	Pack.	Weight	Item No.
	pcs	kg/100 pcs.	
SKE 201x201 UK	1	15,000	7404 39 5

PS Polystyrene /pc.

Screed protection cover elevation for heightening the UDS for installation openings of nominal size 4. Elevation by 40 mm.

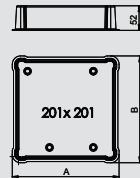

Underfloor box UDS for installation pipe and metal duct

Type	Screed height	Pack.	Weight	Item No.
	mm	pcs	kg/100 pcs.	
UDSSD 25038 6 UK	65-90	1	230,000	7400 36 6

St Steel **FS** Strip-galvanised /pc.

Underfloor outlet box with fixed, unchangeable 202 x 254 mm installation opening for an installation unit of nominal size 6. The mounting opening is created using the screed protection cover contained in the scope of supply. The underfloor socket possesses installation openings for 3-compartment sheet steel underfloor ducts of the nominal size 25038 as well as six installation pipes M20 or M25 on all four sides. The socket is principally suited for use in floor structures in cement screed with a structure height of up to 90 mm.

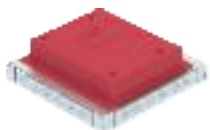
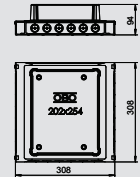

Underfloor box UDS for installation pipe and metal duct

Type	Pack.	Weight	Item No.
	pcs	kg/100 pcs.	
SKE 202x245 UK	1	17,000	7404 39 7

PS Polystyrene /pc.

Screed protection cover elevation for heightening the UDS for installation openings of nominal size 6. Elevation by 40 mm.

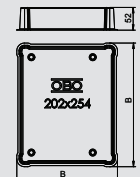

Separating retainer, intersection, for UDS

Type	Pack.	Weight	Item No.
	pcs	kg/100 pcs.	
UDS 9 C3	1	58,000	7428 33 6

St Steel **FS** Strip-galvanised /pc.

Separating retainer, 3-compartment, for intersection in a UDS underfloor box.



Earth conductor clamp

Type	Pack.	Weight	Item No.
	pcs	kg/100 pcs.	
8AWR	10	0,641	6288 70 4

St Steel **G** Electrogalvanised /pc.

Protective conductor connection bracket to include steel and aluminium device installation trunking as well as service poles in the protective measures. Clamping area : 2 x 1.5 - 4 mm²

If there is a fault, metallic parts will carry voltage. Tighten the contact screw with at least 1.2 Nm or ensure the contact with mechanical work.

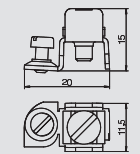

Metallic duct system, duct height 38 mm

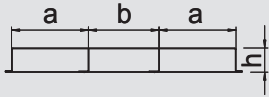

EÜK metal underfloor installation duct, cover height 38 mm



Type	Dimension a	Dimension h	Width	Duct height	Length	Number of compartments	Pack.	Weight	Item No.
	mm	mm	mm	mm	mm	pc.	m	kg/100 m	
S3 25038 UK	90	38	250	38	2000	3	2	466,000	7400 32 9

St Steel **FS** Strip-galvanised /m
Underfloor installation duct for routing cables under the screed.

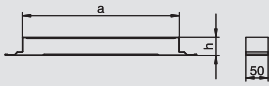

EÜK connection shackle



Type	Dimension a	Duct height	Pack.	Weight	Item No.
	mm	mm	pcs	kg/100 pcs.	
VL 25038E UK	250	38	1	28,500	7400 96 9

St Steel **FS** Strip-galvanised /pc.
Duct connector for mounting screed-covered underfloor installation ducts.

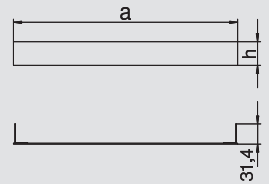

EÜK duct end closure section



Type	Dimension a	Dimension h	Pack.	Weight	Item No.
	mm	mm	pcs	kg/100 pcs.	
SES 25037 UK	250	37	1	3,700	7400 00 7

St Steel **FS** Strip-galvanised /pc.
End closure for screed-covered underfloor installation ducts.

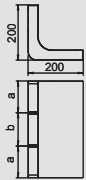

EÜK vertical bend



Type	Dimension a	Dimension b	Width	Duct height	Number of compartments	Pack.	Weight	Item No.
	mm	mm	mm	mm	pc.	pcs	kg/100 pcs.	
KV3 25038 UK	90	70	250	38	3	1	226,300	7400 64 9

St Steel **FS** Strip-galvanised /pc.
For vertical direction changes of screed-covered underfloor installation ducts (wall connections, supplies).

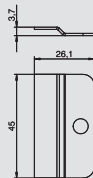
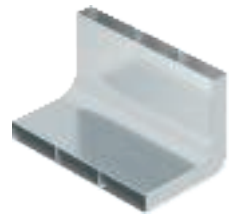

EÜK fastening strap



Type	Pack.	Weight	Item No.
	pcs	kg/100 pcs.	
BL1 UK	20	0,800	7428 50 1

St Steel **FS** Strip-galvanised /pc.
Fixing bracket for underfloor screed-covered ducts.



Duct accessories



Bolt tie

Type	Dimension	Anchor length	Bore hole Ø	Pack.	Weight	Item No.
	mm	mm	mm	pcs	kg/100 pcs.	
MMS6X50	6 x 50	50	5	100	0,960	3498 10 7



St Steel **G** Electrogalvanised /100 pc.

Fire protection bolt tie with pan head for direct mounting without additional anchors. Drive T30, drill hole 5 mm. Fire protection tested according to DIN 4102 for concrete and masonry.

Substrate

The bolt ties are suitable for screwing into the following types of masonry:

- Calcareous sandstone - Full brick (KSV)
- Calcareous sandstone - Hollow brick (KSL)
- Whole brick (Vz)

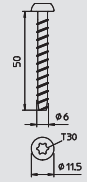

OBO anchors

Type	Shank length	Flange-Ø	Shipping box	Pack.	Weight	Item No.
	mm	mm	pcs	pcs	kg/100 pcs.	
903 RB 15	15	10	6000	200	0,295	3105 01 6
903 RB 18	18	10	4000	200	0,348	3105 02 4
903 RB 22	22	10	4000	200	0,325	3105 03 2



St Steel /100 pc.

Hardened steel, shiny without thread.

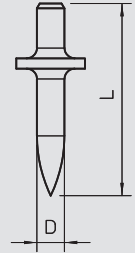

Flattener with hand protection

Type	Shipping box	Pack.	Weight	Item No.
	pcs	pcs	kg/100 pcs.	
915 RBS M4	12	1	50,000	3031 50 0



St Steel /pc.

Flattener with hand protection for OBO anchors 903/RB Ø 4 mm and also for OBO anchors 904 with M4 thread.

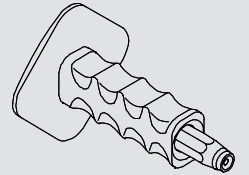

OBO knock-in anchors

Type	Dowel Ø	Length	Pull-out force	Shipping box	Pack.	Weight	Item No.
	mm	mm	N min/concrete	pcs	pcs	kg/100 pcs.	
910 SD 6X35	6	35	260	1200	100	0,310	2351 05 6
910 SD 6X40	6	40	260	1000	100	0,555	2351 06 4



PA Polyamide /100 pc.

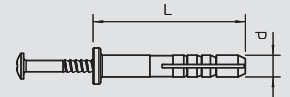

Knock-in anchor: steel, electrogalvanised and transparently passivated.







GRAF9 service outlets

	Service outlet for wet-care floors	GRAF9 service outlet Mounting support Seals and care agents	16 16 16
	Installation units	Cover plates AP MT5	17

Service outlet for wet-care floors



GRAF9 service outlet, wet-care with structured lid

Type	Colour	Pack.	Weight	Item No.
		pcs	kg/100 pcs.	
GRAF9-2 U 9011UK	Graphite black	1	246,000	7405 75 1

AIG Cast aluminium /pc.

Round service outlet with floor covering protection frame for the installation of accessories for universal use in duct systems, raised and cavity floors with wet-cleaned floor covering. Hinged lid with concentric rings. Surface: bare metal with a finely scored structure, recesses varnished. Floor covering protection frame and hinged lid made of die-cast aluminium, tube body made of die-cast zinc.

The minimum installation depth is 75 mm when using MT 9R9 AP5 mounting supports.

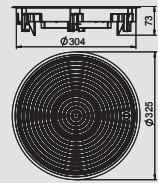

GRAF9-2 service outlet, wet-care, with floor covering recess

Type	Colour	Pack.	Weight	Item No.
		pcs	kg/100 pcs.	
GRAF9-2 BA4 UK	–	1	258,000	7405 81 3

AIG Cast aluminium Bright /pc.

Round service outlet with floor covering protection frame for the installation of accessories for universal use in duct systems, raised and cavity floors with wet-cleaned floor covering. Hinged lid and tube body with 4 mm floor covering recess. Floor covering protection frame and hinged lid made of die-cast aluminium, tube body made of die-cast zinc.

The minimum installation depth is 75 mm when using MT 9R9 AP5 mounting supports.

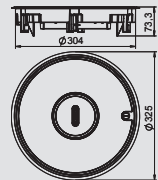

Mounting support, nominal size 9 and R9, for APMT5 cover plates

Type	Pack.	Weight	Item No.
	pcs	kg/100 pcs.	
MT 9R9 AP 5 UK	1	25,650	7407 75 5

St Steel **FS** Strip-galvanised /pc.

Mounting support for accepting APMT5 cover plates, which aid the installation of accessories in installation units of nominal sizes 9 and R9.

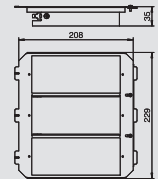

Round seal for tube body

Type	Pack.	Weight	Item No.
	pcs	kg/100 pcs.	
RD2 TUK2	1	0,200	7407 09 8

Ethylene propylene diene rubber DIN 1629 /pc.

Round seal for tube body TUK2 - spare part.

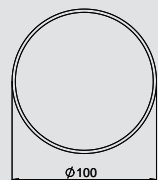

Round seals for GRAF9-2 and tube body

Type	Pack.	Weight	Item No.
	pcs	kg/100 pcs.	
RD GRAF9-2	1	1,650	7407 09 9

Ethylene propylene diene rubber DIN 1629 /pc.

Round seals for GRAF9-2 and tube body - spare part.

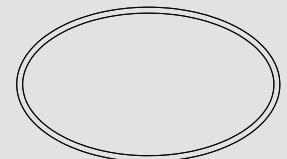

Care agent for tube body seal

Type	Pack.	Weight	Item No.
	pcs	kg/100 pcs.	
PF-G	1	0,800	7407 11 0

Synthetic oil-based montage paste /pc.

Cleaning agent for round seals RD2, flat seals FD2 QNK and tube body seal RD2TUK2.

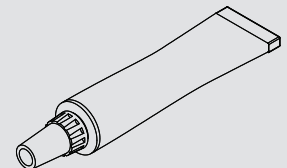

Installation device AP MT5

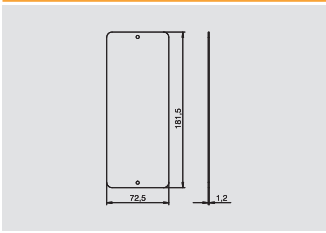

Cover plate APMT5/0

Type	Length	Pack.	Weight	Item No.
	mm	pcs	kg/100 pcs.	
AP MT5 0 UK	181.5	20	12,700	7406 90 3

St Steel **FSO** Strip galvanised/organically coated /pc.
For blanking locking on an unused compartment in an MT AP2 mounting support.

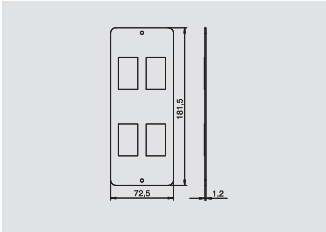

Cover plate APMT5/1

Type	Length	Pack.	Weight	Item No.
	mm	pcs	kg/100 pcs.	
AP MT5 1 UK	181.5	40	12,700	7406 88 4

St Steel **FSO** Strip galvanised/organically coated /pc.
Cover plate for mounting support MT AP5 for the installation of 4 data connection sockets of the design LJU6C.

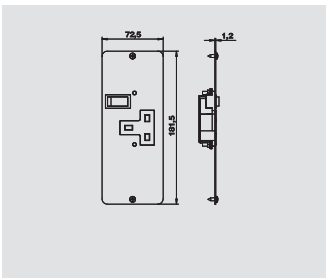

Cover plate APMT5 with single socket

Type	Colour	Length	Pack.	Weight	Item No.
		mm	pcs	kg/100 pcs.	
AP MT5 BS SSO	Grey-white	181.5	4	18,700	7407 87 4

St Steel **FSO** Strip galvanised/organically coated /pc.
Cover plate with a switched single socket for installation in mounting supports beneath GES installation units and cassettes. Socket with increased contact protection with screw connection, 3-pole, 13 A, 250 V~, corresponds to BS 1363.

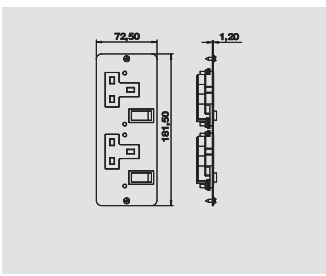

Cover plate APMT5 with two single sockets

Type	Colour	Length	Pack.	Weight	Item No.
		mm	pcs	kg/100 pcs.	
AP MT5 BS 2xSSO	Grey-white	181.5	4	25,300	7407 87 8

St Steel **FSO** Strip galvanised/organically coated /pc.
Cover plate with two switched single sockets for installation in mounting supports beneath GES installation units and cassettes. Sockets with increased contact protection with screw connection, 3-pole, 13 A, 250 V~, corresponds to BS 1363.

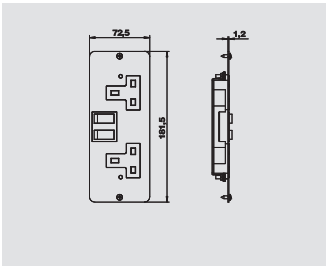

Cover plate APMT5 with double socket



Type	Colour	Length	Pack.	Weight	Item No.
		mm	pcs	kg/100 pcs.	
AP MT5 BS 2SSO	Grey-white	181.5	4	23,200	7407 87 0

St Steel **FSO** Strip galvanised/organically coated /pc.
Cover plate with a switched double socket MK14374D1WHI for installation in mounting supports beneath GES installation units and cassettes. Socket with increased contact protection with screw connection, 3-pole, 13 A, 250 V~, corresponds to BS 1363.





Screed-covered duct system, EUK

	UZD350 Underfloor boxes	UZD350-3 underfloor box Mounting lid Heavy-duty support	20 20 20
	Metallic duct system, duct height 38 mm	Underfloor installation duct Connection shackle Vertical bend	21 21 21
	Duct accessories	Bolt tie Anchors Flattener	22 22 22

EÜK | Underfloor box UZD350-3



UZD350-3 for screed height 70–125 mm

Type	Dimension A	Dimension a	Dimension b	Screed height	Pack.	Weight	Item No.
	mm	mm	mm	mm	pcs	kg/100 pcs.	
UZD 350-3 UK	467	362	383	70-125	1	590,000	7410 04 9

St Steel **FS** Strip-galvanised /pc.

Underfloor junction and branch box for screed-covered underfloor installation systems.

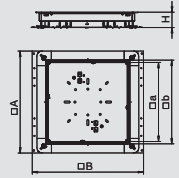
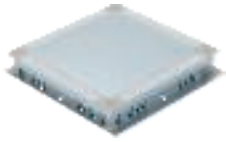

Mounting lid, heavy-duty 350-3R9

Type	Dimension A	Dimension d Ø	Screed height	Pack.	Weight	Item No.
	mm	mm	mm	pcs	kg/100 pcs.	
DUG 350-3SL70 UK	383	305	70-105	1	283,000	7400 48 8
DUG 350-3SL100UK	383	305	100-140	1	280,000	7400 49 2

St Steel **FS** Strip-galvanised /pc.

Heavy-duty mounting lid UZD350-3 for installation in a GRAF9-2 installation unit. With four heavy-duty supports which are connected to the blanking lid and are height-adjustable.

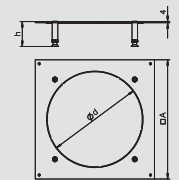

Mounting lid 350-3R9

Type	Dimension A	Dimension d Ø	Pack.	Weight	Item No.
	mm	mm	pcs	kg/100 pcs.	
DUG 350-3 R9 UK	383	305	1	230,000	7400 55 0

St Steel **FS** Strip-galvanised /pc.

Mounting lid for underfloor junction and branch boxes of type UZD350-3 for the installation of an installation unit of nominal size R9

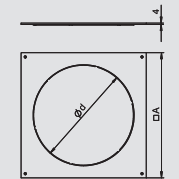

DSSL heavy-duty support

Type	Screed height	Pack.	Weight	Item No.
	mm	pcs	kg/100 pcs.	
DSSL2 70 110 UK	70-110	4	23,000	7410 16 9
DSSL2 100 140 UK	100-140	4	26,000	7410 17 3

St Steel **FS** Strip-galvanised /pc.

Heavy-duty support to support the corner areas of UZD-3 and square frame cassettes. Height adjustment bolt with locknut.

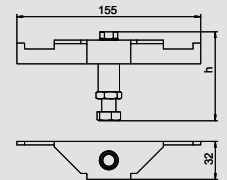

Cover fastening screw

Type	Pack.	Weight	Item No.
	pcs	kg/100 pcs.	
DBS DUG	20	0,150	7400 55 9

St Steel **G** Electrogalvanised /pc.

Lid fastening screws for underfloor sockets UZD-3 and UGD-3.

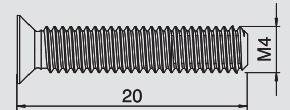

Earth conductor clamp

Type	Pack.	Weight	Item No.
	pcs	kg/100 pcs.	
8AWR	10	0,641	6288 70 4

St Steel **G** Electrogalvanised /pc.

Protective conductor connection bracket to include steel and aluminium device installation trunking as well as service poles in the protective measures.

Clamping area : 2 x 1.5 – 4 mm²

If there is a fault, metallic parts will carry voltage. Tighten the contact screw with at least 1.2 Nm or ensure the contact with mechanical work.

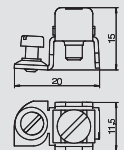

Metallic duct system, duct height 38 mm

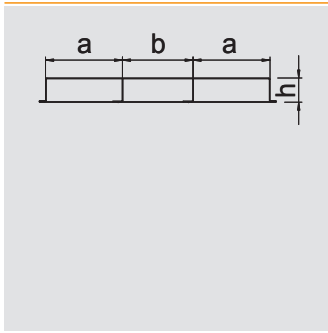

EÜK metal underfloor installation duct, cover height 38 mm



Type	Dimension a	Dimension h	Width	Duct height	Length	Number of compartments	Pack.	Weight	Item No.
	mm	mm	mm	mm	mm	pc.	m	kg/100 m	
S3 25038 UK	90	38	250	38	2000	3	2	466,000	7400 32 9

St Steel **FS** Strip-galvanised /m
Underfloor installation duct for routing cables under the screed.

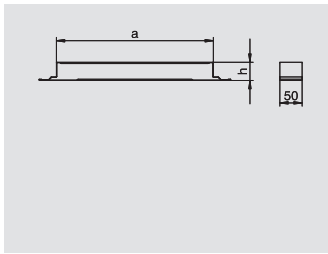
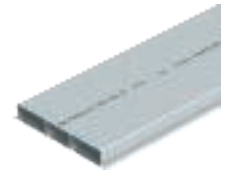

EÜK connection shackle



Type	Dimension a	Duct height	Pack.	Weight	Item No.
	mm	mm	pcs	kg/100 pcs.	
VL 25038E UK	250	38	1	28,500	7400 96 9

St Steel **FS** Strip-galvanised /pc.
Duct connector for mounting screed-covered underfloor installation ducts.

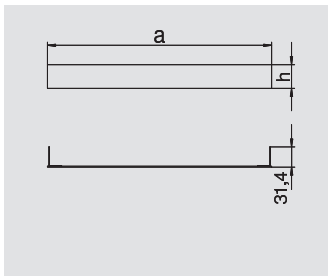

EÜK duct end closure section



Type	Dimension a	Dimension h	Pack.	Weight	Item No.
	mm	mm	pcs	kg/100 pcs.	
SES 25037 UK	250	37	1	3,700	7400 00 7

St Steel **FS** Strip-galvanised /pc.
End closure for screed-covered underfloor installation ducts.

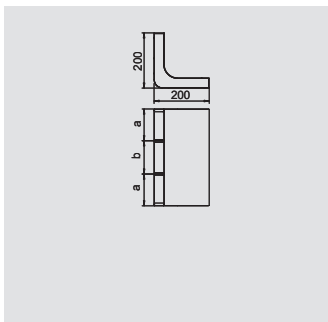

EÜK vertical bend



Type	Dimension a	Dimension b	Width	Duct height	Number of compartments	Pack.	Weight	Item No.
	mm	mm	mm	mm	pc.	pcs	kg/100 pcs.	
KV3 25038 UK	90	70	250	38	3	1	226,300	7400 64 9

St Steel **FS** Strip-galvanised /pc.
For vertical direction changes of screed-covered underfloor installation ducts (wall connections, supplies).

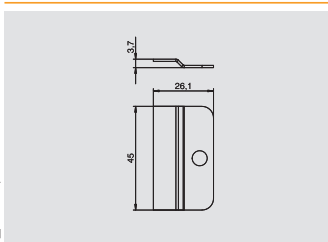
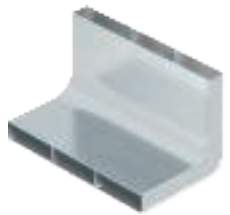

EÜK fastening strap



Type	Pack.	Weight	Item No.
	pcs	kg/100 pcs.	
BL1 UK	20	0,800	7428 50 1

St Steel **FS** Strip-galvanised /pc.
Fixing bracket for underfloor screed-covered ducts.



Duct accessories



Bolt tie

Type	Dimension	Anchor length	Bore hole Ø	Pack.	Weight	Item No.
	mm	mm	mm	pcs	kg/100 pcs.	
MMS6X50	6 x 50	50	5	100	0,960	3498 10 7



St Steel **G** Electrogalvanised /100 pc.

Fire protection bolt tie with pan head for direct mounting without additional anchors. Drive T30, drill hole 5 mm. Fire protection tested according to DIN 4102 for concrete and masonry.

Substrate

The bolt ties are suitable for screwing into the following types of masonry:

- Calcareous sandstone - Full brick (KSV)
- Calcareous sandstone - Hollow brick (KSL)
- Whole brick (Vz)

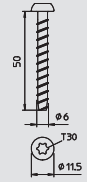

OBO anchors

Type	Shank length	Flange-Ø	Shipping box	Pack.	Weight	Item No.
	mm	mm	pcs	pcs	kg/100 pcs.	
903 RB 15	15	10	6000	200	0,295	3105 01 6
903 RB 18	18	10	4000	200	0,348	3105 02 4
903 RB 22	22	10	4000	200	0,325	3105 03 2



St Steel /100 pc.

Hardened steel, shiny without thread.

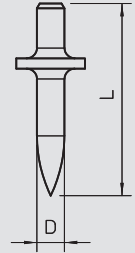

Flattener with hand protection

Type	Shipping box	Pack.	Weight	Item No.
	pcs	pcs	kg/100 pcs.	
915 RBS M4	12	1	50,000	3031 50 0



St Steel /pc.

Flattener with hand protection for OBO anchors 903/RB Ø 4 mm and also for OBO anchors 904 with M4 thread.

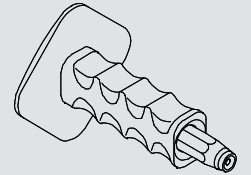

OBO knock-in anchors

Type	Dowel Ø	Length	Pull-out force	Shipping box	Pack.	Weight	Item No.
	mm	mm	N min/concrete	pcs	pcs	kg/100 pcs.	
910 SD 6X35	6	35	260	1200	100	0,310	2351 05 6
910 SD 6X40	6	40	260	1000	100	0,555	2351 06 4



PA Polyamide /100 pc.

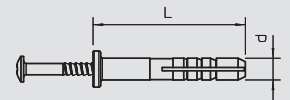

Knock-in anchor: steel, electrogalvanised and transparently passivated.



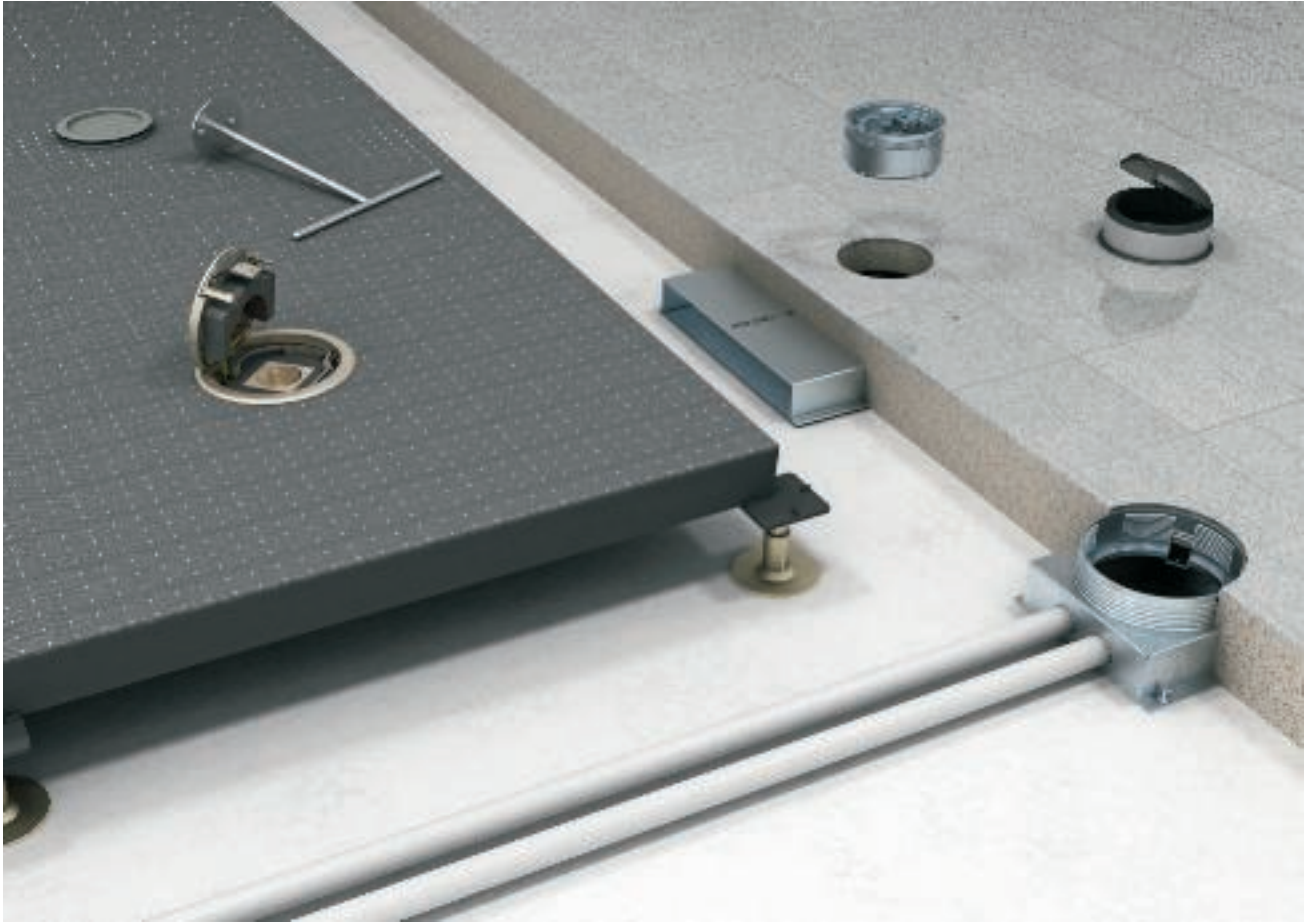



GESRM2 complete solutions

	GESRM2 service outlet, for installation in UDL	GESRM2 service outlet with protective frame Mounting plate for data technology	26 26
	Underfloor connection socket UDL	Underfloor outlet socket Height expansion	27 27
	GESRM2 service outlet, for cavity floor installation	RESRM2 service outlet with protective frame Mounting plate for data technology	28 28

GESRM2 service outlet, for installation in UDL



GESRM2 service outlet with protective frame for UZD/UDL, nickel-plated

Type	Pack.	Weight	Item No.
	pcs	kg/100 pcs.	
GESRN2 USB UK	1	72,300	7405 70 9

Zn Die-cast zinc **N** Nickel-plated /pc.

Round service outlet with switched single socket (BS). This version has a floor covering protection frame and can be installed in screed floors in connection with a UZD underfloor junction and branch box or a UDL2-120 connection socket. The minimum installation depth is 70 mm. When closed, the installation unit can be wet-cleaned Test.

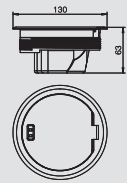

GESRM2 service outlet with protective frame for UZD/UDL, chrome-plated

Type	Pack.	Weight	Item No.
	pcs	kg/100 pcs.	
GESRC2 USB UK	1	72,300	7405 59 7

Zn Die-cast zinc **CR** Chrome-plated /pc.

Round service outlet with switched single socket (BS). This version has a floor covering protection frame and can be installed in screed floors in connection with a UZD underfloor junction and branch box or a UDL2-120 connection socket. The minimum installation depth is 70 mm. When closed, the installation unit can be wet-cleaned Test.

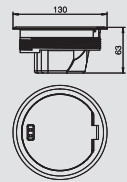

GESRM2 service outlet with protective frame for UZD/UDL, brass-plated

Type	Pack.	Weight	Item No.
	pcs	kg/100 pcs.	
GESRMS2 USB UK	1	72,300	7405 66 2

Zn Die-cast zinc **CuZn** Brass-coated /pc.

Round service outlet with switched single socket (BS). This version has a floor covering protection frame and can be installed in screed floors in connection with a UZD underfloor junction and branch box or a UDL2-120 connection socket. The minimum installation depth is 70 mm. When closed, the installation unit can be wet-cleaned Test.

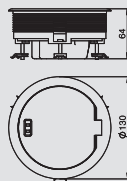

GESRM2 service outlet with protective frame for UZD/UDL, copper-plated

Type	Pack.	Weight	Item No.
	pcs	kg/100 pcs.	
GESRK2 USB UK	1	72,300	7405 63 3

Zn Die-cast zinc **Cu** Copper-plated /pc.

Round service outlet with switched single socket (BS). This version has a floor covering protection frame and can be installed in screed floors in connection with a UZD underfloor junction and branch box or a UDL2-120 connection socket. The minimum installation depth is 70 mm. When closed, the installation unit can be wet-cleaned Test.

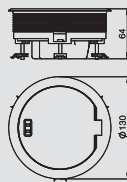

Mounting plate for data connection

Type	Pack.	Weight	Item No.
	pcs	kg/100 pcs.	
MPR2 2LJU6C	1	30,000	7407 62 1

St Steel **FS** Strip-galvanised /pc.

For the installation of two data modules of the type LJU6C in service outlet GESRM2. Dimension of the assembly opening in mm: 36.2 x 22.

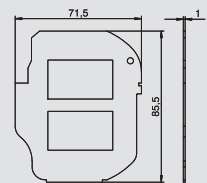

Underfloor connection socket UDL

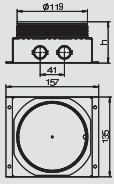

Underfloor outlet box for GESRM2 mounting

Type	Pack.	Weight	Item No.
	pcs	kg/100 pcs.	
UDL2-120 70 UK	1	80,300	7408 55 9

St Steel **FS** Strip-galvanised /pc.

Underfloor outlet socket for installation of a GESRM2 service outlet. With 2x2 openings for pipe installations M20 or Pg16.

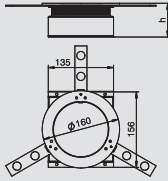
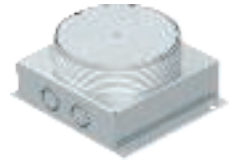

Underfloor outlet box, heavy-duty version, for GESRM2 mounting

Type	Pack.	Weight	Item No.
	pcs	kg/100 pcs.	
UDL1-120 70SL UK	1	116,000	7408 55 5

St Steel **FS** Strip-galvanised /pc.

Underfloor outlet socket for installation of a GESRM2 service outlet. Version for heavy-duty areas. With additional support ring and three screed anchors. Box body with 2 x 2 openings for pipe installation M20 or Pg16.

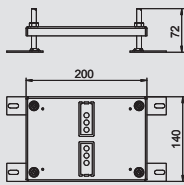
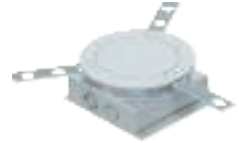

Height expansion for underfloor outlet socket UDL2-120

Type	Height adjustment range	Pack.	Weight	Item No.
		pcs	kg/100 pcs.	
HE60 UDL2-120 UK	10-60	1	78,300	7408 56 3

St Steel **FS** Strip-galvanised /pc.

Height-adjustable height expansion for underfloor outlet socket UDL2-120 and UDL1-120SL (up to 10 kN).

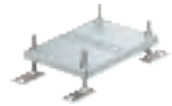

GESRM2 service outlet, for installation in cavity flooring



GESRM2 service outlet with protective frame for raised and cavity flooring, nickel-plated

Type	Pack.	Weight	Item No.
	pcs	kg/100 pcs.	
GESRN2 HS BSS UK	1	92,680	7428 03 3

Zn Die-cast zinc **N** Nickel-plated /pc.

Round service outlet with switched single socket (BS). This version has a floor cover protection frame and can be installed in raised and cavity floors. The minimum installation depth is 70 mm. When closed, the installation unit can be wet-cleaned.

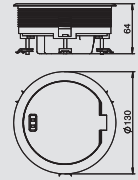

GESRM2 service outlet with protective frame for raised and cavity flooring, chrome-plated

Type	Pack.	Weight	Item No.
	pcs	kg/100 pcs.	
GESRC2 HS BSS UK	1	62,680	7428 03 5

Zn Die-cast zinc **CR** Chrome-plated /pc.

Round service outlet with switched single socket (BS). This version has a floor cover protection frame and can be installed in raised and cavity floors. The minimum installation depth is 70 mm. When closed, the installation unit can be wet-cleaned.

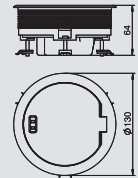

GESRM2 service outlet with protective frame for raised and cavity flooring, brass-plated

Type	Pack.	Weight	Item No.
	pcs	kg/100 pcs.	
GESRMS2 HS UK	1	92,680	7405 64 5

Zn Die-cast zinc **CuZn** Brass-coated /pc.

Round service outlet with switched single socket (BS). This version has a floor cover protection frame and can be installed in raised and cavity floors. The minimum installation depth is 70 mm. When closed, the installation unit can be wet-cleaned.

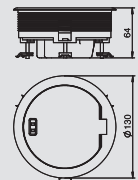

GESRM2 service outlet with protective frame for raised and cavity flooring, copper-plated

Type	Pack.	Weight	Item No.
	pcs	kg/100 pcs.	
GESRK2 HS UK	1	92,680	7405 62 1

Zn Die-cast zinc **Cu** Copper-plated /pc.

Round service outlet with switched single socket (BS). This version has a floor cover protection frame and can be installed in raised and cavity floors. The minimum installation depth is 70 mm. When closed, the installation unit can be wet-cleaned.

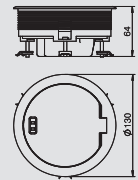

Mounting plate for data connection

Type	Pack.	Weight	Item No.
	pcs	kg/100 pcs.	
MPR2 2LJU6C	1	30,000	7407 62 1

St Steel **FS** Strip-galvanised /pc.

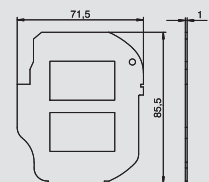

For the installation of two data modules of the type LJU6C in service outlet GESRM2. Dimension of the assembly opening in mm: 36.2 x 22.



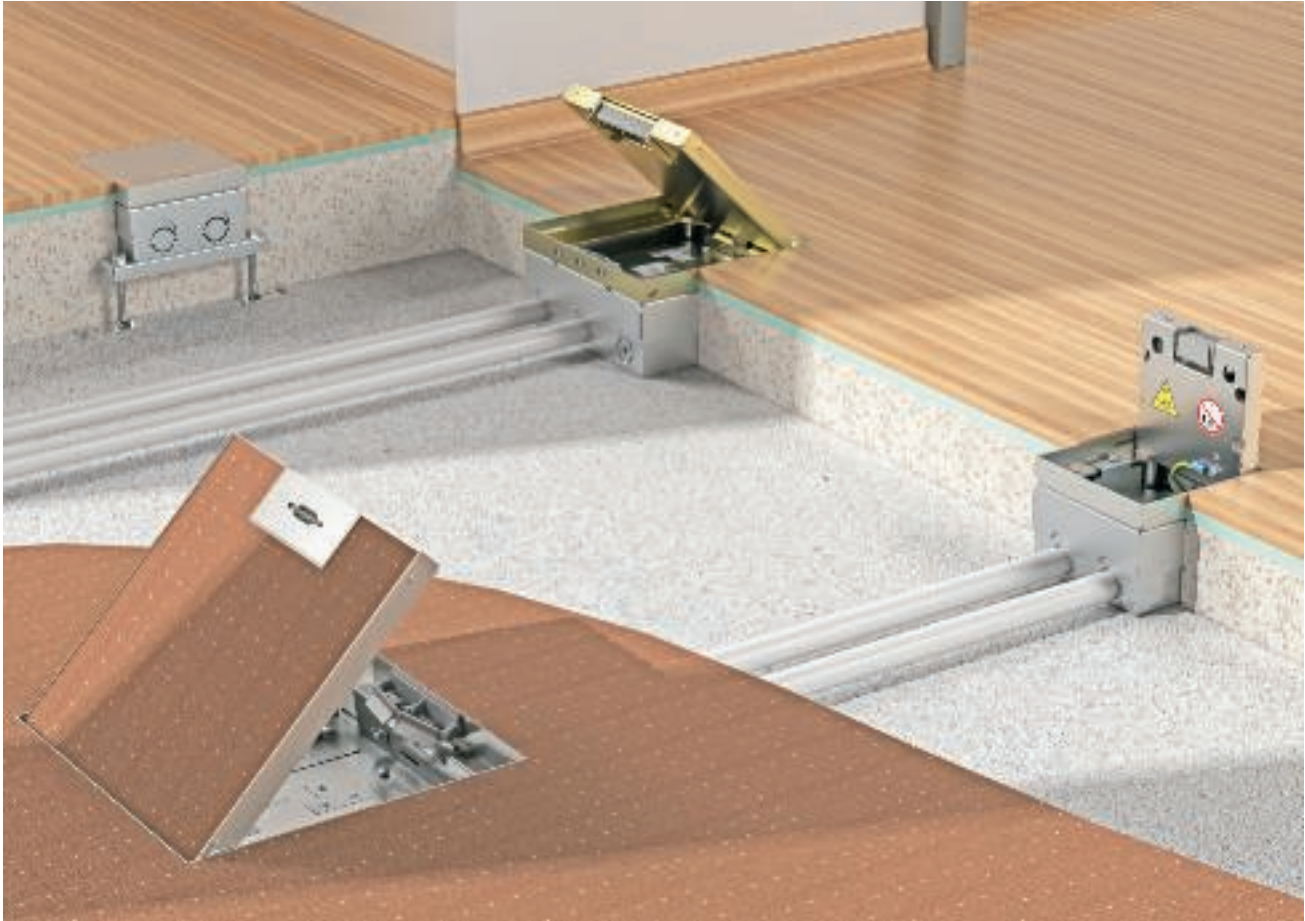



UDHome complete solutions

	UDHome2 service outlet, with BS socket	UDHome2 service outlet Height expansion	32 32
	UDHome4 service outlet, with BS socket	UDHome4 service outlet Height expansion	33 33
	UDHome9 service outlet, with BS socket	UDHome9 service outlet Height expansion	35 35

Complete GE2 service outlet without floor covering recess, with BS socket



GE2V service outlet without floor covering recess, with BS socket

Type	Dimension h mm	Installation depth mm	Floor height mm	Pack. pcs	Weight kg/100 pcs.	Item No.
UDHOME2 BV UK	95	75	75-95	1	185,000	7368 39 4

V2A Stainless steel, grade 305 **GUF** Brushed and laminated /pc.

Square installation unit for use in dry-care cavity and screed floors. Installation housing with pre-marked insertion openings for pipelines (M25). The parts visible in the floor covering are made of V2A or brass. The minimum installation depth is 95 mm, the height adjustment range + 20 mm.

The scope of delivery contains a single switched BS socket. Up to two modular data sockets (Keystones) can be installed with optional mounting supports. Surfaces visible in the floor covering made of: Brushed stainless steel.

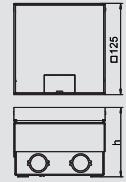

GE2V15 service outlet without floor covering recess, with BS socket



Type	Dimension h mm	Installation depth mm	Flooring depth mm	Floor height mm	Pack. pcs	Weight kg/100 pcs.	Item No.
UDHOME2 V UK	110	110	15	110-130	1	210,000	7368 38 1

V2A Stainless steel, grade 305 **GUF** Brushed and laminated /pc.

Square installation unit for use in dry-care cavity and screed floors. Installation housing with pre-marked insertion openings for pipelines (M25). Cover adjustable to the top edge of the floor covering using four height-adjustment supports. The minimum installation depth is 95 mm, the height adjustment range + 20 mm.

The scope of delivery contains a single switched BS socket. Up to two modular data sockets (Keystones) can be installed with optional mounting supports. Surfaces visible in the floor covering made of: Brushed stainless steel.

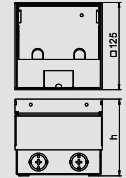

Height expansion for complete unit GE2



Type	Height adjustment range	Pack. pcs	Weight kg/100 pcs.	Item No.
HE60 UDHOME2 UK	10-60	1	73,400	7368 40 1

St Steel **FS** Strip-galvanised /pc.

Height-adjustable height expansion for complete unit UDHome2.

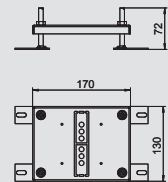

Complete UDHome4 service outlet, without socket

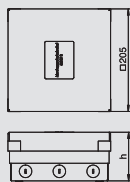

UDHOME4 2 stainless steel, with BS socket

Type	Dimension h mm	Screed height mm	Floor height mm	Flooring depth mm	Pack. pcs	Weight kg/100 pcs.	Item No.
UDHome4 2V UK	95	95-110	95-125	15	1	384,000	7427 23 3

V2A Stainless steel, grade 304 /pc.

Square installation unit for use in dry-care cavity and screed floors. Installation housing with pre-marked insertion openings for pipelines (M25). Cover adjustable to the top edge of the floor covering using four height-adjustment supports. 15 mm floor covering recess in the hinged lid. The minimum installation depth is 95 mm, the height adjustment range + 30 mm. The scope of delivery contains a MT 4R4 mounting support with a double BS socket, (AP MT2 2SS0). Surfaces visible in the floor covering made of: Stainless steel.

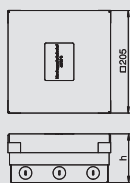

UDHOME4 2 stainless steel, with BS socket

Type	Dimension h mm	Screed height mm	Floor height mm	Flooring depth mm	Pack. pcs	Weight kg/100 pcs.	Item No.
UDHome4 2M UK	95	95-110	95-125	15	1	344,800	7427 23 7

CuZn Brass /pc.

Square installation unit for use in dry-care cavity and screed floors. Installation housing with pre-marked insertion openings for pipelines (M25). Cover adjustable to the top edge of the floor covering using four height-adjustment supports. 15 mm floor covering recess in the hinged lid. The minimum installation depth is 95 mm, the height adjustment range + 30 mm. The scope of delivery contains a MT 4R4 mounting support with a double BS socket, (AP MT2 2SS0). Surfaces visible in the floor covering made of: Brass.

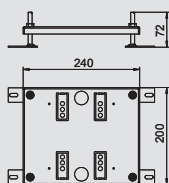

Height expansion for complete unit UDHome4

Type	Height adjustment range	Pack. pcs	Weight kg/100 pcs.	Item No.
HE60 UDHome4 UK	10-60	1	109,800	7427 44 1

St Steel FS Strip-galvanised /pc.

Height-adjustable height expansion for complete unit UDHome4.



Installation device AP MT2



Cover plate APMT2/0

Type	Length	Pack.	Weight	Item No.
	mm	pcs	kg/100 pcs.	
AP MT2 0 UK	163	20	12,300	7406 93 0

St Steel **FSO** Strip galvanised/organically coated /pc.
For blanking locking on an unused compartment in an MT AP2 mounting support.

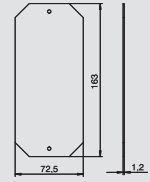

Cover plate APMT2/1

Type	Length	Pack.	Weight	Item No.
	mm	pcs	kg/100 pcs.	
AP MT2 1 UK	163	20	11,100	7406 93 1

St Steel **FSO** Strip galvanised/organically coated /pc.
Cover plate for mounting support MT AP2 for the installation of 4 data connection sockets of the design LJU6C.

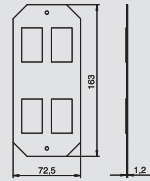

Cover plate APMT2 with single socket

Type	Colour	Length	Pack.	Weight	Item No.
		mm	pcs	kg/100 pcs.	
AP MT2 BS SSO	Grey-white	163	4	17,700	7407 87 6

St Steel **FSO** Strip galvanised/organically coated /pc.
Cover plate with a switched single socket for installation in mounting supports beneath GES installation units and cassettes. Socket with increased contact protection with screw connection, 3-pole, 13 A, 250 V~, corresponds to BS 1363.

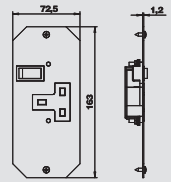

Cover plate APMT2 with two single sockets

Type	Colour	Length	Pack.	Weight	Item No.
		mm	pcs	kg/100 pcs.	
AP MT2 BS 2xSSO	Grey-white	163	4	23,700	7407 87 9

St Steel **FSO** Strip galvanised/organically coated /pc.
Cover plate with two switched single sockets for installation in mounting supports beneath GES installation units and cassettes. Sockets with increased contact protection with screw connection, 3-pole, 13 A, 250 V~, corresponds to BS 1363.

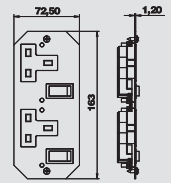

Cover plate APMT2 with double socket

Type	Colour	Length	Pack.	Weight	Item No.
		mm	pcs	kg/100 pcs.	
AP MT2 BS 2SSO	Grey-white	163	4	21,500	7407 87 2

St Steel **FSO** Strip galvanised/organically coated /pc.
Cover plate with a switched double socket for installation in mounting supports beneath GES installation units and cassettes. Socket with increased contact protection with screw connection, 3-pole, 13 A, 250 V~, corresponds to BS 1363.

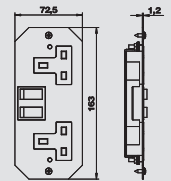

Complete UDHome9 service outlet, without socket

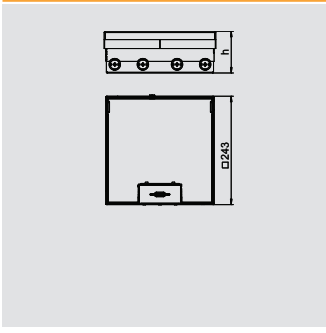

UDHome9 2 stainless steel, with BS socket

Type	Dimension h mm	Screed height mm	Floor height mm	Flooring depth mm	Pack. pcs	Weight kg/100 pcs.	Item No.
UDHome9 2V UK	95	95-110	95-125	15	1	470,000	7427 32 5

V2A Stainless steel, grade 304 /pc.

Square installation unit for use in dry-care cavity and screed floors. Installation housing with pre-marked insertion openings for pipelines (M25). The parts visible in the floor covering are made of V2A or brass. 15 mm floor covering recess in the hinged lid. The minimum installation depth is 95 mm, the height adjustment range + 30 mm.

The scope of delivery contains a MT 9R9 mounting support with a double BS socket, (AP MT5 2SS0). Surfaces visible in the floor covering made of: Stainless steel.

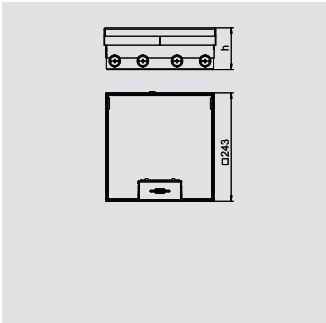

UDHOME9 2 brass, with BS socket

Type	Dimension h mm	Screed height mm	Floor height mm	Flooring depth mm	Pack. pcs	Weight kg/100 pcs.	Item No.
UDHome9 2M UK	95	95-110	95-125	15	1	482,000	7427 32 9

CuZn Brass /pc.

Square installation unit for use in dry-care cavity and screed floors. Installation housing with pre-marked insertion openings for pipelines (M25). Cover adjustable to the top edge of the floor covering using four height-adjustment supports. 15 mm floor covering recess in the hinged lid. The minimum installation depth is 95 mm, the height adjustment range + 30 mm.

The scope of delivery contains a MT 9R9 mounting support with a double BS socket, (AP MT5 2SS0). Surfaces visible in the floor covering made of: Brass.

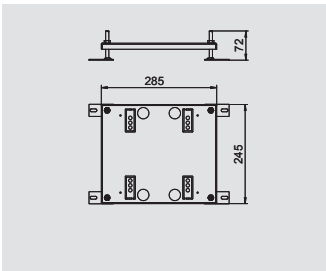
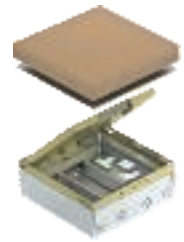

Height expansion for complete unit UDHome9

Type	Height adjustment range	Pack. pcs	Weight kg/100 pcs.	Item No.
HE60 UDHome9 UK	10-60	1	145,700	7427 44 5

St Steel FS Strip-galvanised /pc.

Height-adjustable height expansion for complete unit UDHome9.



Installation device AP MT5



Cover plate APMT5/0

Type	Length	Pack.	Weight	Item No.
	mm	pcs	kg/100 pcs.	
AP MT5 0 UK	181.5	20	12,700	7406 90 3

St Steel **FSO** Strip galvanised/organically coated /pc.
For blanking locking on an unused compartment in an MT AP2 mounting support.

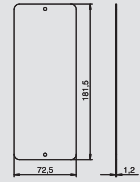

Cover plate APMT5/1

Type	Length	Pack.	Weight	Item No.
	mm	pcs	kg/100 pcs.	
AP MT5 1 UK	181.5	40	12,700	7406 88 4

St Steel **FSO** Strip galvanised/organically coated /pc.
Cover plate for mounting support MT AP5 for the installation of 4 data connection sockets of the design LJU6C.

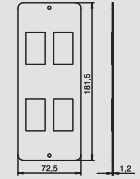

Cover plate APMT5 with single socket

Type	Colour	Length	Pack.	Weight	Item No.
		mm	pcs	kg/100 pcs.	
AP MT5 BS SSO	Grey-white	181.5	4	18,700	7407 87 4

St Steel **FSO** Strip galvanised/organically coated /pc.
Cover plate with a switched single socket for installation in mounting supports beneath GES installation units and cassettes. Socket with increased contact protection with screw connection, 3-pole, 13 A, 250 V~, corresponds to BS 1363.

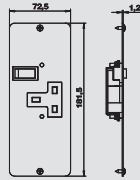

Cover plate APMT5 with two single sockets

Type	Colour	Length	Pack.	Weight	Item No.
		mm	pcs	kg/100 pcs.	
AP MT5 BS 2xSSO	Grey-white	181.5	4	25,300	7407 87 8

St Steel **FSO** Strip galvanised/organically coated /pc.
Cover plate with two switched single sockets for installation in mounting supports beneath GES installation units and cassettes. Sockets with increased contact protection with screw connection, 3-pole, 13 A, 250 V~, corresponds to BS 1363.

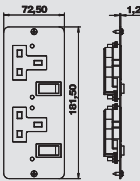

Cover plate APMT5 with double socket

Type	Colour	Length	Pack.	Weight	Item No.
		mm	pcs	kg/100 pcs.	
AP MT5 BS 2SSO	Grey-white	181.5	4	23,200	7407 87 0

St Steel **FSO** Strip galvanised/organically coated /pc.
Cover plate with a switched double socket MK14374D1WHI for installation in mounting supports beneath GES installation units and cassettes. Socket with increased contact protection with screw connection, 3-pole, 13 A, 250 V~, corresponds to BS 1363.

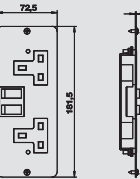



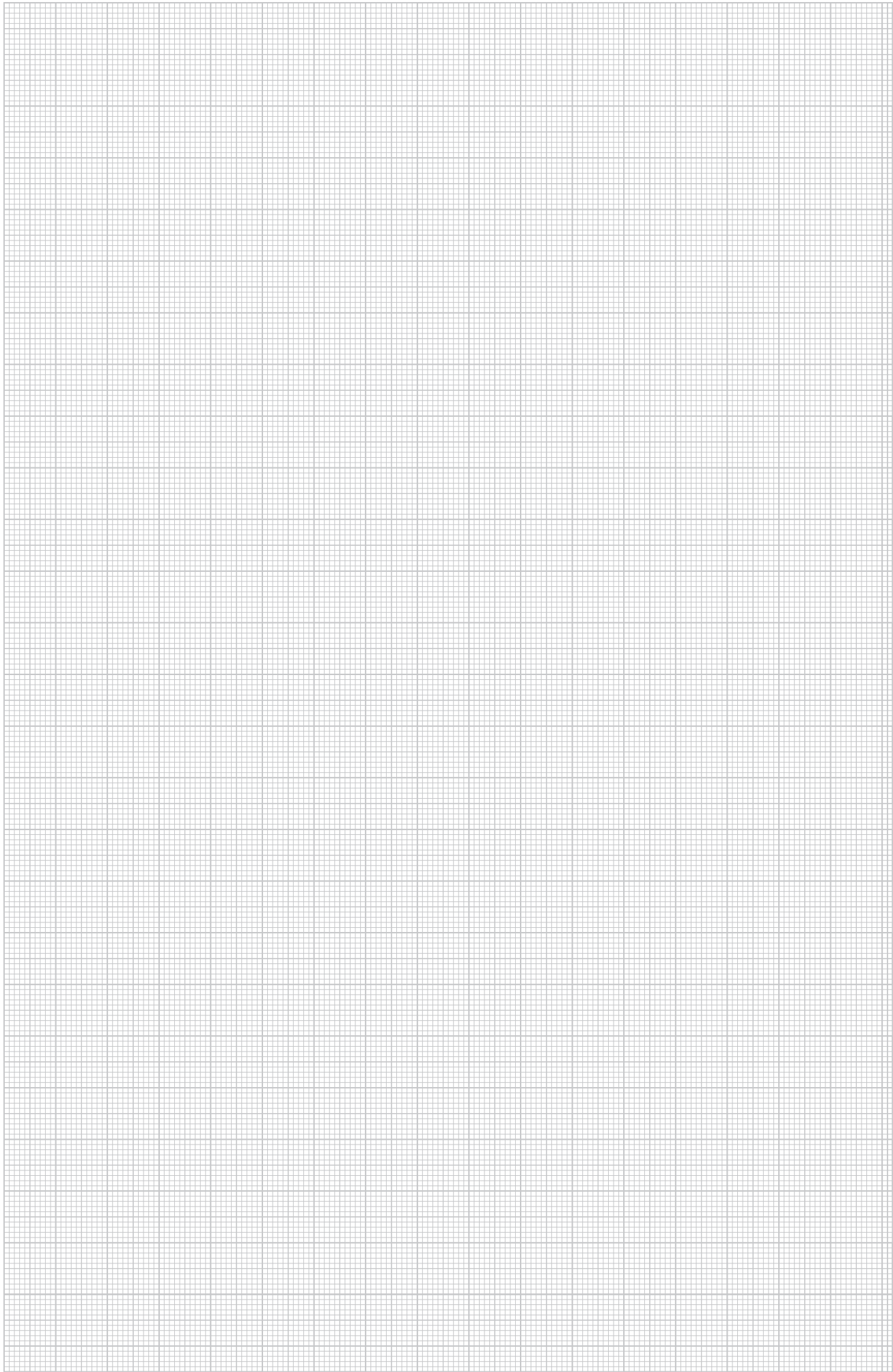

www.obo-bettermann.co.uk



OBO Bettermann Ltd

Unit 13
Finepoint Way
Minster Road
Kidderminster
DY11 7FB
Great Britain

THINK CONNECTED.