

Knightsbridge®

Knightsbridge®  
the mark of quality

LIGHTING & WIRING ACCESSORIES 2016

[www.mlaccessories.co.uk](http://www.mlaccessories.co.uk)





What an exciting year 2015 was! Three industry awards and one national award, increased growth and further investment into all departments without exception, coupled with the introduction of hundreds of new and innovative products, and even more planned for 2016, which we are excited to feature in this, our biggest and best catalogue yet.

The introduction of our new 'Track & Trace' feature has further enhanced our Next Day Delivery Service, offering our customers the ability to track their delivery in real time! As always, our skilled personnel, whether here or overseas, are here to support you with our unparalleled customer service – which continues to be envied throughout the industry.

As always, we appreciate this could not have been achieved without the tremendous loyalty and support from all our valued customers, which we can assure you, is never taken for granted.

With sincere thanks and warmest regards

**Arie Rosenfeld**  
Founder and Chairman



## **Best Customer Service 2015 Best Overall Supplier 2015**

We are the extremely proud winners of Best Supplier Customer Service and Best Overall Supplier of the UK Electrical Wholesalers Awards 2015 voted for by our customers.



## **Top 1000 Companies Award Winner**

**ML Accessories are proud to be one of the 1000 Companies to Inspire Britain (London Stock Exchange).**

Renowned for identifying the UK's stand-out businesses of the year, ML Accessories are honoured to receive an award for being one of the 1000 companies to inspire Britain. In a time of economical struggle for the country, we look to people and businesses for energy and inspiration to achieve our potential and we are overwhelmed to be identified as one. Here at ML Accessories, customers are our biggest drive and our passion is the fuel.



# We're only a click away.

K-Direct is a quick and reliable home delivery service that provides next day delivery (across mainland UK) with a no minimum order value or quantity. Simply place your customer's order online and have it delivered direct on your behalf. Cut out the time spent double handling and order exactly what you want without having to order minimum product quantities. Don't let logistics stand in the way of you and our fantastic products - order with K-Direct and ensure a professional, fast and efficient delivery service.

- **No minimum order value**
- **No minimum box quantity**
- **Fast, efficient and professional**
- **Next day delivery (across mainland UK)**
- **Created for our wholesalers to satisfy their customers.**

Our newly redesigned responsive website ensures, however you access our products, your experience is quick and hassle free.



## Quality products, first class delivery



# 2016 Contents

<b>Pure Range</b>	<b>5 - 17</b>
<b>Screwless Range</b>	<b>19 - 37</b>
<b>Flat Plate Range</b>	<b>39 - 57</b>
<b>Specialist Sockets</b>	<b>58 - 59</b>
<b>Standard Range</b>	<b>61 - 68</b>
<b>Datacomms</b>	<b>69 - 78</b>
<b>Wiring Accessories</b>	<b>79 - 89</b>
<b>Weatherproof</b>	<b>90 - 92</b>
<b>Metal Clad</b>	<b>93 - 98</b>
<b>Industrial Accessories</b>	<b>99 - 100</b>
<b>Tools</b>	<b>101 - 102</b>
<b>Test Equipment</b>	<b>103 - 106</b>
<b>Ventilation</b>	<b>107 - 109</b>
<b>Door Chimes</b>	<b>110 - 111</b>
<b>Detection Series</b>	<b>112 - 114</b>
<b>Sensors</b>	<b>115 - 118</b>
<b>Fire-rated Downlights</b>	<b>119 - 130</b>
<b>Decorative Downlights</b>	<b>131 - 137</b>
<b>Low Energy Display Lighting</b>	<b>139 - 150</b>
<b>Decorative Lighting</b>	<b>153 - 160</b>
<b>Bathroom</b>	<b>161 - 168</b>
<b>Commercial Lighting</b>	<b>169 - 189</b>
<b>Bulkheads</b>	<b>191 - 200</b>
<b>Floodlights</b>	<b>201 - 208</b>
<b>Outdoor Lighting</b>	<b>209 - 227</b>
<b>Emergency Lighting</b>	<b>229 - 234</b>
<b>Lamps and Transformers</b>	<b>235 - 249</b>
<b>Index</b>	<b>251 - 274</b>

## Brilliant service,

staff are always very quick to respond to any problems or requests.

ML Accessories always go the extra mile with customer service and their products are without doubt at the

## cutting edge

of what's needed now and for tomorrow.

MLA are the "go to" company for any information regarding electrical goods. We always get an

## immediate response and first class customer service.

One of the **most efficient** companies I have worked with in over 20 years in the business



## ML Accessories are a class apart!

**Brilliant service and great communication.**

**A delightful company to work with.**

## ML Accessories are a fantastic company to deal with

on every level great people, great products and great service. Would highly recommend.

The staff are always polite with a happy manner and spot on technical knowledge, extremely helpful company with

Working with MLA is a breath of fresh air, nothing is too much trouble for them. They have an incredible and constantly growing range of products, their stock levels are exceptional and their

**service is second to none.**

If only all suppliers were this good.

## 10/10 service

# PURE<sup>®</sup>

## WIRING ACCESSORIES

### Section Index

<b>PURE WIRING ACCESSORIES</b>	
Introduction	6
Sockets with USB	7
Sockets	8
Switches	9
Dimmers	10
Fused Spurs and Flex Outlets	11
45A Cooker Sockets and Switches	12
Media	13
<b>PURE 4mm SLIMLINE</b>	
Slimline Sockets	14
Slimline Switches, Dimmers and Media	15
Pattress Boxes	16
Point of Sale	17



Pg 7



# PURE<sup>®</sup>



## WIRING ACCESSORIES



British design and style...  
exclusive to Knightsbridge<sup>®</sup>

The PURE series from Knightsbridge<sup>®</sup> is a unique and exclusive range of white wiring accessories created to offer that little extra in terms of function and design:

- Sleek and slim design with gently concaved switch detail
- An elegant blend of straight edges and curves
- USB charging facility available on models **PU9901** and **PU9902**
- Available in 9mm retrofit and 4mm slimline versions
- High quality construction
- Designed and registered in the UK
- Fully compliant to relevant British Standards
- Compliments and enhances all interior décor with its neutral white finish
- 15 year guarantee

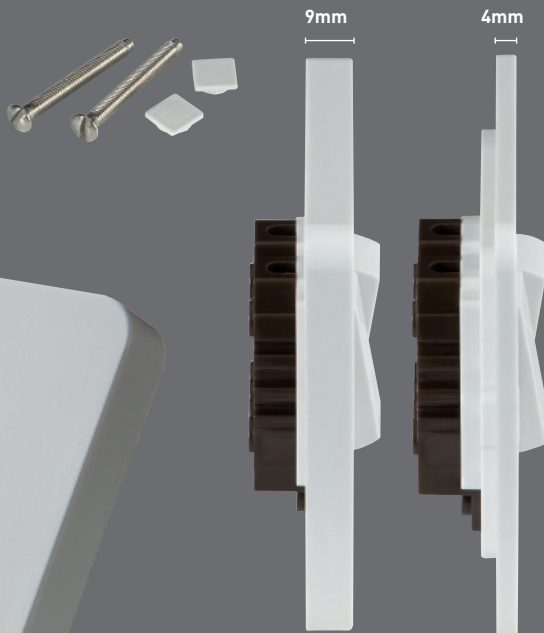



## PURE: SOCKETS WITH USB



PU9902



PU9901



### PURE SWITCHED SOCKETS WITH USB CHARGING FACILITY

Ideal for charging smartphones, tablets, digital cameras, MP3 players, hand-held games consoles and much more. 1G single or 2G dual USB charging ports. Enables you to charge any portable USB device without losing the use of the wall socket. Fits a standard 35mm back box and comes complete with fixing screws and screw cap covers.

Code	Model	Qty
PU9901	13A 1G DP switched socket with single USB charging outlet 5VDC 1A	1
PU9902	13A 2G DP switched socket with dual USB charging outlets 5VDC 2A (2 x 1000mA)	1
PU9SPACER	2G 12mm Spacer For use with 2G Pure Products	1



# PURE: SOCKETS



PU7000U



PU7000



PU7000N



PU5U



PU9000U



PU2U



PU9000



PU8900



PU9000N



**PURE white moulded wall accessories with a 15 year guarantee**

- Durable, scratch resistant thermoset material
- Double pole (DP) switches where stated
- Complete with fixing screws and covers
- British 1G faceplate size 86 x 86mm
- British 2G faceplate size 146 x 86mm
- Fully compliant to relevant British Standards

Code	Model	Qty
<b>PU7000U</b>	13A 1G Unswitched socket	1
<b>PU7000</b>	13A 1G DP Switched socket	1
<b>PU7000N</b>	13A 1G DP Switched socket with neon	1
<b>PU9000U</b>	13A 2G Unswitched socket	1
<b>PU9000</b>	13A 2G DP Switched socket	1
<b>PU9000N</b>	13A 2G DP Switched socket with neons	1
<b>PU2U</b>	2A Unswitched round pin socket	1
<b>PU5U</b>	5A Unswitched round pin socket	1
<b>PU8900</b>	Dual voltage shaver socket	2

## PURE: SWITCHES

**PURE**  
WIRING ACCESSORIES



P1200M

All PURE 10A plate switches 9mm and 4mm have an interchangeable modular design. An intermediate module P1200M can be purchased separately enabling an intermediate position to be placed on a 2G, 4G or 6G plate making them a truly versatile solution.



PU2000



PU3000



PU4000

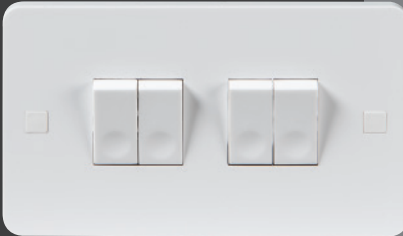

PU4100

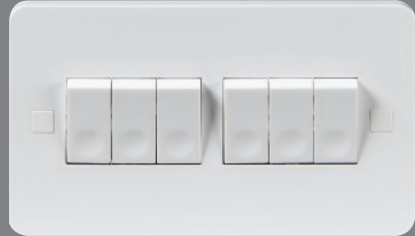

PU4200



PU1100



PU8341N



PU8341F

Code	Model	Qty	Code	Model	Qty
PU2000	10A 1G 2 Way switch	1	P1200M	10A Intermediate module	1
PU3000	10A 2G 2 Way switch	1	PU1100	10A Fan isolator switch	1
PU4000	10A 3G 2 Way switch	1	PU8341	20A DP Switch	1
PU4100	10A 4G 2 Way switch	1	PU8341N	20A DP Switch with neon	1
PU4200	10A 6G 2 Way switch	1	PU8341F	20A DP Switch with neon and flex outlet	1
PU1200	10A 1G Intermediate switch	1			

## PURE: DIMMERS



PU2161



PU2162

### PURE Dimmers

- Push on/push off switch action
- Suitable for mains lighting, low voltage lighting and LED lighting
- Fully compliant to relevant British Standards



PU2163

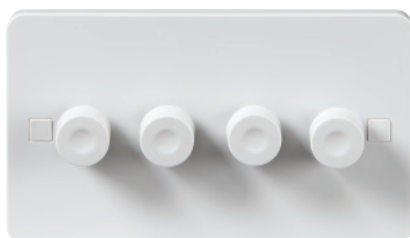

PU2164

Code	Model	Qty
<b>PU2161</b>	1G 40-400W Dimmer*	1
<b>PU2162</b>	2G 40-400W Dimmer*	1
<b>PU2163</b>	3G 40-250W Dimmer*	1
<b>PU2164</b>	4G 40-250W Dimmer*	1

\*Always check with LED lamp manufacturer for compatibility.



## PURE: FUSED SPURS AND FLEX OUTLETS



PU6000



PU6000N



PU6000F



PU6300



PU6300N



PU6300F



PU8342



PURE fused spur units come with an in-built fuse.

- Double pole (DP) switches
- Complete with fixing screws and covers
- British 1G faceplate size 86 x 86mm
- Fully compliant to relevant British Standards

Code	Model	Qty
<b>PU6000</b>	13A Fused spur	1
<b>PU6000N</b>	13A Fused spur with neon	1
<b>PU6000F</b>	13A Fused spur with neon and flex outlet	1
<b>PU6300</b>	13A Switched fused spur	1
<b>PU6300N</b>	13A Switched fused spur with neon	1
<b>PU6300F</b>	13A Switched fused spur with neon and flex outlet	1
<b>PU8342</b>	20A Flex outlet (centre exit)	1

# PURE: 45A COOKER SOCKETS AND SWITCHES



PU8332N



PU8331N



PU8340

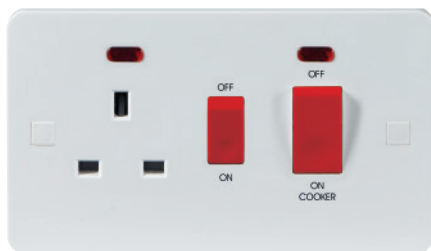

PU8333N

PURE 45A series of cooker switches, sockets and connection plates.

- Complete with twin earth lugs
- Double pole (DP) switches
- Clear on/off markings
- Complete with fixing screws and covers
- Fits into standard 47mm deep back box (1G - **SG147**, 2G - **SG247**)
- Fully compliant to relevant British Standards



Code	Model	Qty
<b>PU8331</b>	45A 1G DP Switch	1
<b>PU8331N</b>	45A 1G DP Switch with neon	1
<b>PU8332</b>	45A 2G DP Switch	1
<b>PU8332N</b>	45A 2G DP Switch with neon	1
<b>PU8333</b>	45A 2G DP Switch and 13A DP switched socket	1
<b>PU8333N</b>	45A 2G DP Switch and 13A DP switched socket with neons	1
<b>PU8340</b>	45A 1G Cooker cable connection unit	1





PU0100



PU0140



PU0130



PU7300/PU7400



PU8350

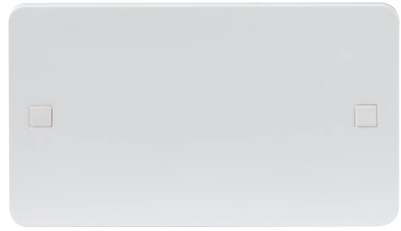

PU8360

PURE media outlet plates for TV, telecom and blanking requirements.

- Isolated and non-isolated outlets
- Telephone outlets with IDC termination
- Complete with fixing screws and covers
- British 1G faceplate size 86 x 86mm
- British 2G faceplate size 146 x 86mm
- Fully compliant to relevant British Standards



Code	Model	Qty
PU0100	1G TV Outlet (non-isolated)	1
PU0130	1G TV and FM outlet (isolated)	1
PU0140	1G TV and SAT outlet (isolated)	1
PU7300	1G Telephone master socket (IDC)	1
PU7400	1G Telephone extension socket (IDC)	1
PU8350	1G Blanking plate	10
PU8360	2G Blanking plate	5



# PURE SLIMLINE 4MM: SOCKETS



PS9000



PS7000

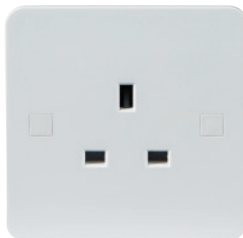

PS7000U



PS7000N



## PURE SLIMLINE SERIES

The PURE slimline series has been designed to be as ultra-thin as possible. At just 4mm depth, these models allow for a truly minimalistic finish.

- Sockets and dimmers require a 35mm back box
- Switches and media outlets require a 25mm back box
- Fully compliant to relevant British Standards



PS9000U



PS9000N

Code	Model	Qty
PS7000	13A 1G DP Switched socket	1
PS7000U	13A 1G Unswitched socket	1
PS7000N	13A 1G DP Switched socket with neon	1
PS9000	13A 2G DP Switched socket	1
PS9000U	13A 2G Unswitched socket	1
PS9000N	13A 2G DP Switched socket with neons	1



# PURE SLIMLINE 4MM: SWITCHES, DIMMERS AND MEDIA



PS2000



PS3000



PS4000

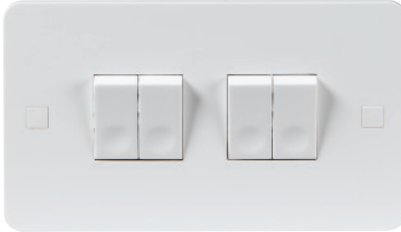

PS4100



PS2161

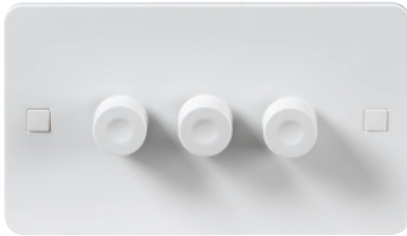

PS2163

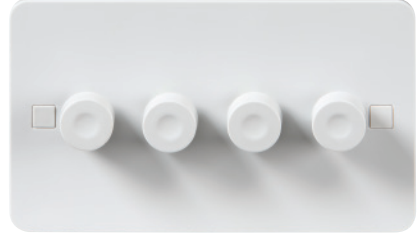

PS2164



PS0100



PS7300/PS7400



Code	Model	Qty
PS2000	10A 1G 2 Way switch	1
PS3000	10A 2G 2 Way switch	1
PS4000	10A 3G 2 Way switch	1
PS4100	10A 4G 2 Way switch	1
PS4200	10A 6G 2 Way switch	1
PS1200	10A 1G Intermediate switch	1
PS2161	1G 40-400W Dimmer*	1
PS2162	2G 40-400W Dimmer*	1
PS2163	3G 40-250W Dimmer*	1

Code	Model	Qty
PS2164	4G 40-250W Dimmer*	1
PS0100	1G TV outlet	1
PS0130	1G TV and FM outlet	1
PS0140	1G TV and SAT outlet	1
PS7300	1G Telephone master socket (IDC)	1
PS7400	1G Telephone extension socket (IDC)	1
P1200M	10A Intermediate module	1

\*Always check with LED lamp manufacturer for compatibility.

# PURE: PATTRRESS BOXES



PU1300



PU1400



PU1700



PU1610



PU1500



PU1600



PU1800

Designed exclusively for the PURE series.

Code	Model	Depth	Qty
PU1300	1G Pattress box with earth terminal	16mm	10
PU1400	1G Pattress box	25mm	10
PU1700	1G Pattress box with earth terminal	35mm	10
PU1610	1G Pattress box with earth terminal	47mm	10
PU1500	2G Pattress box	25mm	10
PU1800	2G Pattress box with earth terminal	35mm	10
PU1600	2G Pattress box with earth terminal	47mm	10



EXCLUSIVE TO **Knightsbridge** the mark of quality

**PURE** WIRING ACCESSORIES

The complete PURE range includes: Sockets | Switches | Dimmers | Spurs and flex outlets | 4SA switches | Media | Pattress boxes

www.mlaccessories.co.uk

PURE 15 YEAR WARRANTY

ML ACCESSORIES

CE

PUREPOSHB



PUREPOSDTU

PUREPOSA5

PURE POINT OF SALE

PURE point of sale is only available to PURE stockists.

To become a stockist of PURE® wiring accessories call the ML Accessories sales office for details or contact your ML Accessories area sales manager to arrange an appointment.

Code	Model	Qty
PUREPOSHB	1.5m header board	1
PUREPOSA3	A3 poster	1
PUREPOSDTU	Countertop display unit with pre-installed display product	1
PUREPOSDB	Wall mount display board with pre-installed display product	1
PUREPOSA5CAT	A5 product catalogue	1

EXCLUSIVE TO **Knightsbridge** the mark of quality

**PURE** WIRING ACCESSORIES

The complete PURE range includes:  
Sockets | Switches | Dimmers | Spurs and flex outlets | 4SA switches | Media | Pattress boxes  
Low profile 9mm retrofit plates  
Selected models available in 6mm slimline

IN STOCK NOW

www.mlaccessories.co.uk

PURE 15 YEAR WARRANTY

ML ACCESSORIES

CE

PUREPOSA3

EXCLUSIVE TO **Knightsbridge** the mark of quality

**PURE** WIRING ACCESSORIES

Gently concaved switch detail  
Clean edges and curved corners  
Low profile 9mm retrofit plates

High quality construction  
British, patented design  
Fully compliant to the latest relevant British Standards

www.mlaccessories.co.uk

PURE 15 YEAR WARRANTY

PUREPOSDB

VISION  
PROCESS  
CUSTOMER  
INDUSTRY  
ADVERTISING  
WAREHOUSE  
MANAGEMENT  
QUALITY  
ACTION  
SUCCESS  
TARGET  
CUSTOMER  
SERVICES  
AFTERSALES  
FULFILMENT  
DEVELOPMENT  
INNOVATION  
DATA  
EMBRACING  
TECHNOLOGY

**Knightsbridge**<sup>®</sup>  
the mark of quality

**2,500 PRODUCTS**

DATA  
STRATEGY  
INDUSTRY  
TARGET  
CREATIVITY  
JOBS  
MARKET  
INSIGHT  
TRAINING  
DEVELOPMENT  
NATIONAL SALES  
AND ACCOUNT  
MANAGEMENT  
CAREERS  
MANAGEMENT  
JOB  
PLAN  
PROMOTION  
PRODUCT  
DEVELOPMENT  
STRATEGY  
BUSINESS  
VISION  
INDUSTRY  
TARGET



**Switch ON**

to one of the UK's fastest growing businesses

# SCREWLESS

## SWITCHES & SOCKETS

### Section Index

Introduction	20
13A Sockets	21
13A Sockets with USB	22-23
5A Sockets	24
10A Switches	25-26
Toggle Switches	27-28
Dimmers	29
Fused Spurs	30
20A Switches	31
45A Switches and Sockets	32
Media	33-34
115V/230V Shaver Sockets	35
Blanking Plates	36
Modular Faceplates	36-37
Point of Sale	37

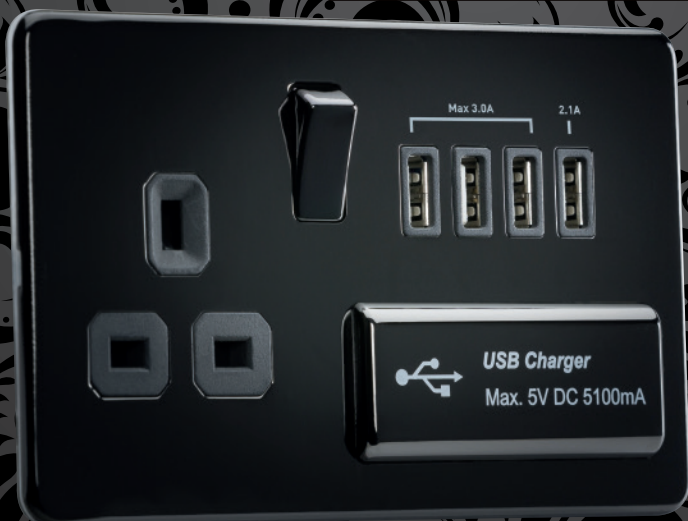

P23

# SCREWLESS

SWITCHES & SOCKETS



Available in 5 alluring finishes, with an ultra slim profile design, incorporating matching metal rockers and high quality metallic switches. The screwless design features an easy clip on cover, and integral moisture gasket. Constructed from premium grade components.

- Available in Brushed Chrome, Polished Chrome, Black Nickel, Polished Brass and Matt Black
- Manufactured to all the relevant British Safety Standards.
- Available with either black or white socket inserts\*.
- Backed up with our 15 year guarantee.

\* Matt black only available with black insert



SF4GBC

Modular inserts available pages 70-72

## SCREWLESS: 13A SOCKETS

THE MINIMUM MOUNTING DEPTH FOR PRODUCTS ON THIS PAGE IS 25MM



**13A 1G DP SWITCHED SOCKET - BLACK INSERT**

Code	Finish	Qty
SF7000PC	Polished chrome	1
SF7000BC	Brushed chrome	1
SF7000PB	Polished brass	1
SF7000BN	Black nickel	1
SF7000MB	Matt black	1



**13A 1G DP SWITCHED SOCKET - WHITE INSERT**

Code	Finish	Qty
SF7000PCW	Polished chrome	1
SF7000BCW	Brushed chrome	1
SF7000PBW	Polished brass	1
SF7000BNW	Black nickel	1

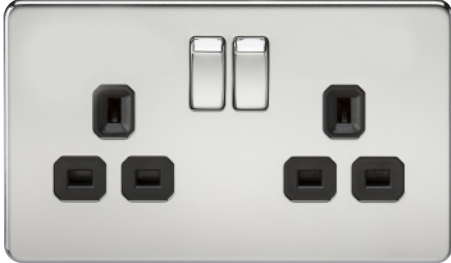

**13A 2G DP SWITCHED SOCKET - BLACK INSERT**

Code	Finish	Qty
SF9000PC	Polished chrome	1
SF9000BC	Brushed chrome	1
SF9000PB	Polished brass	1
SF9000BN	Black nickel	1
SF9000MB	Matt black	1

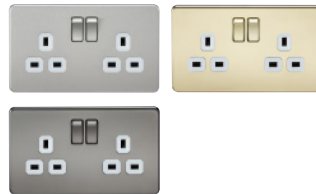
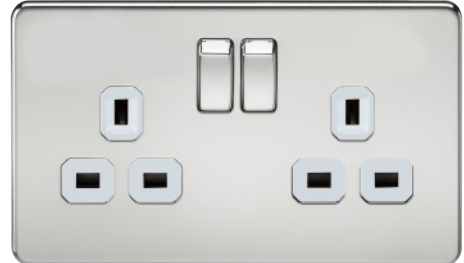

**13A 2G DP SWITCHED SOCKET - WHITE INSERT**

Code	Finish	Qty
SF9000PCW	Polished chrome	1
SF9000BCW	Brushed chrome	1
SF9000PBW	Polished brass	1
SF9000BNW	Black nickel	1

# SCREWLESS: 13A SOCKETS WITH USB

THE MINIMUM MOUNTING DEPTH FOR PRODUCTS ON THIS PAGE IS 25MM



**13A 1G SWITCHED SOCKET - BLACK INSERT  
DUAL USB CHARGER - 5V DC 2.1A (SHARED)**

Code	Finish	Qty
SF9901PC	Polished chrome	1
SF9901BC	Brushed chrome	1
SF9901PB	Polished brass	1
SF9901BN	Black nickel	1
SF9901MB	Matt black	1



**13A 1G SWITCHED SOCKET - WHITE INSERT  
DUAL USB CHARGER - 5V DC 2.1A (SHARED)**

Code	Finish	Qty
SF9901PCW	Polished chrome	1
SF9901BCW	Brushed chrome	1
SF9901PBW	Polished brass	1
SF9901BNW	Black nickel	1

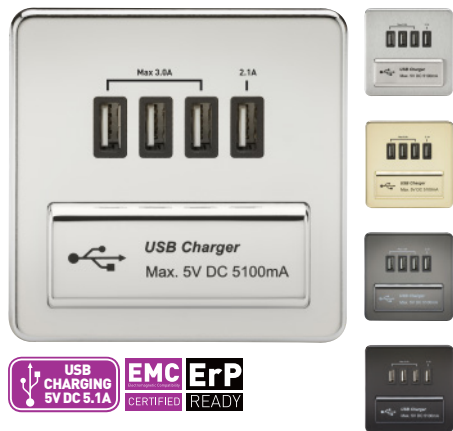

**1G QUAD USB CHARGER OUTLET  
- BLACK INSERT - 5V DC 5.1A**

Code	Finish	Qty
SFQUADPC	Polished chrome	1
SFQUADBC	Brushed chrome	1
SFQUADPB	Polished brass	1
SFQUADBN	Black nickel	1
SFQUADMB	Matt black	1

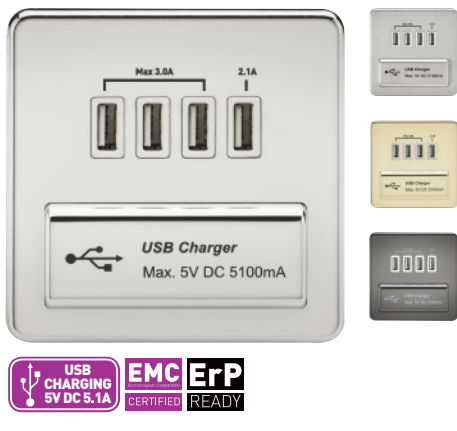

**1G QUAD USB CHARGER OUTLET  
- WHITE INSERT - 5V DC 5.1A**

Code	Finish	Qty
SFQUADPCW	Polished chrome	1
SFQUADBCW	Brushed chrome	1
SFQUADPBW	Polished brass	1
SFQUADBNW	Black nickel	1

**NB: If your cable entry is from centre base, you may need to adjust cable entry**



# SCREWLESS: 13A SOCKETS WITH USB

THE MINIMUM MOUNTING DEPTH FOR PRODUCTS ON THIS PAGE IS 25MM

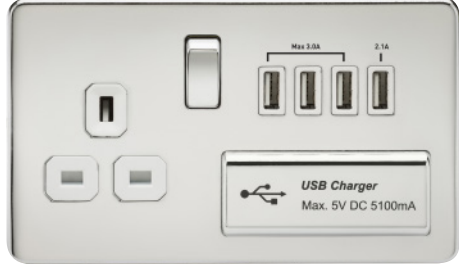
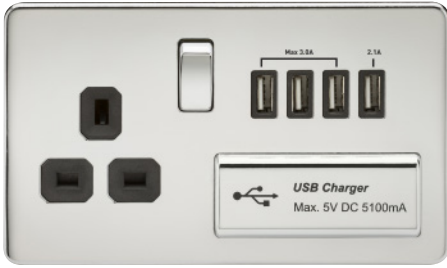

**13A 1G SWITCHED SOCKET - BLACK INSERT  
QUAD USB CHARGER - 5V DC 5.1A**

**13A 1G SWITCHED SOCKET - WHITE INSERT  
QUAD USB CHARGER - 5V DC 5.1A**

Code	Finish	Qty
SF7USB4PC	Polished chrome	1
SF7USB4BC	Brushed chrome	1
SF7USB4PB	Polished brass	1
SF7USB4BN	Black nickel	1
SF7USB4MB	Matt black	1

Code	Finish	Qty
SF7USB4PCW	Polished chrome	1
SF7USB4BCW	Brushed chrome	1
SF7USB4PBW	Polished brass	1
SF7USB4BNW	Black nickel	1



**13A 2G SWITCHED SOCKET - BLACK INSERT  
DUAL USB CHARGER - 5V DC 2.1A (SHARED)**

**13A 2G SWITCHED SOCKET - WHITE INSERT  
DUAL USB CHARGER - 5V DC 2.1A (SHARED)**

Code	Finish	Qty
SF9902PC	Polished chrome	1
SF9902BC	Brushed chrome	1
SF9902PB	Polished brass	1
SF9902BN	Black nickel	1
SF9902MB	Matt black	1

Code	Finish	Qty
SF9902PCW	Polished chrome	1
SF9902BCW	Brushed chrome	1
SF9902PBW	Polished brass	1
SF9902BNW	Black nickel	1

**NB: If your cable entry is from centre base, you may need to adjust cable entry**

## SCREWLESS: 5A SOCKETS

THE MINIMUM MOUNTING DEPTH FOR PRODUCTS ON THIS PAGE IS 25MM



### 5A 1G ROUND PIN SOCKET - BLACK INSERT

Code	Finish	Qty
SF5APC	Polished chrome	1
SF5ABC	Brushed chrome	1
SF5APB	Polished brass	1
SF5ABN	Black nickel	1
SF5AMB	Matt black	1

### 5A 1G ROUND PIN SOCKET - WHITE INSERT

Code	Finish	Qty
SF5APCW	Polished chrome	1
SF5ABCW	Brushed chrome	1
SF5APBW	Polished brass	1
SF5ABNW	Black nickel	1



## SCREWLESS: 10A SWITCHES

THE MINIMUM MOUNTING DEPTH FOR PRODUCTS ON THIS PAGE IS 16MM



### 10A 3 POLE FAN ISOLATOR SWITCH

Code	Finish	Qty
SF1100PC	Polished chrome	1
SF1100BC	Brushed chrome	1
SF1100PB	Polished brass	1
SF1100BN	Black nickel	1
SF1100MB	Matt black	1



### 10A 1G INTERMEDIATE SWITCH

Code	Finish	Qty
SF1200PC	Polished chrome	1
SF1200BC	Brushed chrome	1
SF1200PB	Polished brass	1
SF1200BN	Black nickel	1
SF1200MB	Matt black	1



### 10A 1G 2 WAY SWITCH

Code	Finish	Qty
SF2000PC	Polished chrome	1
SF2000BC	Brushed chrome	1
SF2000PB	Polished brass	1
SF2000BN	Black nickel	1
SF2000MB	Matt black	1



### 10A 2G 2 WAY SWITCH

Code	Finish	Qty
SF3000PC	Polished chrome	1
SF3000BC	Brushed chrome	1
SF3000PB	Polished brass	1
SF3000BN	Black nickel	1
SF3000MB	Matt black	1

## SCREWLESS: 10A SWITCHES

THE MINIMUM MOUNTING DEPTH FOR PRODUCTS ON THIS PAGE IS 16MM

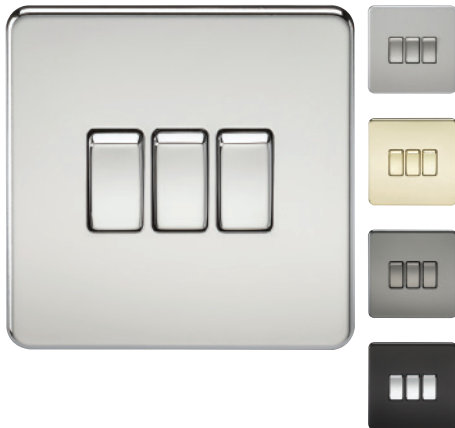

### 10A 3G 2 WAY SWITCH

Code	Finish	Qty
SF4000PC	Polished chrome	1
SF4000BC	Brushed chrome	1
SF4000PB	Polished brass	1
SF4000BN	Black nickel	1
SF4000MB	Matt black	1



### 10A 4G 2 WAY SWITCH

Code	Finish	Qty
SF4100PC	Polished chrome	1
SF4100BC	Brushed chrome	1
SF4100PB	Polished brass	1
SF4100BN	Black nickel	1
SF4100MB	Matt black	1



### 10A 6G 2 WAY SWITCH

Code	Finish	Qty
SF4200PC	Polished chrome	1
SF4200BC	Brushed chrome	1
SF4200PB	Polished brass	1
SF4200BN	Black nickel	1
SF4200MB	Matt black	1

## SCREWLESS: TOGGLE SWITCHES

THE MINIMUM MOUNTING DEPTH FOR PRODUCTS ON THIS PAGE IS 16MM



### 10A 1G 2 WAY TOGGLE SWITCH

Code	Finish	Qty
SF1TOGPC	Polished chrome	1
SF1TOGBC	Brushed chrome	1
SF1TOGPB	Polished brass	1
SF1TOGBN	Black nickel	1
SF1TOGMB	Matt black	1



### 10A 1G INTERMEDIATE TOGGLE SWITCH

Code	Finish	Qty
SF12TOGPC	Polished chrome	1
SF12TOGBC	Brushed chrome	1
SF12TOGPB	Polished brass	1
SF12TOGBN	Black nickel	1
SF12TOGMB	Matt black	1



### 10A 2G 2 WAY TOGGLE SWITCH

Code	Finish	Qty
SF2TOGPC	Polished chrome	1
SF2TOGBC	Brushed chrome	1
SF2TOGPB	Polished brass	1
SF2TOGBN	Black nickel	1
SF2TOGMB	Matt black	1



## SCREWLESS: TOGGLE SWITCHES

THE MINIMUM MOUNTING DEPTH FOR PRODUCTS ON THIS PAGE IS 16MM



### 10A 3G 2 WAY TOGGLE SWITCH

Code	Finish	Qty
SF3TOGPC	Polished chrome	1
SF3TOGBC	Brushed chrome	1
SF3TOGPB	Polished brass	1
SF3TOGBN	Black nickel	1
SF3TOGMB	Matt black	1

### 10A 4G 2 WAY TOGGLE SWITCH

Code	Finish	Qty
SF4TOGPC	Polished chrome	1
SF4TOGBC	Brushed chrome	1
SF4TOGPB	Polished brass	1
SF4TOGBN	Black nickel	1
SF4TOGMB	Matt black	1

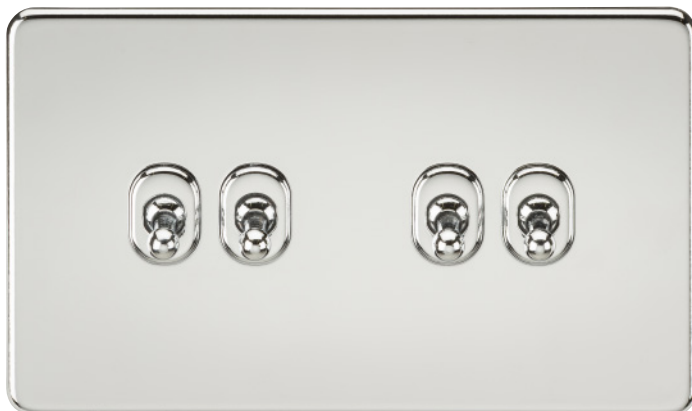

## SCREWLESS: DIMMERS

THE MINIMUM MOUNTING DEPTH FOR PRODUCTS ON THIS PAGE IS 25MM



**1G 2 WAY DIMMER 60-400W**

Code	Finish	Qty
SF2161PC	Polished chrome	1
SF2161BC	Brushed chrome	1
SF2161PB	Polished brass	1
SF2161BN	Black nickel	1
SF2161MB	Matt black	1



**2G 2 WAY DIMMER 60-400W**

Code	Finish	Qty
SF2162PC	Polished chrome	1
SF2162BC	Brushed chrome	1
SF2162PB	Polished brass	1
SF2162BN	Black nickel	1
SF2162MB	Matt black	1



**3G 2 WAY DIMMER 60-400W**

Code	Finish	Qty
SF2163PC	Polished chrome	1
SF2163BC	Brushed chrome	1
SF2163PB	Polished brass	1
SF2163BN	Black nickel	1
SF2163MB	Matt black	1



**4G 2 WAY DIMMER 60-400W**

Code	Finish	Qty
SF2164PC	Polished chrome	1
SF2164BC	Brushed chrome	1
SF2164PB	Polished brass	1
SF2164BN	Black nickel	1
SF2164MB	Matt black	1

## SCREWLESS: FUSED SPURS

THE MINIMUM MOUNTING DEPTH FOR PRODUCTS ON THIS PAGE IS 25MM



### 13A 1G FUSED SPUR UNIT

Code	Finish	Qty
SF6000PC	Polished chrome	1
SF6000BC	Brushed chrome	1
SF6000PB	Polished brass	1
SF6000BN	Black nickel	1
SF6000MB	Matt black	1



### 13A 1G FUSED SPUR UNIT WITH NEON

Code	Finish	Qty
SF6000NPC	Polished chrome	1
SF6000NBC	Brushed chrome	1
SF6000NPB	Polished brass	1
SF6000NBN	Black nickel	1
SF6000NMB	Matt black	1



### 13A 1G SWITCHED FUSED SPUR UNIT

Code	Finish	Qty
SF6300PC	Polished chrome	1
SF6300BC	Brushed chrome	1
SF6300PB	Polished brass	1
SF6300BN	Black nickel	1
SF6300MB	Matt black	1



### 13A 1G SWITCHED FUSED SPUR UNIT WITH NEON

Code	Finish	Qty
SF6300NPC	Polished chrome	1
SF6300NBC	Brushed chrome	1
SF6300NPB	Polished brass	1
SF6300NBN	Black nickel	1
SF6300NMB	Matt black	1



## SCREWLESS: 20A SWITCHES

THE MINIMUM MOUNTING DEPTH FOR PRODUCTS ON THIS PAGE IS 25MM



### 20A 1G DP SWITCH

Code	Finish	Qty
SF8341PC	Polished chrome	1
SF8341BC	Brushed chrome	1
SF8341PB	Polished brass	1
SF8341BN	Black nickel	1
SF8341MB	Matt black	1



### 20A 1G DP SWITCH WITH NEON

Code	Finish	Qty
SF8341NPC	Polished chrome	1
SF8341NBC	Brushed chrome	1
SF8341NPB	Polished brass	1
SF8341NBN	Black nickel	1
SF8341NMB	Matt black	1



# SCREWLESS: 45A SWITCHES AND SOCKETS

THE MINIMUM MOUNTING DEPTH FOR PRODUCTS ON THIS PAGE IS 47MM

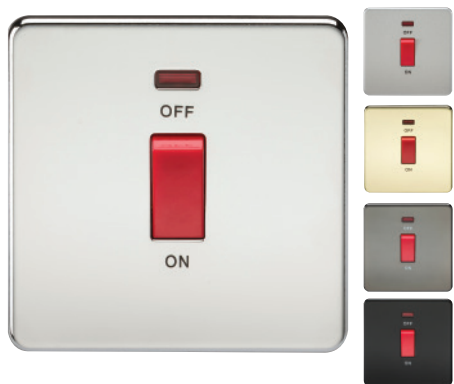

## 45A 1G DP SWITCH WITH NEON

Code	Finish	Qty
SF8331NPC	Polished chrome	1
SF8331NBC	Brushed chrome	1
SF8331NPB	Polished brass	1
SF8331NBN	Black nickel	1
SF8331NMB	Matt black	1

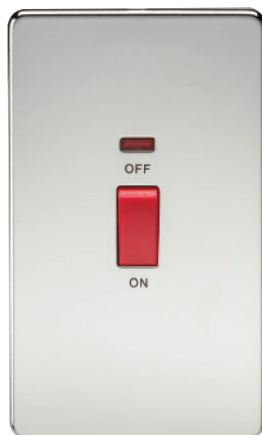

## 45A 2G DP SWITCH WITH NEON

Code	Finish	Qty
SF8332NPC	Polished chrome	1
SF8332NBC	Brushed chrome	1
SF8332NPB	Polished brass	1
SF8332NBN	Black nickel	1
SF8332NMB	Matt black	1



## 45A 2G DP SWITCH AND 13A DP SWITCHED SOCKET WITH NEONS - BLACK INSERT

Code	Finish	Qty
SF8333NPC	Polished chrome	1
SF8333NBC	Brushed chrome	1
SF8333NPB	Polished brass	1
SF8333NBN	Black nickel	1
SF8333NMB	Matt black	1



## 45A 2G DP SWITCH AND 13A DP SWITCHED SOCKET WITH NEONS - WHITE INSERT

Code	Finish	Qty
SF8333NPCW	Polished chrome	1
SF8333NBCW	Brushed chrome	1
SF8333NPBW	Polished brass	1
SF8333NBNW	Black nickel	1

## SCREWLESS: MEDIA

THE MINIMUM MOUNTING DEPTH FOR PRODUCTS ON THIS PAGE IS 25MM

Telephone - Screw terminal

Network - IDC terminal



### TELEPHONE MASTER SOCKET

Code	Finish	Qty
SF7300PC	Polished chrome	1
SF7300BC	Brushed chrome	1
SF7300PB	Polished brass	1
SF7300BN	Black nickel	1
SF7300MB	Matt black	1

### TELEPHONE EXTENSION SOCKET

Code	Finish	Qty
SF7400PC	Polished chrome	1
SF7400BC	Brushed chrome	1
SF7400PB	Polished brass	1
SF7400BN	Black nickel	1
SF7400MB	Matt black	1

### RJ45 IDC NETWORK OUTLET

Code	Finish	Qty
SFRJ45PC	Polished chrome	1
SFRJ45BC	Brushed chrome	1
SFRJ45PB	Polished brass	1
SFRJ45BN	Black nickel	1
SFRJ45MB	Matt black	1

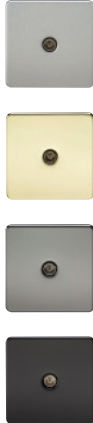

### 1G TV COAX OUTLET (NON-ISOLATED)

Code	Finish	Qty
SF0100PC	Polished chrome	1
SF0100BC	Brushed chrome	1
SF0100PB	Polished brass	1
SF0100BN	Black nickel	1
SF0100MB	Matt black	1

### 1G SAT/TV OUTLET (ISOLATED)

Code	Finish	Qty
SF0140PC	Polished chrome	1
SF0140BC	Brushed chrome	1
SF0140PB	Polished brass	1
SF0140BN	Black nickel	1
SF0140MB	Black nickel	1

## SCREWLESS: MEDIA

THE MINIMUM MOUNTING DEPTH FOR PRODUCTS ON THIS PAGE IS 25MM



### 1G SAT/TV (NON-ISOLATED)

Code	Finish	Qty
SF0150PC	Polished chrome	1
SF0150BC	Brushed chrome	1
SF0150PB	Polished brass	1
SF0150BN	Black nickel	1
SF0150MB	Matt black	1

### 1G TV/ FM DAB SCREENED DUPLEX OUTLET

Code	Finish	Qty
SF0160PC	Polished chrome	1
SF0160BC	Brushed chrome	1
SF0160PB	Polished brass	1
SF0160BN	Black nickel	1
SF0160MB	Matt black	1



## SCREWLESS: 115V/230V SHAVER SOCKETS

THE MINIMUM MOUNTING DEPTH FOR PRODUCTS ON THIS PAGE IS 47MM

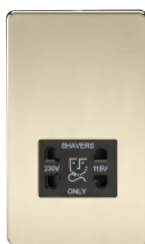

### 115V/230V DUAL VOLTAGE SHAVER SOCKET BLACK INSERT

Code	Finish	Qty
SF8900PC	Polished chrome	1
SF8900BC	Brushed chrome	1
SF8900PB	Polished brass	1
SF8900BN	Black nickel	1
SF8900MB	Matt black	1



### 115V/230V DUAL VOLTAGE SHAVER SOCKET WHITE INSERT

Code	Finish	Qty
SF8900PCW	Polished chrome	1
SF8900BCW	Brushed chrome	1
SF8900PBW	Polished brass	1
SF8900BNW	Black nickel	1



## SCREWLESS: BLANKING PLATES



### 1G BLANKING PLATE

Code	Finish	Qty
SF8350PC	Polished chrome	1
SF8350BC	Brushed chrome	1
SF8350PB	Polished brass	1
SF8350BN	Black nickel	1
SF8350MB	Matt black	1

### 2G BLANKING PLATE

Code	Finish	Qty
SF8360PC	Polished chrome	1
SF8360BC	Brushed chrome	1
SF8360PB	Polished brass	1
SF8360BN	Black nickel	1
SF8360MB	Matt black	1

## SCREWLESS: MODULAR FACEPLATES

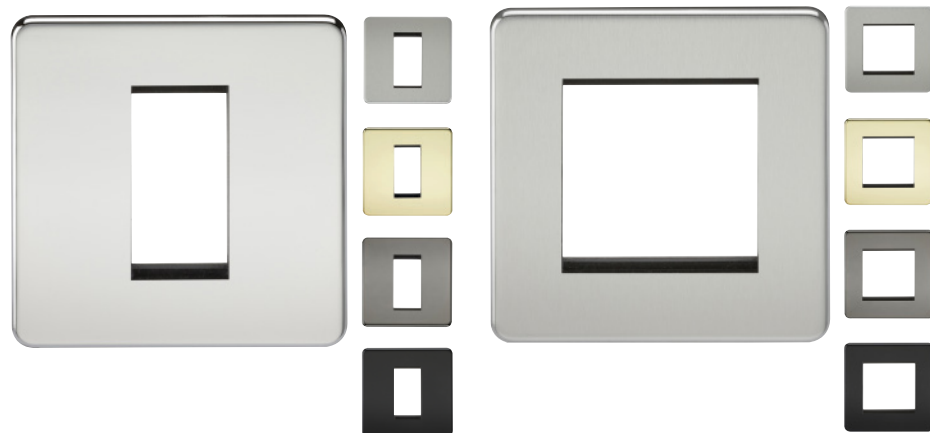

### 1G MODULAR FACEPLATE

Code	Finish	Qty
SF1GPC	Polished chrome	1
SF1GBC	Brushed chrome	1
SF1GPB	Polished brass	1
SF1GBN	Black nickel	1
SF1GMB	Matt black	1

### 2G MODULAR FACEPLATE

Code	Finish	Qty
SF2GPC	Polished chrome	1
SF2GBC	Brushed chrome	1
SF2GPB	Polished brass	1
SF2GBN	Black nickel	1
SF2GMB	Matt black	1

## SCREWLESS: MODULAR FACEPLATES



### 4G MODULAR FACEPLATE

Code	Finish	Qty
SF4GPC	Polished chrome	1
SF4GBC	Brushed chrome	1
SF4GPB	Polished brass	1



### 4G MODULAR FACEPLATE

Code	Finish	Qty
SF4GBN	Black nickel	1
SF4GMB	Matt black	1

SCREWLESS point of sale is only available to stockists. To become an exclusive stockist of SCREWLESS wiring accessories® call the ML Accessories sales office for details or contact your ML Accessories area sales manager to arrange an appointment.

Code	Model	Qty
SCREWA3	A3 poster	1
SCREWCTDU	Countertop display unit	1
SCREWDB	Wall mount display board with pre-installed display product	1
SCREWA5	A5 product catalogue	1

### SCREWCTDU



### SCREWA5

## SCREWLESS: POINT OF SALE

### SCREWA3

**NEW**

**SCREWLESS SWITCHES & SOCKETS**

15 YEARS

Introducing the new nightsbridge® premium range of screwless switches & sockets. These ultra-slim, recessed items with rotating metal covers are standard for the exceptional A&P range.

Our switches are all to be as easy to use as ever, with user-friendly features, and are packed for convenient protection and installation from premium grade plastic and durable, high temperature resistant, fire-retardant panels.

This new range includes a guaranteed anti-kick double protection up to 100g and 100% energy friendly, 100% (DCC) SA. All together with technologically advanced, anti-glare or anti-glare finishes, optional, limited colour range, gold leaf, blue, red, and matt black and decorative in addition to the standard range.

Supplied in 100% recycled, wall-mounting with 60mm and 75mm depth for easy installation.

We look forward to your call on 01582 887740 or please email us at [ml@nightsbridge.co.uk](mailto:ml@nightsbridge.co.uk)

Next day delivery as standard throughout mainland UK. Availability may vary.

**nightsbridge**  
the mark of quality

ML

**SCREWLESS SWITCHES & SOCKETS**

15 YEARS

Available on:

**nightsbridge**  
the mark of quality

ML

**SCREWDB**



Passionate about customer service

**K**nightsbridge®  
the mark of quality

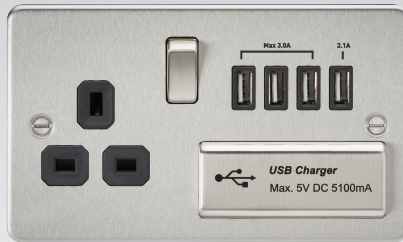

Excellence at no extra cost





# FLAT PLATE

switches and sockets

## Section Index

13A Sockets	40
13A Sockets with USB	41-42
5A Sockets	43
Floor Sockets	44
10A Switches	45-46
Dimmers	47
10A Toggle Switches	48-49
Fused Spurs	50
20A Switches	51
45A Switches and Sockets	52
Media	53-54
115V/230V Shaver Sockets	55
Blanking Plates	56
Modular Faceplates	57



P47



# FLAT PLATE: 13A SOCKETS

THE MINIMUM MOUNTING DEPTH FOR PRODUCTS ON THIS PAGE IS 25MM



**13A 1G DP SWITCHED SOCKET - BLACK INSERT**

Code	Finish	Qty
FP7000PC	Polished chrome	1
FP7000BC	Brushed chrome	1
FP7000PB	Polished brass	1
FP7000BB	Brushed brass	1
FP7000GM	Gunmetal	1



**13A 1G DP SWITCHED SOCKET - WHITE INSERT**

Code	Finish	Qty
FP7000PCW	Polished chrome	1
FP7000BCW	Brushed chrome	1
FP7000PLW	Pearl	1



**13A 2G DP SWITCHED SOCKET - BLACK INSERT**

Code	Finish	Qty
FP9000PC	Polished chrome	1
FP9000BC	Brushed chrome	1
FP9000PB	Polished brass	1
FP9000BB	Brushed brass	1
FP9000GM	Gunmetal	1



**13A 2G DP SWITCHED SOCKET - WHITE INSERT**

Code	Finish	Qty
FP9000PCW	Polished chrome	1
FP9000BCW	Brushed chrome	1
FP9000PLW	Pearl	1

# FLAT PLATE: 13A SOCKETS WITH USB

THE MINIMUM MOUNTING DEPTH FOR PRODUCTS ON THIS PAGE IS 25MM



## 13A 1G SWITCHED SOCKET - BLACK INSERT DUAL USB CHARGER - 5V DC 2.1A (SHARED)

Code	Finish	Qty
FP9901PC	Polished chrome	1
FP9901BC	Brushed chrome	1
FP9901PB	Polished brass	1
FP9901BB	Brushed brass	1
FP9901GM	Gunmetal	1

## 13A 1G SWITCHED SOCKET - WHITE INSERT DUAL USB CHARGER - 5V DC 2.1A (SHARED)

Code	Finish	Qty
FP9901PCW	Polished chrome	1
FP9901BCW	Brushed chrome	1
FP9901PLW	Pearl	1

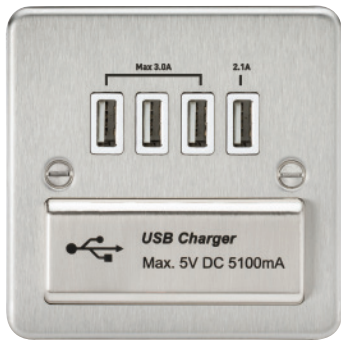
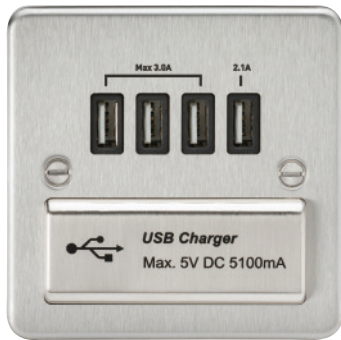

## 1G QUAD USB CHARGER OUTLET BLACK INSERT - 5V DC 5.1A

Code	Finish	Qty
FPQUADPC	Polished chrome	1
FPQUADBC	Brushed chrome	1
FPQUADPB	Polished brass	1
FPQUADBB	Brushed brass	1
FPQUADGM	Gunmetal	1

## 1G QUAD USB CHARGER OUTLET WHITE INSERT - 5V DC 5.1A

Code	Finish	Qty
FPQUADPCW	Polished chrome	1
FPQUADBCW	Brushed chrome	1
FPQUADPLW	Pearl	1

# FLAT PLATE: 13A SOCKETS WITH USB

THE MINIMUM MOUNTING DEPTH FOR PRODUCTS ON THIS PAGE IS 25MM

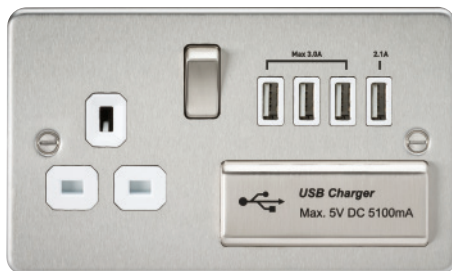

## 13A 1G SWITCHED SOCKET - BLACK INSERT QUAD USB CHARGER - 5V DC 5.1A

Code	Finish	Qty
FP7USB4PC	Polished chrome	1
FP7USB4BC	Brushed chrome	1
FP7USB4PB	Polished brass	1
FP7USB4BB	Brushed brass	1
FP7USB4GM	Gunmetal	1

## 13A 1G SWITCHED SOCKET - WHITE INSERT QUAD USB CHARGER - 5V DC 5.1A

Code	Finish	Qty
FP7USB4PCW	Polished chrome	1
FP7USB4BCW	Brushed chrome	1
FP7USB4PLW	Pearl	1



## 13A 2G SWITCHED SOCKET - BLACK INSERT DUAL USB CHARGER - 5V DC 2.1A (SHARED)

Code	Finish	Qty
FP9902PC	Polished chrome	1
FP9902BC	Brushed chrome	1
FP9902PB	Polished brass	1
FP9902BB	Brushed brass	1
FP9902GM	Gunmetal	1

## 13A 2G SWITCHED SOCKET - WHITE INSERT DUAL USB CHARGER - 5V DC 2.1A (SHARED)

Code	Finish	Qty
FP9902PCW	Polished chrome	1
FP9902BCW	Brushed chrome	1
FP9902PLW	Pearl	1

## FLAT PLATE: 5A SOCKETS

THE MINIMUM MOUNTING DEPTH FOR PRODUCTS ON THIS PAGE IS 25MM



### 5A 1G ROUND PIN SOCKET - BLACK INSERT

Code	Finish	Qty
FP5APC	Polished chrome	1
FP5ABC	Brushed chrome	1
FP5APB	Polished brass	1
FP5ABB	Brushed brass	1
FP5AGM	Gunmetal	1

### 5A 1G ROUND PIN SOCKET - WHITE INSERT

Code	Finish	Qty
FP5APCW	Polished chrome	1
FP5ABCW	Brushed chrome	1
FP5APLW	Pearl	1



## FLAT PLATE: FLOOR SOCKETS



FP7UBCW



FP7UBBW



FP7UPBW

Floor sockets require 47mm back box.

### 13A 1G UNSWITCHED FLOOR SOCKET

Dimensions: H: 95mm W: 95mm

Code	Finish	Qty
FP7UPCW	Polished chrome	1
FP7UBCW	Brushed chrome	1
FP7UPBW	Polished brass	1
FP7UBBW	Brushed brass	1

### 13A 2G UNSWITCHED FLOOR SOCKET

Dimensions: H: 95mm W: 140mm

Code	Finish	Qty
FP9UPCW	Polished chrome	1
FP9UBCW	Brushed chrome	1
FP9UPBW	Polished brass	1
FP9UBBW	Brushed brass	1



FP9UPCW

# FLAT PLATE: 10A SWITCHES

THE MINIMUM MOUNTING DEPTH FOR PRODUCTS ON THIS PAGE IS 16MM



## 10A 3 POLE FAN ISOLATOR SWITCH

Code	Finish	Qty
FP1100PC	Polished chrome	1
FP1100BC	Brushed chrome	1
FP1100PB	Polished brass	1
FP1100BB	Brushed brass	1
FP1100GM	Gunmetal	1
FP1100PL	Pearl	1

## 10A 1G INTERMEDIATE SWITCH

Code	Finish	Qty
FP1200PC	Polished chrome	1
FP1200BC	Brushed chrome	1
FP1200PB	Polished brass	1
FP1200BB	Brushed brass	1
FP1200GM	Gunmetal	1
FP1200PL	Pearl	1



## 10A 1G 2 WAY SWITCH

Code	Finish	Qty
FP2000PC	Polished chrome	1
FP2000BC	Brushed chrome	1
FP2000PB	Polished brass	1
FP2000BB	Brushed brass	1
FP2000GM	Gunmetal	1
FP2000PL	Pearl	1

## 10A 2G 2 WAY SWITCH

Code	Finish	Qty
FP3000PC	Polished chrome	1
FP3000BC	Brushed chrome	1
FP3000PB	Polished brass	1
FP3000BB	Brushed brass	1
FP3000GM	Gunmetal	1
FP3000PL	Pearl	1



## FLAT PLATE: 10A SWITCHES

THE MINIMUM MOUNTING DEPTH FOR PRODUCTS ON THIS PAGE IS 16MM



### 10A 3G 2 WAY SWITCH

Code	Finish	Qty
FP4000PC	Polished chrome	1
FP4000BC	Brushed chrome	1
FP4000PB	Polished brass	1
FP4000BB	Brushed brass	1
FP4000GM	Gunmetal	1
FP4000PL	Pearl	1



### 10A 4G 2 WAY SWITCH

Code	Finish	Qty
FP4100PC	Polished chrome	1
FP4100BC	Brushed chrome	1
FP4100PB	Polished brass	1
FP4100BB	Brushed brass	1
FP4100GM	Gunmetal	1
FP4100PL	Pearl	1



### 10A 6G 2 WAY SWITCH

Code	Finish	Qty
FP4200PC	Polished chrome	1
FP4200BC	Brushed chrome	1
FP4200PB	Polished brass	1
FP4200BB	Brushed brass	1
FP4200GM	Gunmetal	1
FP4200PL	Pearl	1



## FLAT PLATE: DIMMERS

THE MINIMUM MOUNTING DEPTH FOR PRODUCTS ON THIS PAGE IS 25MM



### 1G 2 WAY DIMMER 60-400W

Code	Finish	Qty
FP2161PC	Polished chrome	1
FP2161BC	Brushed chrome	1
FP2161PB	Polished brass	1
FP2161BB	Brushed brass	1
FP2161GM	Gunmetal	1
FP2161PL	Pearl	1



### 2G 2 WAY DIMMER 60-400W

Code	Finish	Qty
FP2162PC	Polished chrome	1
FP2162BC	Brushed chrome	1
FP2162PB	Polished brass	1
FP2162BB	Brushed brass	1
FP2162GM	Gunmetal	1
FP2162PL	Pearl	1

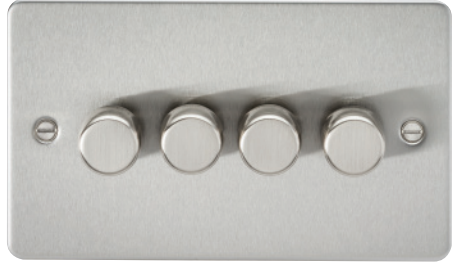

### 3G 2 WAY DIMMER 60-400W

Code	Finish	Qty
FP2163PC	Polished chrome	1
FP2163BC	Brushed chrome	1
FP2163PB	Polished brass	1
FP2163BB	Brushed brass	1
FP2163GM	Gunmetal	1
FP2163PL	Pearl	1

### 4G 2 WAY DIMMER 60-400W

Code	Finish	Qty
FP2164PC	Polished chrome	1
FP2164BC	Brushed chrome	1
FP2164PB	Polished brass	1
FP2164BB	Brushed brass	1
FP2164GM	Gunmetal	1
FP2164PL	Pearl	1

## FLAT PLATE: 10A TOGGLE SWITCHES

THE MINIMUM MOUNTING DEPTH FOR PRODUCTS ON THIS PAGE IS 16MM



### 10A 1G 2 WAY TOGGLE SWITCH

Code	Finish	Qty
FP1TOGPC	Polished chrome	1
FP1TOGBC	Brushed chrome	1
FP1TOGPB	Polished brass	1
FP1TOGGB	Brushed brass	1
FP1TOGGM	Gunmetal	1
FP1TOGPL	Pearl	1



### 10A 1G INTERMEDIATE TOGGLE SWITCH

Code	Finish	Qty
FP12TOGPC	Polished chrome	1
FP12TOGBC	Brushed chrome	1
FP12TOGPB	Polished brass	1
FP12TOGGB	Brushed brass	1
FP12TOGGM	Gunmetal	1
FP12TOGPL	Pearl	1



### 10A 2G 2 WAY TOGGLE SWITCH

Code	Finish	Qty
FP2TOGPC	Polished chrome	1
FP2TOGBC	Brushed chrome	1
FP2TOGPB	Polished brass	1
FP2TOGGB	Brushed brass	1
FP2TOGGM	Gunmetal	1
FP2TOGPL	Pearl	1



## FLAT PLATE: 10A TOGGLE SWITCHES

THE MINIMUM MOUNTING DEPTH FOR PRODUCTS ON THIS PAGE IS 16MM



### 10A 3G 2 WAY TOGGLE SWITCH

Code	Finish	Qty
FP3TOGPC	Polished chrome	1
FP3TOGBC	Brushed chrome	1
FP3TOGPB	Polished brass	1
FP3TOGBB	Brushed brass	1
FP3TOGGM	Gunmetal	1
FP3TOGPL	Pearl	1

### 10A 4G 2 WAY TOGGLE SWITCH

Code	Finish	Qty
FP4TOGPC	Polished chrome	1
FP4TOGBC	Brushed chrome	1
FP4TOGPB	Polished brass	1
FP4TOGBB	Brushed brass	1
FP4TOGGM	Gunmetal	1
FP4TOGPL	Pearl	1



## FLAT PLATE: FUSED SPURS

THE MINIMUM MOUNTING DEPTH FOR THE PRODUCTS ON THIS PAGE IS 25MM



### 13A FUSED SPUR UNIT

Code	Finish	Qty
FP6000PC	Polished chrome	1
FP6000BC	Brushed chrome	1
FP6000PB	Polished brass	1
FP6000BB	Brushed brass	1
FP6000GM	Gunmetal	1
FP6000PL	Pearl	1



### 13A FUSED SPUR UNIT WITH NEON

Code	Finish	Qty
FP6000NPC	Polished chrome	1
FP6000NBC	Brushed chrome	1
FP6000NPB	Polished brass	1
FP6000NBB	Brushed brass	1
FP6000NGM	Gunmetal	1
FP6000NPL	Pearl	1



### 13A SWITCHED FUSED SPUR UNIT

Code	Finish	Qty
FP6300PC	Polished chrome	1
FP6300BC	Brushed chrome	1
FP6300PB	Polished brass	1
FP6300BB	Brushed brass	1
FP6300GM	Gunmetal	1
FP6300PL	Pearl	1



### 13A SWITCHED FUSED SPUR UNIT WITH NEON

Code	Finish	Qty
FP6300NPC	Polished chrome	1
FP6300NBC	Brushed chrome	1
FP6300NPB	Polished brass	1
FP6300NBB	Brushed brass	1
FP6300NGM	Gunmetal	1
FP6300NPL	Pearl	1

### 13A SWITCHED FUSED SPUR UNIT WITH NEON AND FLEX OUTLET

Code	Finish	Qty
FP6300FPC	Polished chrome	1
FP6300FBC	Brushed chrome	1
FP6300FPB	Polished brass	1
FP6300FBB	Brushed brass	1
FP6300FGM	Gunmetal	1
FP6300FPL	Pearl	1



## FLAT PLATE: 20A SWITCHES

THE MINIMUM MOUNTING DEPTH FOR PRODUCTS ON THIS PAGE IS 25MM



### 20A 1G DP SWITCH

Code	Finish	Qty
FP8341PC	Polished chrome	1
FP8341BC	Brushed chrome	1
FP8341PB	Polished brass	1
FP8341BB	Brushed brass	1
FP8341GM	Gunmetal	1
FP8341PL	Pearl	1



### 20A 1G DP SWITCH WITH NEON

Code	Finish	Qty
FP8341NPC	Polished chrome	1
FP8341NBC	Brushed chrome	1
FP8341NPB	Polished brass	1
FP8341NBB	Brushed brass	1
FP8341NGM	Gunmetal	1
FP8341NPL	Pearl	1



### 20A 1G DP SWITCH WITH NEON & FLEX OUTLET

Code	Finish	Qty
FP8341FPC	Polished chrome	1
FP8341FBC	Brushed chrome	1
FP8341FPB	Polished brass	1
FP8341FBB	Brushed brass	1
FP8341FGM	Gunmetal	1
FP8341FPL	Pearl	1

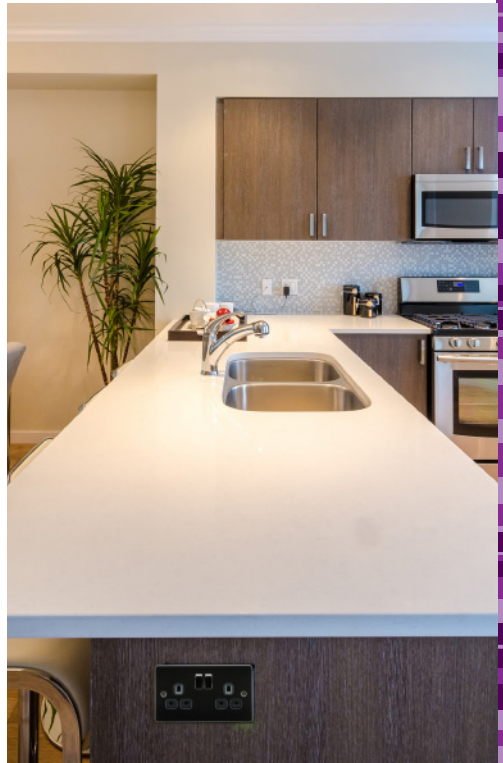

# FLAT PLATE: 45A SWITCHES AND SOCKETS

THE MINIMUM MOUNTING DEPTH FOR PRODUCTS ON THIS PAGE IS 47MM



## 45A 1G DP SWITCH WITH NEON

Minimum mounting depth 35mm.

Code	Finish	Qty
FP8331NPC	Polished chrome	1
FP8331NBC	Brushed chrome	1
FP8331NPB	Polished brass	1
FP8331NBB	Brushed brass	1
FP8331NGM	Gunmetal	1
FP8331NPL	Pearl	1



## 45A 2G DP SWITCH WITH NEON

Code	Finish	Qty
FP8332NPC	Polished chrome	1
FP8332NBC	Brushed chrome	1
FP8332NPB	Polished brass	1
FP8332NBB	Brushed brass	1
FP8332NGM	Gunmetal	1
FP8332NPL	Pearl	1



## 45A 2G DP SWITCH AND 13A DP SWITCHED SOCKET WITH NEONS - BLACK INSERT

Code	Finish	Qty
FP8333NPC	Polished chrome	1
FP8333NBC	Brushed chrome	1
FP8333NPB	Polished brass	1
FP8333NBB	Brushed brass	1
FP8333NGM	Gunmetal	1



## 45A 2G DP SWITCH AND 13A DP SWITCHED SOCKET WITH NEONS - WHITE INSERT

Code	Finish	Qty
FP8333NPCW	Polished chrome	1
FP8333NBCW	Brushed chrome	1
FP8333NPLW	Pearl	1

## FLAT PLATE: MEDIA

THE MINIMUM MOUNTING DEPTH FOR PRODUCTS ON THIS PAGE IS 25MM

Telephone - Screw terminal

Network - IDC terminal



### TELEPHONE MASTER SOCKET

Code	Finish	Qty
FP7300PC	Polished chrome	1
FP7300BC	Brushed chrome	1
FP7300PB	Polished brass	1
FP7300BB	Brushed brass	1
FP7300GM	Gunmetal	1
FP7300PL	Pearl	1



### 1G RJ45 IDC NETWORK OUTLET

Code	Finish	Qty
FPRJ45PC	Polished chrome	1
FPRJ45BC	Brushed chrome	1
FPRJ45PB	Polished brass	1
FPRJ45BB	Brushed brass	1
FPRJ45GM	Gunmetal	1
FPRJ45PL	Pearl	1

### TELEPHONE EXTENSION SOCKET

Code	Finish	Qty
FP7400PC	Polished chrome	1
FP7400BC	Brushed chrome	1
FP7400PB	Polished brass	1
FP7400BB	Brushed brass	1
FP7400GM	Gunmetal	1
FP7400PL	Pearl	1



## FLAT PLATE: MEDIA

THE MINIMUM MOUNTING DEPTH FOR PRODUCTS ON THIS PAGE IS 25MM



### 1G SAT/TV OUTLET (NON-ISOLATED)

Code	Finish	Qty
FP0150PC	Polished chrome	1
FP0150BC	Brushed chrome	1
FP0150PB	Polished brass	1
FP0150BB	Brushed brass	1
FP0150GM	Gunmetal	1
FP0150PL	Pearl	1



### 1G TV/FM DAB SCREENED DIPLEX OUTLET

Code	Finish	Qty
FP0160PC	Polished chrome	1
FP0160BC	Brushed chrome	1
FP0160PB	Polished brass	1
FP0160BB	Brushed brass	1
FP0160GM	Gunmetal	1
FP0160PL	Pearl	1



### 1G TV COAX OUTLET (NON-ISOLATED)

Code	Finish	Qty
FP0100PC	Polished chrome	1
FP0100BC	Brushed chrome	1
FP0100PB	Polished brass	1
FP0100BB	Brushed brass	1
FP0100GM	Gunmetal	1
FP0100PL	Pearl	1



### 1G SAT/TV OUTLET (ISOLATED)

Code	Finish	Qty
FP0140PC	Polished chrome	1
FP0140BC	Brushed chrome	1
FP0140PB	Polished brass	1
FP0140BB	Brushed brass	1
FP0140GM	Gunmetal	1
FP0140PL	Pearl	1





## FLAT PLATE: 115V/230V SHAVER SOCKETS

THE MINIMUM MOUNTING DEPTH FOR PRODUCTS ON THIS PAGE IS 47MM



### 115V/230V DUAL VOLTAGE SHAVER SOCKET BLACK INSERT

Code	Finish	Qty
FP8900PC	Polished chrome	1
FP8900BC	Brushed chrome	1
FP8900PB	Polished brass	1
FP8900BB	Brushed brass	1
FP8900GM	Gunmetal	1

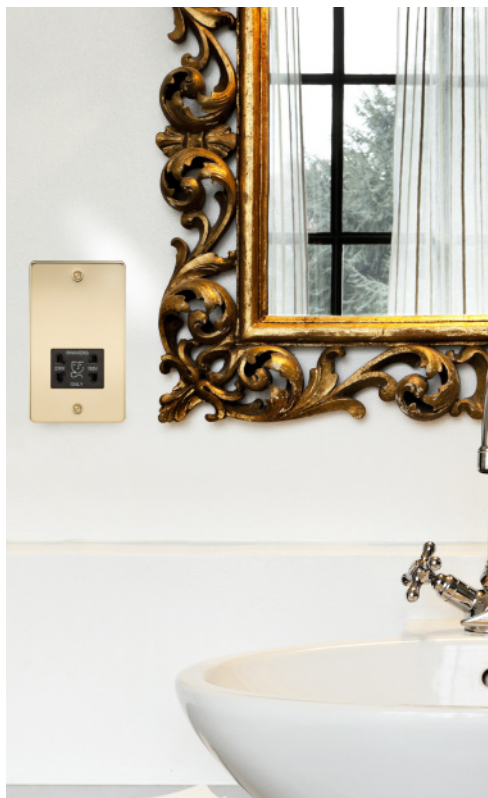

### 115V/230V DUAL VOLTAGE SHAVER SOCKET WHITE INSERT

Code	Finish	Qty
FP8900PCW	Polished chrome	1
FP8900BCW	Brushed chrome	1
FP8900PLW	Pearl	1

# FLAT PLATE: BLANKING PLATES



## 1G BLANKING PLATE

Code	Finish	Qty
FP8350PC	Polished chrome	1
FP8350BC	Brushed chrome	1
FP8350PB	Polished brass	1
FP8350BB	Brushed brass	1
FP8350GM	Gunmetal	1
FP8350PL	Pearl	1

## 2G BLANKING PLATE

Code	Finish	Qty
FP8360PC	Polished chrome	1
FP8360BC	Brushed chrome	1
FP8360PB	Polished brass	1
FP8360BB	Brushed brass	1
FP8360GM	Gunmetal	1
FP8360PL	Pearl	1

## FLAT PLATE: MODULAR FACEPLATES



### 1G MODULAR FACEPLATE

Code	Finish	Qty
FP1GPC	Polished chrome	1
FP1GBC	Brushed chrome	1
FP1GPB	Polished brass	1
FP1GBB	Brushed brass	1
FP1GGM	Gunmetal	1
FP1GPL	Pearl	1

### 2G MODULAR FACEPLATE

Code	Finish	Qty
FP2GPC	Polished chrome	1
FP2GBC	Brushed chrome	1
FP2GPB	Polished brass	1
FP2GBB	Brushed brass	1
FP2GGM	Gunmetal	1
FP2GPL	Pearl	1



### 4G MODULAR FACEPLATE

Code	Finish	Qty
FP4GPC	Polished chrome	1
FP4GBC	Brushed chrome	1
FP4GPB	Polished brass	1
FP4GBB	Brushed brass	1
FP4GGM	Gunmetal	1
FP4GPL	Pearl	1



\*MODULAR INSERTS AVAILABLE  
pages 70-72

# SPECIALIST SOCKETS: POP-UP SOCKETS



Code	Model	Qty
SK005	IP54 13A 2G POP UP SOCKET WITH DUAL USB CHARGER AND BLUETOOTH SPEAKER SYSTEM	1

Dual USB Charger ports 5V DC 2.1A (shared)  
2W RMS Bluetooth speaker system

**USB CHARGING**  
5V DC 2.1A



**Bluetooth**

**90MM**  
CUTTER SIZE

PAGE  
**102**

**\*Don't forget Holesaw for fitting**



**90MM**  
CUTTER SIZE



**USB CHARGING**  
5V DC 2.1A

**20MM**  
CUTTER SIZE

Code	Model	Qty
SK006	IP54 13A 3G SOCKET WITH DUAL USB CHARGER - UNDER CABINET/ WORKTOP MOUNTING	1

3 x 13A Sockets (no USB)

Code	Model	Qty
SK004	13A 2G POWER STATION WITH BUILT-IN SPEAKER AND USB CHARGER PORTS	1

Dual USB charger ports 5V DC 2.1A (shared)  
2W RMS speaker

# SPECIALIST SOCKETS: UNDER CABINET FITTINGS



Code	Model	Qty
SK007	13A 2G POWER STATION WITH DUAL USB CHARGER AND BLUETOOTH SPEAKER SYSTEM - UNDER CABINET MOUNTING	1

Dual USB charger ports 5V DC 2.1A (shared)  
2W RMS Bluetooth speaker system  
Includes tablet/book rest



Code	Model	Qty
------	-------	-----

SK001	13A 2G SOCKET WITH DUAL USB CHARGER - CORNER MOUNTING	1
-------	-------------------------------------------------------	---

Dual USB charger ports 5V DC 2.1A (shared)  
Includes universal mobile phone holder



Code	Model	Qty
------	-------	-----

SK003	13A 1G SOCKET WITH DUAL USB CHARGER - RECESS MOUNTING	1
-------	-------------------------------------------------------	---

Dual USB charger ports 5V DC 2.1A (shared)

Code	Model	Qty
------	-------	-----

SK002	13A 2G SOCKET WITH DUAL USB CHARGER - UNDER CABINET/WORKTOP MOUNTING	1
-------	----------------------------------------------------------------------	---

Dual USB charger ports 5V DC 2.1A (shared)



## Brilliant service,

staff are always very quick to respond to any problems or requests.

ML Accessories always go the extra mile with customer service and their products are without doubt at the

## cutting edge

of what's needed now and for tomorrow.

MLA are the "go to" company for any information regarding electrical goods. We always get an

## immediate response and first class customer service.

One of the **most efficient** companies I have worked with in over 20 years in the business



## ML Accessories are a class apart!

**Brilliant service and great communication.**

**A delightful company to work with.**

## ML Accessories are a fantastic company to deal with

on every level great people, great products and great service. Would highly recommend.

The staff are always polite with a happy manner and spot on technical knowledge, extremely helpful company with

Working with MLA is a breath of fresh air, nothing is too much trouble for them. They have an incredible and constantly growing range of products, their stock levels are exceptional and their

**service is second to none.**

If only all suppliers were this good.

## 10/10 service

**Section Index**

Sockets with USB	62
Sockets	63
Switches	64
Dimmers	65
45A Cooker Switches and Sockets	66
Fused Spurs	67
Media	68
Blanking Plates	68

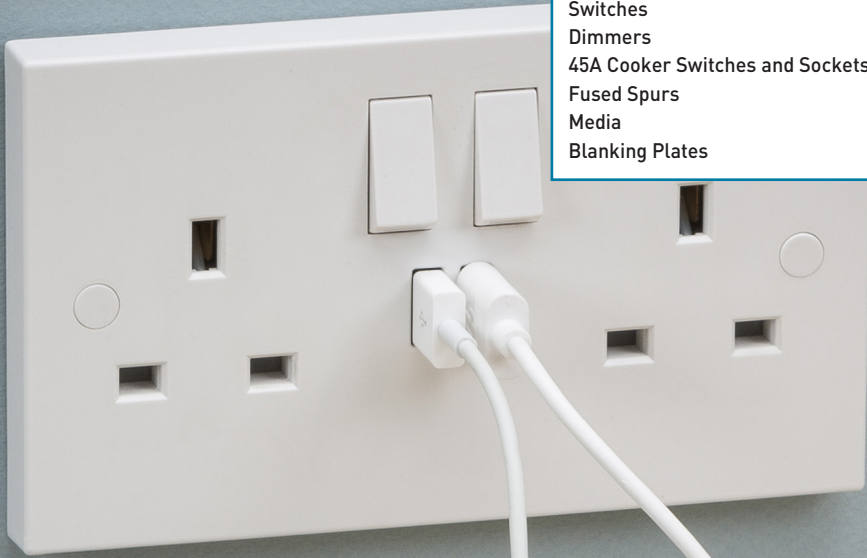

# STANDARD RANGE: SOCKETS WITH USB

## SOCKETS WITH USB CHARGING

The Knightsbridge Standard Range now offers upgraded USB charging rates suitable for charging multiple devices at the same time including smartphones and tablets 5.1A shared on our quad models, and up to 3.1A shared on our twin switched socket.



**13A 2G SWITCHED SOCKET WITH DUAL USB CHARGER SLOT 5V DC 3.1A (SHARED)**

Code	Finish	Qty
------	--------	-----



ST9904	White	5
--------	-------	---



**13A 1G SWITCHED SOCKET WITH USB CHARGER SLOT 5V DC 2A**

Code	Finish	Qty
ST9903	White	10



**1G QUAD USB CHARGER 5V DC 5.1A**

Code	Finish	Qty
STQUAD	White	1



**1G 13A SWITCHED SOCKET WITH QUAD USB CHARGER 5V DC 5.1A**

Code	Finish	Qty
ST7USB4	White	1



## STANDARD RANGE: SOCKETS

### STANDARD RANGE

Our core Standard Range offers exceptional quality and value.

- Constructed from durable, scratch resistant material
- Double pole (DP) switches (where stated)
- Comes complete with fixing screws and screw cap covers
- Compliant to the relevant British Safety Standards
- 12mm depth (unless otherwise stated)



### 13A 2G DP SWITCHED SOCKET

Code	Finish	Qty
ST9001	White	10
ST9002	White (9.5mm)	10



ST7000U



ST7000



ST9000U



ST5U



ST8900

### 13A 2G RCD PROTECTED SWITCHED SOCKET

- RCD trip current of 30mA
- RCD trip speed of  $\leq 40$ ms
- Latching type RCD – means unit does not need to be reset after a mains power failure
- Max operating load of 13A resistive, 3A inductive
- Dimensions: 146 x 86 x 14mm depth
- Retrofits into 25mm back box

### 13A 2G RCD PROTECTED SWITCHED SOCKET

Code	Finish	Qty
RCD9000	White	1



Code	Model	Qty
ST9000U	13A 2G Unswitched socket	10
ST9001	13A 2G DP Switched socket	10
ST9002	13A 2G DP Switched socket (9.5mm)	10
ST7000U	13A 1G Unswitched socket	10

Code	Model	Qty
ST7000	13A 1G DP Switched socket	10
ST5U	5A Unswitched round pin socket	10
ST8900	115V/230V Dual voltage shaver socket with neon	1

# STANDARD RANGE: SWITCHES



ST1200M

Standard Range 10A plate switches 9mm and 4mm have an interchangeable modular design. An intermediate module ST1200M can be purchased separately enabling an intermediate position to be placed on a 2G, 4G or 6G plate making them a versatile solution.



ST1000/ ST1200 / ST2000



ST3000



ST4000

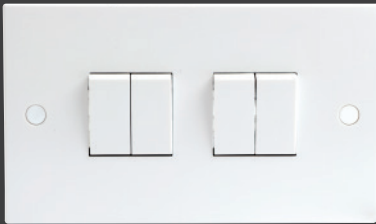

ST4100

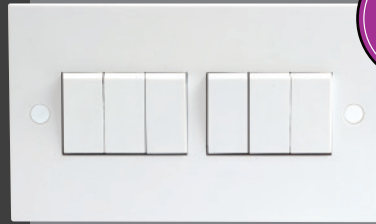

ST4200



ST1100



ST8341



ST8341N



SW127

Code	Model	Qty
ST1000	10A 1G 1 way plate switch	10
ST1100	10A 3 Pole fan isolator switch	10
ST1200	10A 1G Intermediate switch	10
ST1200M	10A Intermediate switch (module only)	1
ST2000	10A 1G 2 Way plate switch	10
ST3000	10A 2G 2 Way plate switch	10
ST4000	10A 3G 2 Way plate switch	10

Code	Model	Qty
ST4100	10A 4G 2 Way plate switch	10
ST4200	10A 6G 2 Way plate switch	10
SW127	10A 1G 2 Way architrave switch	20
ST8341	20A 1G DP Switch	10
ST8341N	20A 1G DP Switch with neon	10
ST8342	20A Flex outlet plate (centre or base flex exit)	10

## STANDARD RANGE: DIMMERS



ST2161 / ST2165 / W5420



ST2162



ST2163



ST2164



ST1DIM



ST2DIM



ST400M



VFR400M

### High quality leading edge dimmer switches

- Push on/push off operation
- Suitable for mains lighting, Low voltage and LED lighting
- Please check LED lamp compatibility with manufacturer
- Compliant to the relevant British Safety Standards

Code	Model	Qty
ST2161	1G 2 way 40-400W Dimmer	1
ST2162	2G 2 way 40-400W Dimmer	1
ST2163	3G 2 way 40-400W Dimmer	1
ST2164	4G 2 way 40-400W Dimmer	1
ST2165	1G 2 way 1000W Dimmer	1
ST400M	1G 2 way 40-400W Push dimmer module	1
VFR400M	1G 2 way 40-400W Push dimmer module, adjustable	10
W5420	1G 2 way 10-400W Trailing edge dimmer - optimised for LED	10
ST1DIM	1G Plate with dimmer knob*	10
ST2DIM	2G Plate with dimmer knobs*	10

\* For offset dimmer modules only

## STANDARD RANGE: 45A COOKER SWITCHES AND SOCKETS



ST8332

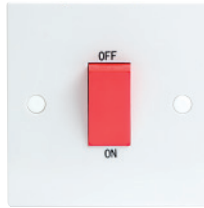

ST8331



ST8332N

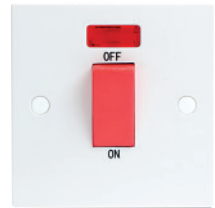

ST8331N

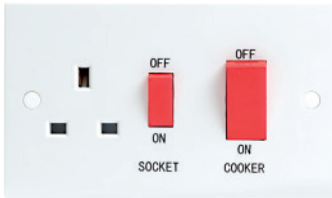

ST8333

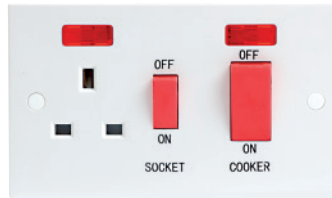

ST8333N



ST8340

### 45A series of cooker switches, sockets and connection units.

- Complete with twin earth lugs
- Double pole (DP) switches
- Clear on/off markings
- Complete with fixing screws and covers
- Fits into standard 47mm deep knock out box (1G - [SG147](#), 2G - [SG247](#))
- Fully compliant to relevant British Standards

Code	Model	Qty
ST8331	45A 1G DP Switch	10
ST8331N	45A 1G DP Switch with neon	10
ST8332	45A 2G DP Switch	10
ST8332N	45A 2G DP Switch with neon	10
ST8333	45A 2G DP Switch and 13A DP switched socket	10
ST8333N	45A 2G DP Switch and 13A DP switched socket with neon	10
ST8340	45A 1G Cooker cable connection unit	10



## STANDARD RANGE: FUSED SPURS



ST6000 / ST6000-3A

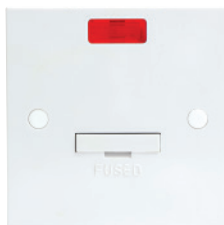

ST6000N



ST6300



ST6300N

The fused spur units come with an in-built fuse (and switch depending on model).

- Allows for flex cable entry from base
- Double pole (DP) switches
- Complete with fixing screws and covers
- Fully compliant to relevant British Standards
- British 1G faceplate size 86 x 86mm 12mm depth
- British 2G faceplate size 146 x 86mm 12mm depth

Code	Model	Qty
ST6000	13A Fused spur	10
ST6000-3A	3A Fused spur	10
ST6000N	13A Fused spur with neon	10
ST6300	13A Switched fused spur	10
ST6300N	13A Switched fused spur with neon	10



13A RCD Fused Spur units are ideal for use with equipment in utility rooms or washrooms i.e. hand dryers and are recommended for use with all underfloor heating installations up to a 13A loading.

- RCD trip speed of  $\leq 40$ ms
- Non-latching type RCD – means unit requires a reset after a mains power failure
- Max operating load of 13A resistive, 3A inductive
- Dimensions : 86 x 86 x 14mm
- Retrofits into 25mm back box

### 13A RCD FUSED SPUR

Code	Finish	Qty
RCD6000	White	1

RCD6000



## STANDARD RANGE: MEDIA SERIES AND BLANKING PLATES



7300



7400



ST0100



ST0140



ST8350

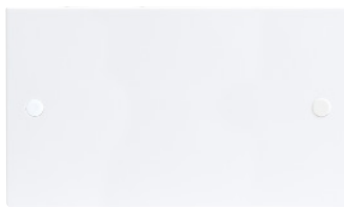

ST8360

**Essential media outlet plates. Ideal for TV, telecom and blanking requirements.**

- Isolated and non-isolated TV outlets
- Telephone outlets with IDC termination
- Complete with fixing screws and covers
- Fully compliant to relevant British Standards
- British 1G faceplate size 86 x 86mm 12mm depth
- British 2G faceplate size 146 x 86mm 12mm depth

Code	Model	Qty
7300	3/1A Flush mount master socket. IDC	10
7400	3/3A Flush mount extension socket. IDC	10
ST0100	TV Coax outlet (non-isolated)	10
ST0110	Twin TV coax outlet (non-isolated)	10
ST0120	TV Coax outlet (isolated)	10
ST0140	SAT/TV outlet (isolated)	10
ST8350	1G Blanking plate	10
ST8360	2G Blanking plate	10
ST9SPACER	2G 12mm spacer for use with 2G ST range	10



### Section Index

Modular Faceplates	70
Telecom Modules	70
Data Modules	70
Screened Modules	71
Modules Blanks	72
Kits and Cable Management	73
Patch Panels	74
UTP Network Cables	74
Datacomms Accessories	75
AV Series Cables and Connectors	76
USB Cables	77
Telephone Accessories	78



## DATACOMMS: MODULAR FACE PLATES



NET1GWH



NET2GWH

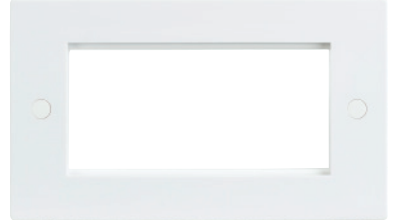

NET4GWH

### STANDARD MODULAR FACEPLATES

Code	Model	Qty
NET1GWH	1G Modular faceplate - white	10
NET2GWH	2G Modular faceplate - white	10

Code	Model	Qty
NET4GWH	4G Modular faceplate - white	10

## DATACOMMS: TELECOM MODULES



NETBTMWH

NETBTMBK



NETBTSWH

NETBTSBK



NETRJ11WH

NETRJ11BK

### TELEPHONE MODULES

Code	Model	Qty
NETBTMBK	Modular telephone master outlet - black	1
NETBTMWH	Modular telephone master outlet - white	1
NETBTSBK	Modular telephone slave outlet - black	1

Code	Model	Qty
NETBTSWH	Modular telephone slave outlet - white	1
NETRJ11BK	Modular RJ11 outlet - black	1
NETRJ11WH	Modular RJ11 outlet - white	1

## DATACOMMS: DATA MODULES

NETCAT5WH



NETCAT5BK

NETCAT6WH



NETCAT6BK

### DATA MODULES

Code	Model	Qty
NETCAT5WH	Modular UTP CAT5e RJ45 outlet - white	1
NETCAT5BK	Modular UTP CAT5e RJ45 outlet - black	1
NETCAT6WH	Modular UTP CAT6 RJ45 outlet - white	1
NETCAT6BK	Modular UTP CAT6 RJ45 outlet - black	1



# DATAComMS: SCREENED MODULES



\*SCREWLESS, FLAT PLATE AND METAL CLAD MODULAR FACEPLATE AVAILABLE, SEE PAGE 19, PAGE 39 AND PAGE 93

**NETTVSWH**

**NETSATSWH**

**NETDISATWH**



**NETTVSBK**



**NETSATSBK**



**NETDISATBK**

**NETDITVWH**

**NETTRIWH**

**NETQDWH**



**NETDITVBK**



**NETTRIBK**



**NETQDBK**

## SCREENED MODULES

Code	Model	Qty
<b>NETTVSBK</b>	Modular screened TV outlet - black	1
<b>NETTVSWH</b>	Modular screened TV outlet - white	1
<b>NETSATSBK</b>	Modular screened SAT TV outlet - black	1
<b>NETSATSWH</b>	Modular screened SAT TV outlet - white	1
<b>NETDISATBK</b>	Modular diplexed TV/SAT TV outlet black	1
<b>NETDISATWH</b>	Modular diplexed TV/SAT TV outlet white	1
<b>NETDITVBK</b>	Modular diplexed TV/FM DAB outlet - black	1

Code	Model	Qty
<b>NETDITVWH</b>	Modular diplexed TV/FM DAB outlet - white	1
<b>NETTRIBK</b>	Modular triplexed TV/FM DAB/ SAT TV outlet - black	1
<b>NETTRIWH</b>	Modular triplexed TV/FM DAB/ SAT TV outlet white	1
<b>NETQDBK</b>	Modular quadplexed SAT1/SAT2/TV/FM DAB outlet - black	1
<b>NETQDWH</b>	Modular quadplexed SAT1/SAT2/TV/FM dab outlet - white	1

# DATACOMMS: MODULES AND BLANKING PLATES



## TV AND SAT MODULES

Code	Model
<b>NETSATBK</b>	Modular SAT TV outlet - black
<b>NETSATWH</b>	Modular SAT TV outlet - white
<b>NETTVBK</b>	Modular TV outlet (PCB) - black
<b>NETTVWH</b>	Modular TV outlet (PCB) - white

NETSATWH    NETSATBK    NETSATWH    NETSATBK



NETHDMIBK    NETHDMIWH

## HDMI MODULES

Code	Model	Qty
<b>NETHDMIBK</b>	Modular HDMI outlet - black	1
<b>NETHDMIWH</b>	Modular HDMI outlet - white	1



NETUSBWH    NETUSBBK

## USB CHARGING MODULES

Code	Model	Qty
<b>NETUSBBK</b>	Modular dual USB charger 5V DC 2A - black	1
<b>NETUSBWH</b>	Modular dual USB charger 5V DC 2A- white	1



NET13WH    NET13BK

## POWER OUTLET MODULES

Code	Model	Qty
<b>NET13WH</b>	13A unswitched socket module - white	1
<b>NET13BK</b>	13A unswitched socket module - black	1



NETHWH    NETHBK    NETQWH    NETQBK

## MODULAR BLANKING PLATES

Code	Model	Qty
<b>NETHWH</b>	Pack of 10 modular half blanking plates - white	1
<b>NETHBK</b>	Pack of 10 modular half blanking plates - black	1
<b>NETQWH</b>	Pack of 10 modular quarter blanking plates - white	1
<b>NETQBK</b>	Pack of 10 modular quarter blanking plates - black	1



**NETBRUSH2G**



**NETBRUSH4G**



**SX7210BK**

## BRUSH OUTLETS AND MODULES

Code	Model	Qty
<b>NETBRUSH2G</b>	2G letterbox style faceplate	1
<b>NETBRUSH4G</b>	4G letterbox style faceplate	1
<b>SX7210BK</b>	Brush module 25 x 50mm	1

Code	Model	Qty
<b>SX7206BK</b>	Brush module 50 x 50mm	1
<b>SX7208BK</b>	Brush module 50 x 100mm	1



**SX7051WH**



**SX7052WH**



**NET6KIT1**



**NET6KIT2**

## CAT5E OUTLET KITS

Code	Model	Qty
<b>SX7051WH</b>	Single CAT5e outlet kit	1
<b>SX7052WH</b>	Twin CAT5e outlet kit	1

## CAT6E OUTLET KITS

Code	Model	Qty
<b>NET6KIT1</b>	Single CAT6 outlet kit	1
<b>NET6KIT2</b>	Twin CAT6 outlet kit	1

## DATACOMMS: PATCH PANELS

PPC24



PPC24CAT6



PPC48



PPC48CAT6



Patch panels available in 24 and 48 port configuration in either UTP CAT5e and CAT6 options:

- IDC type connectors, 568A/568B wiring
- CAT6 models come with rear cable management

### PATCH PANELS

Code	Model	Qty
PPC24	1U 24 port 19" CAT5E RJ45 patch panel	1
PPC48	2U 48 port 19" CAT5E RJ45 patch panel	1

Code	Model	Qty
PPC24CAT6	1U 24 port 19" CAT6 RJ45 patch panel	1
PPC48CAT6	2U 48 port 19" CAT6 RJ45 patch panel	1

## DATACOMMS: UTP NETWORK CABLES

NETC51M



NETC61M

The most popular of the twisted pair cables in use today. CAT5e compliant, supporting speeds of up to 100Mbps and gigabit speeds of up to 1000Mbps. RJ45 plug to plug configuration, over-moulded connectors with strain reliefs to ensure minimal bend radius, along with snag free boots to prevent damage to connector.

The latest generation of Gigabit Ethernet technology. Supporting speeds of 100/1000Mbps same as CAT5e but also the latest 10GbE standards. RJ45 plug to plug configuration, over-moulded connectors with strain reliefs to ensure minimal bend radius along with snag free boots to prevent damage to connector.

### CAT5E NETWORKING CABLES

Code	Length	Colour	Qty
NETC51M	1m	grey	1
NETC53M	3m	grey	1
NETC55M	5m	grey	1
NETC510M	10m	grey	1

### CAT6 NETWORKING CABLES

Code	Length	Colour	Qty
NETC61M	1m	black	1
NETC63M	3m	black	1
NETC65M	5m	black	1
NETC610M	10m	black	1



**SM314**



**SM315**



**NETC5CP**



**NETC6CP**



**BK4503**



**BK4505**



**XT468**



**XT500BX**



**XT901BX**



**LJ5002**



**LJ5207BP**

## CONNECTOR AND JUNCTION BOXES

Code	Model	Qty
<b>SM314</b>	CAT5e black junction box	1
<b>SM315</b>	CAT6 black junction box	1
<b>NETC5CP</b>	UTP CAT5e RJ45 coupler	1
<b>NETC6CP</b>	UTP CAT6 RJ45 coupler	1
<b>BK4503</b>	Secondary line adaptor	1
<b>BK4505</b>	Master line adaptor	1
<b>XT468</b>	Remote network cable tester for RJ45 and RJ11	1

## NETWORKING TOOLS

Code	Model	Qty
<b>XT500BX</b>	Remote cable tester for RJ45/RJ11/USB and BNC	1
<b>XT901BX</b>	LAN installation tool kit	1
<b>LJ5002</b>	Professional punch down tool - IDC 1	1
<b>LJ5207BP</b>	4 in 1 cable stripper for datacomms and coaxial cable	1

# DATACOMMS: AV CABLES



**HDMI**  
HIGH SPEED  
with ETHERNET

AV8

AV1

AV3

## AV-SERIES

### TV AND SAT TV CABLE

**Features:** Quality RG6 (AV3) and RG59U (AV1) cable construction for optimum signal reception. Handy adaptors and couplers included where relevant

Code	Model	Qty
AV1	2m TV coax cable with coupler	10
AV3	2m SAT TV cable with adaptors	10

### HIGH SPEED HDMI CABLE WITH ETHERNET

**Features:** Full 1080P. HDMI and HDCP compliant supports audio return channel (ARC) and 3D over HDMI. Gold plated connectors for optimum connectivity. Durable over-moulded connectors and nylon braided cable for longevity. Supplied in attractive clam shell packaging or full colour box

Code	Model	Qty
AV2	2m High Speed HDMI cable with ethernet	10
AV6	5m High Speed HDMI cable with ethernet	1
AV7	10m High Speed HDMI cable with ethernet	1
AV8	3m High Speed HDMI cabling kit *	1

\*[AV8] includes a HDMI to mini HDMI and micro HDMI adaptor.

## DATACOMMS: USB CABLES



AV4



AV5

### USB CABLES

**Features:** Compliant with high speed USB2.0 specification. Durable over-moulded connectors with hard wearing nickel plated contacts. Supplied in attractive clam shell packaging

Code	Model	Qty
AV4	2m USB2.0 micro USB cable	10
AV5	2m USB2.0 A-B cable	10



Complete range in full colour retail packaging

**AV-SERIES**

# DATACOMMS: TELEPHONE ACCESSORIES

## TELEPHONE EXTENSION CABLES

- Extension cables are ideal for providing short or medium length extensions to existing telephone sockets

Code	Model	Length	Qty
LJ005	Telephone extension cable	5m	1
LJ006	Telephone extension cable	10m	1
LJ001	DIY extension kit	20m	1



NTE5A master socket (**LJ0013**) represents the official demarcation point between the domestic wiring (home owner responsibility) and the external telephone line (provider's responsibility). They are crucial in identifying faults and allocating responsibility for their rectification.

Plug-in broadband filter (**LJ0012**) plugs into modern master sockets providing ADSL and filtered telephone outlet on one faceplate. The equivalent to BT NTE2000. Microfilters are fully compatible with ADSL/MaxDSL/ADSL2/ADSL2+ and manufactured to exceed the BT SIN 346 guidelines.



LJ010

LJ009

LJ0012

LJ0013

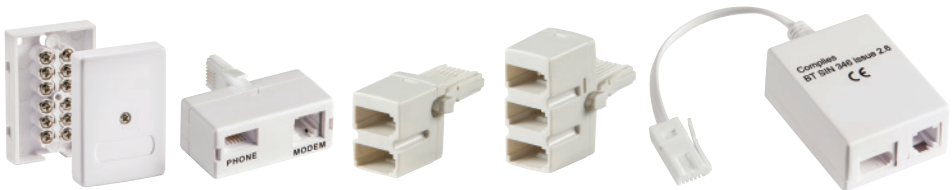

LJ0011

LJ009

LJ007

LJ008

LJ0010

## TELEPHONE SOCKETS AND ADAPTORS

Code	Model	Qty
7100	2/1A surface mount master - IDC	10
7200	2/3A surface mount ext - IDC	10
7300	3/1A flush mount master - IDC	10
7400	3/3A flush mount ext - IDC	10

Code	Model	Qty
LJ007	Telephone double adaptor	1
LJ008	Telephone triple adaptor	1
LJ009	ADSL splitter	1
LJ0010	ADSL microfilter	1
LJ0011	6 way telephone junction box	1
LJ0012	VDSL2 plug-in broadband filter	1
LJ0013	NTE5A master socket	1



**Section Index**

Pattress Boxes	80
Dry Lining Boxes	81
Galvanised Steel Back Boxes	82
Pull Cord Switches	83
Batten Holders	84
Ceiling Rose and Pendant Sets	84
Junction Boxes	85
Night Lights	86
Towers and Extension Leads	87
Plug Tops and Sockets	88-89



# PATRESS BOXES



ST1300



ST1400



ST1700



ST1610



ST1500



ST1800



ST1600



ST1510

A range of pattress boxes enabling surface mounting of sockets and switches.

- Made from thermoset resin
- With knock-outs on sides and base for cable entry
- Fitted with an earth terminal where stated
- Compliant to all relevant British Standards

## PATRESS BOXES

Code	Model	Qty
ST1300	16mm single pattress box with earth terminal	10
ST1400	25mm single pattress box	10
ST1500	25mm double pattress box	10
ST1510	25mm twin pattress box with earth terminal	10
ST1600	47mm double pattress box with earth terminal	10
ST1610	47mm single pattress box with earth terminal	10
ST1700	35mm single pattress box with earth terminal	10
ST1800	35mm double pattress box with earth terminal	10





**8370**



**8381**



**8380**



**8382**



**8335D**



**8380D**



**8375**

A dry lining box range offering a diverse selection for a variety of installation requirements.

- Adjustable for varying plasterboard thickness
- Large flange to prevent slipping into cavity
- Complete with knock-outs
- Compliant to all relevant British Standards

**DRY LINING BOXES**

Code	Model	Qty
<b>8370</b>	35mm 1G dry lining box	10
<b>8375</b>	34mm round dry lining box	10
<b>8380</b>	35mm 2G dry lining box	10
<b>8381</b>	47mm 1G dry lining box	10
<b>8382</b>	47mm 2G dry lining box	10
<b>8335D</b>	35mm 1G + 2G dry lining box	10
<b>8380D</b>	35mm dual dry lining box	10



# GALVANISED STEEL BACK BOXES AND EXTENSION BOXES

## An extensive range of galvanised steel back boxes

- Adjustable lugs
- Fitted with earth terminal as standard
- 20mm knock-outs on all sides (except EG116)
- 20mm and 25mm knock-outs on 35mm and 45mm boxes
- Compliant to all relevant British Standards



## GALVANISED STEEL BACK BOXES

Code	Model	Qty
SG116	16mm 1G galvanised steel box	10
SG127	28mm architrave galvanised steel box	20
SG125	25mm 1G galvanised steel box	10
SG135	35mm 1G galvanised steel box	10
SG147	47mm 1G galvanised steel box	10
SG225	25mm 2G galvanised steel box	10
SG235	35mm 2G galvanised steel box	10
SG247	47mm 2G galvanised steel box	10
SG235D	35mm dual galvanised steel box	10
SG335	35mm 3G galvanised steel box	10
SG335D	35mm 1G + 2G galvanised steel box	10

## EXTENSION BOXES

Code	Model	Qty
EG116	16mm 1G galvanised steel extension box 20	
EG125	25mm 1G galvanised steel extension box 10	
EG135	35mm 1G galvanised steel extension box 10	
EG225	25mm 2G galvanised steel extension box 5	
EG235	35mm 2G galvanised steel extension box 5	

8300DIM



## PULL CORD SWITCHES

Code	Model	Qty
8290	6A 1 way pull cord switch	10
8300	6A 2 way pull cord switch	1
ST8310N	45A DP pull cord switch with neon	1
8300BC	10A 2 way pull cord switch - brushed chrome	1
8300PC	10A 2 way pull cord switch- polished chrome	1
8300DIM	50-250W dimmable pull cord switch	1

8290 / 8300



ST8310N



8300PC



8300BC



8300DIM

## BATTEN HOLDERS



8200



8210



8220



8230



8250

### BATTEN HOLDERS

Code	Model	Qty
8200	T2 HO BC batten holder	10
8210	T2 straight/short skirt BC batten holder	10
8220	T2 angled HO BC batten holder	10
8230	T2 HO BC batten holder ceiling rose base	10
8250	T2 BC cord grip lampholder	10

## CEILING ROSE AND PENDANT SETS



8270/8280



8260

### CEILING ROSE AND PENDANT SETS

Code	Model	Qty
8260	Ceiling rose	10
8261	6" 18W low energy pendant set	1
8270	6" T2 BC pendant set	10
8280	9" T2 BC pendant set	1

# JUNCTION BOXES



## JUNCTION BOXES

Code	Model	Qty
8400	5A junction box 4 terminal white	10
8400B	5A junction box 4 terminal brown	10
8410	20A junction box 4 terminal white	10
8410B	20A junction box 4 terminal brown	10
8420	20A junction box 4 terminal white [2-1/4dia]	10
8420B	20A junction box 4 terminal brown [2-1/4dia]	10
8430	30A junction box 3 terminal white	10
8430B	30A junction box 3 terminal brown	10
8460	20A junction box 6 terminal white	10
8460B	20A junction box 6 terminal brown	5
8470	60A junction box 3 terminal white 25.0mm	5
8470B	60A junction box 3 terminal brown 25.0mm	5

## INLINE SWITCH

Code	Model	Qty
1250	6A DP inline lamp switch	20

## IP44 JUNCTION BOX

Code	Model	Qty
JB001	IP44 16A 3 pole junction box	1

## EARTHING BLOCKS

Code	Model	Qty
EB1	100A 5 way connector block SP (35mm)	10
EB2	100A 2 x 5 way connector block DP (35mm)	5

# NIGHT LIGHTS

## NIGHT LIGHTS

Code	Finish	Qty
NL001	Plug in LED night light	1
NL002	Plug in LED night light with dual USB charger ports 5V DC 2.1A	1



NL001



NL002





## TOWERS AND EXTENSION LEADS

### SURGE PROTECTED TOWERS

Code	Model	Cable length	Qty
8GTOWER	13A 8G tower	2m	1
10GTOWER	13A 10G tower	2m	1
12GTOWER	13A 12G tower	2m	1



### SURGE PROTECTED EXTENSION LEADS

Code	Model	Cable length	Qty
2004S2M	13A 4G extension lead	2m	1
2006S2M	13A 6G extension lead	2m	1



### EXTENSION LEADS

Code	Model	Cable length	Qty
20042M	13A 4G extension lead	2m	1
20043M	13A 4G extension lead	3m	1
20062M	13A 6G extension lead	2m	1



# PLUG TOPS, SOCKETS AND CONNECTORS



2121W



2135-RB



2013B



2014B

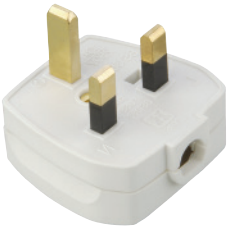

2135-RW

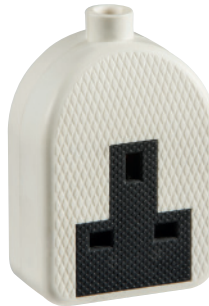

2013W



2014W

Code	Model	Qty
2135-RB	13A rough use plug top 13A fused clamp type cord grip - black	20
2135-RW	13A rough use plug top 13A fused clamp type cord grip - white	20
2013B	13A 1G trailing socket black	10

Code	Model	Qty
2013W	13A 1G trailing socket white	10
2014B	13A 2G trailing socket black	10
2014W	13A 2G trailing socket white	10
2121B	10A 3 pin cable connector - black	10
2121W	10A 3 pin cable connector - white	10

## PLUG TOPS AND SOCKETS



RCD002



1383



135A

Code	Model	Qty
RCD002	RCD safety plug	1
1381	13A plug top with 5A fuse - White	20
1382	13A plug top with 3A fuse - White	20
1383	13A plug top with 13A fuse - White	20

Code	Model	Qty
1383-BK	13A plug top with 13A fuse - Black	20
135A	5A round pin plug top - White	20
1315A	15A round pin plug top - White	20
132A	2A round pin plug top - White	20



Code	Model	Qty
RCD001	13A RCD Safety adaptor	1

The RCD Safety adaptor is a plug through device. Suitable for use with any 240V electric appliance that has a UK Plug top. It's specifically recommended for use whenever you use an electric power tool or gardening equipment such as a lawnmower.

- Non-latching type RCD – meaning it requires resetting should there be a mains power failure. This ensures protection to anyone using a device at the time, should the power suddenly come back on again.
- Compliant to all relevant safety standards.



1350



1375



8910

Code	Model	Qty
1350	13A 2 way mains adaptor (unfused)	10
1375	13A 3 way mains adaptor (fused)	10
8910	Shaver adaptor - fused	20

# WEATHERPROOF: SWITCHES AND SOCKETS



Code	Model	Qty
<b>IP9000R</b>	IP66 13A 2G remote controlled socket	1
<b>IPRCD</b>	IP66 13A RCD 2G switched socket	1
<b>IP9000</b>	IP66 13A 2G DP switched socket	1

Code	Model	Qty
<b>IP3000</b>	IP66 10A 2G 2 way switch	1
<b>IP7000</b>	IP66 13A 1G DP switched socket	1
<b>IP2000</b>	IP66 10A 1G 2 way switch	1



**20m**  
RANGE



Code	Model	Qty
<b>IP7000R</b>	IP66 13A 1G remote controlled socket	1

Code	Model	Qty
<b>IP7000D</b>	IP66 13A 7 day digital timer socket	1



Code	Model	Qty
IP3G	IP66 13A 3G switch box	1
IP5G	IP66 13A 5G switch box	1

REMOTE CONTROLLED SWITCH BOXES

20m RANGE



Code	Model	Qty
IP663G	IP66 3G remote controlled switch box	1
IP665G	IP66 5G remote controlled switch box	1



# WEATHERPROOF: 13A FUSED SPURS, JUNCTION BOXES AND ACCESSORIES



Code	Model	Qty
IP6000	IP66 13A fused spur unit	1
IP6300	IP66 13A switched fused spur unit	1



Code	Model	Qty
JB005	IP66 30A junction box	1
JB007	IP66 junction box (small) 86mm x 74mm x 62mm	1
JB008	IP66 junction box (medium) 125mm x 86mm x 62mm	1
JB009	IP66 junction box (large) 181mm x 111mm x 100mm	1
JB0010	IP66 junction box (x-large) 274mm x 184mm x 135mm	1
IP68JBS	IP68 16A 48V junction box for series wiring	1



Code	Model	Qty
JB006	IP66 20mm cable glands	10
JB002	IP68 16A weatherproof inline connector (3 pole)	1

Code	Model	Qty
JB003	IP68 16A 3-way cable connector (3 pole)	1
JB004	IP68 16A waterproof connector box	1

**Section Index**

13A Sockets	94-95
Switches and Dimmers	96
13A Fused Spurs and 20A Switches	97
45A Switches/Sockets with Neon	97
Telephone and Data Sockets	98
Blanking Plates	98
Modular Faceplates	98



P94

## METAL CLAD: SOCKETS



### 13A SOCKETS

Code	Model	Qty
M9000	13A 2G DP switched socket	5

Knightsbridge® metal clad series has a rugged design with a tough, durable, powder-coated finish. Supplied complete with back box unless otherwise stated. All models have multiple 20mm cable gland entry from all sides. They are designed for use in areas where standard plastic or thermoset resin sockets/switches could potentially be exposed to damage within industrial environments, workshops or domestic garages. Compliant to all relevant British Standards



## METAL CLAD: 13A SOCKETS



### 13A SWITCHED SOCKETS WITH USB CHARGER

Heavy duty metal clad box. 13A switched sockets with the added convenience of USB charging. Suitable for charging various USB devices including mobile phones, smartphones, digital cameras and tablets. 5V DC 2.1A.

Code	Model	Qty
<b>MC7000USB</b>	13A 1G switched socket with dual USB charging	1
<b>MC9000USB</b>	13A 2G switched socket with dual USB charging	1



**M7000**



**M9000**



**M7000U**



### 13A SOCKETS

Code	Model	Qty
<b>M7000</b>	13A 1G DP switched socket	10
<b>M7000U</b>	13A 1G unswitched socket	10
<b>M9000</b>	13A 2G DP switched socket	5
<b>M9000U</b>	13A 2G unswitched socket	5



**M9000U**

All models have multiple 20mm cable gland entry from all sides.



M1200 / M2000



M3000



M4000



M4100



M4200



M1100

### 10A SWITCHES

Code	Model	Qty
M1200	10A 1G intermediate switch	1
M2000	10A 1G 2 way switch	10
M3000	10A 2G 2 way switch	10
M4000	10A 3G 2 way switch	10
M4100	10A 4G 2 way switch	1
M4200	10A 6G 2 way switch	1
M1100	10A fan isolator switch	1



M2161



M2162

### 60-400W DIMMERS

Code	Model	Qty
M2161	1G 2 way 60-400W dimmer	1
M2162	2G 2 way 60-400W dimmer	1

## METAL CLAD: 13A FUSED SPURS AND 20A SWITCHES



M6000



M6000N



M6300



M6300N



M6300F



M8341



M8341N



M8341WH

Code	Model	Qty
M6000	13A unswitched fused spur	10
M6000N	13A unswitched fused spur with neon	10
M6300	13A switched fused spur	10
M6300N	13A switched fused spur with neon	10
M6300F	13A switched fused spur with front flex outlet	10
M8341	20A 1G DP switch	10
M8341N	20A 1G DP switch with neon	10
M8341WH	20A 1G DP switch with neon, flex outlet and marked "water heater"	1

All models have multiple 20mm cable gland entry from all sides.

## METAL CLAD: 45A SWITCHES / SOCKETS WITH NEON



M8332N



M8331N



M8333N

Code	Model	Qty
M8331N	45A 1G DP switch with neon - small plate	1
M8332N	45A DP switch with neon - large plate	1
M8333N	45A 2G DP switch & 13A switched socket with neons	1

## METAL CLAD: TELEPHONE AND DATA SOCKETS



M7300



MRJ45

### MEDIA

Code	Model	Qty
M7300	Telephone master socket	1
M7400	Telephone extension socket	1
MRJ45	RJ45 network outlet	1



## METAL CLAD: BLANKING PLATES



M8700

M8500



M8900

M8600

Code	Model	Qty
M8700	Single back box	10
M8500	Single blanking plate	10

Code	Model	Qty
M8900	Double back box	5
M8600	Double blanking plate	10

All models have multiple 20mm cable gland entry from all sides.

## METAL CLAD: MODULAR FACEPLATES



Code	Model	Qty
M1G	Metal clad 1G modular faceplate	1
M2G	Metal clad 2G modular faceplate	1



Code	Model	Qty
M4G	Metal clad 4G modular faceplate	1

# INDUSTRIAL ACCESSORIES: PLUGS, SOCKETS AND CONNECTORS



- EN 60947 compliant
- Modern rotary switch technology
- 4 x M20/M25 knockouts
- Interlocking lid ensures removal in OFF position only
- Handle can be padlocked for safety (padlock not included)

## IP65 ROTARY ISOLATORS

Code	Model	Qty
IN0025	20A rotary isolator 4P AC	1
IN0026	32A rotary isolator 4P AC	1
IN0027	63A rotary isolator 4P AC	1

The Knightsbridge® range of industrial plugs, sockets and connectors are best suited for applications where power requirements can change from day to day, including building sites and other temporary locations. The two part plugs, connectors and angled sockets are robust and easy to use.



## IP44 110V INDUSTRIAL PLUGS, SOCKETS AND CONNECTORS

- Earth contact position: 4h

Code	Model	Qty
IN001	110V 16A plug 2P +E	10
IN002	110V 16A connector 2P +E	10
IN003	110V 16A angled surface mount socket 2P +E	10
IN004	110V 16A angled panel mount socket 2P +E	10
IN005	110V 16A 3 way splitter 2P +E	5



# INDUSTRIAL ACCESSORIES: PLUGS, SOCKETS AND CONNECTORS



## IP44 240V INDUSTRIAL PLUGS, SOCKETS AND CONNECTORS

- Earth contact position: 6h

Code	Model	Qty
IN006	240V 16A plug 2P+E	10
IN007	240V 16A connector 2P+E	10
IN008	240V 16A angled surface mount socket 2P+E	10
IN009	240V 16A angled panel mount socket 2P+E	20
IN0010	240V 16A 3 way splitter 2P+E	5

Code	Model	Qty
IN0021	240V 16A appliance inlet 2P+E	1
IN0022	240V 32A appliance inlet 2P+E	1
IN0011	240V 32A plug 2P+E	10
IN0012	240V 32A angled surface mount socket 2P+E	10
IN0013	240V 32A angled panel mount socket 2P+E	10



## IP44 415V INDUSTRIAL PLUGS, SOCKETS AND CONNECTORS

- Earth contact position: 4h

Code	Model	Qty
IN0014	415V 16A plug 3P+N+E	10
IN0015	415V 16A connector 3P+N+E	10
IN0016	415V 32A plug 3P+N+E	10
IN0017	415V 16A angled panel mount socket 3P+N+E	10
IN0018	415V 32A angled panel mount socket 3P+N+E	10
IN0019	415V 16A angled surface mount socket 3P+N+E	10
IN0020	415V 32A angled surface mount socket 3P+N+E	10



## TOOLS: HOLESAWS AND ACCESSORIES



**HS25MM**



**HS38MM**



**HS72MM**



**HSARBORL**



**HSARBORS**

### HOLESAWS

Code	Model	Qty
<b>HS20MM</b>	20mm Bi-Metal Holesaw	1
<b>HS25MM</b>	25mm Bi-Metal Holesaw	1
<b>HS32MM</b>	32mm Bi-Metal Holesaw	1
<b>HS38MM</b>	38mm Bi-Metal Holesaw	1
<b>HS51MM</b>	51mm Bi-Metal Holesaw	1
<b>HS60MM</b>	60mm Bi-Metal Holesaw	1
<b>HS65MM</b>	65mm Bi-Metal Holesaw	1
<b>HS70MM</b>	70mm Bi-Metal Holesaw	1
<b>HS72MM</b>	72mm Bi-Metal Holesaw	1
<b>HS75MM</b>	75mm Bi-Metal Holesaw	1
<b>HS80MM</b>	80mm Bi-Metal Holesaw	1
<b>HS85MM</b>	85mm Bi-Metal Holesaw	1
<b>HS90MM</b>	90mm Bi-Metal Holesaw	1

### HOLESAW ACCESSORIES

Code	Model	Qty
<b>HSARBORL</b>	A2 Size Arbor with Pilot Drill Bit	1
<b>HSARBORS</b>	A4 Size Arbor with Pilot Drill Bit	1
<b>HSPILOTDDB5</b>	Pack of 5 Arbor Pilot Drill Bits 6.35mm x 75mm	1



**HSPILOTDDB5**





# TEST EQUIPMENT: VOLTAGE DETECTION



## IP64 CAT III 2 POLE TESTER WITH LED & LCD DISPLAY

Code	Model	Qty
TE1	IP64 CAT III 2 pole tester with LED & LCD display Self proving function with handy built-in LED torch function	1



## IP64 CAT III 2 POLE TESTER WITH LED DISPLAY

Code	Model	Qty
TE2	IP64 CAT III 2 pole tester with LED display Self proving function with handy built-in LED torch function	1



## BS1363 SOCKET TESTER

Code	Model	Qty
TE3	CAT II BS1363 socket tester Easy to use with clear fault diagnosis	1



## CAT IV NON CONTACT VOLTAGE DETECTOR

Code	Model	Qty
TE4	CAT IV Non contact voltage detector Easy to use with audible and visual notification in presence of voltage	1



# TEST EQUIPMENT: DIGITAL MULTIMETERS

10A CAT III 600V TRUE RMS  
DIGITAL MULTIMETER WITH NCV

Code	Model	Qty
TE6	10A CAT III 600V True RMS digital multimeter with NCV With temperature function	1



## DIGITAL MULTIMETER

## DIGITAL CLAMP METER



Mechanical blocking system



20A CAT III 1000V TRUE RMS  
DIGITAL MULTIMETER WITH NCV

Code	Model	Qty
TE7	20A CAT III 1000V True RMS digital multimeter with NCV With temperature function	1



45mm jaw calibre



1000A CAT III DIGITAL CLAMP  
METER WITH DUAL DISPLAY

Code	Model	Qty
TE8	1000A CAT III digital clamp meter with dual display With temperature function	1

# TEST EQUIPMENT: ENVIRONMENTAL METERS



## LASER DISTANCE METER (60M)

Code	Model	Qty
TE13	Laser distance meter (60m) Fully featured laser distance meter	1



## DIGITAL LUX METER

Code	Model	Qty
TE5	Digital lux meter Ideal for surveying or testing lighting installations and set ups	1



## INFRARED THERMOMETER GUN

Code	Model	Qty
TE10	Infrared thermometer gun Spot ratio of 10:1	1



## POCKET INFRARED THERMOMETER

Code	Model	Qty
TE11	Pocket infrared thermometer Spot ratio of 6:1	1



## MINI TEMPERATURE METER

Code	Model	Qty
TE15	Mini temperature meter Hand held complete with probes.	1



## DIGITAL MOISTURE METER

Code	Model	Qty
TE14	Digital moisture meter Ideal for testing moisture levels in sawn timber, paper, cardboard and hardened materials like mortar or plaster	1



# VENTILATION: EXTRACTOR FANS

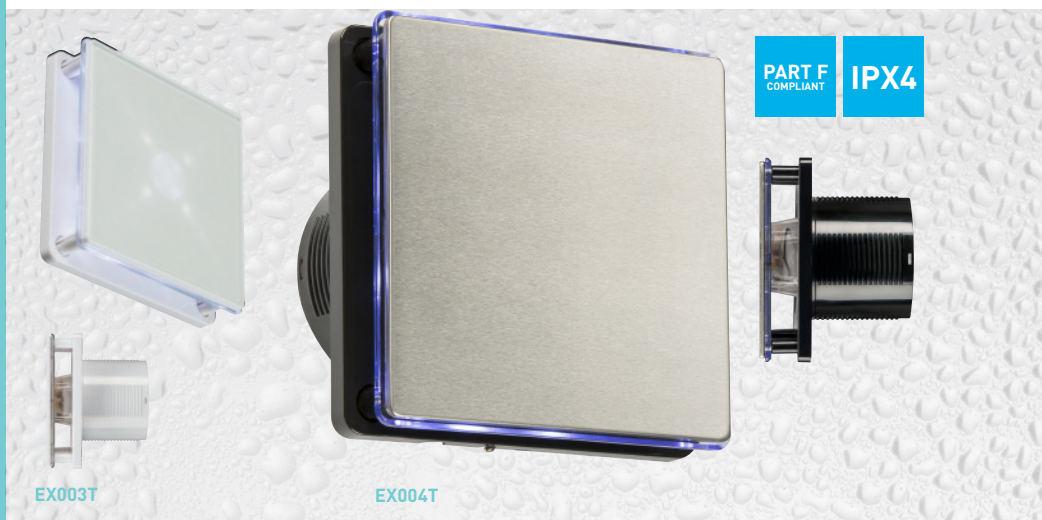

EX003T

EX004T

**PART F**  
COMPLIANT

**IPX4**

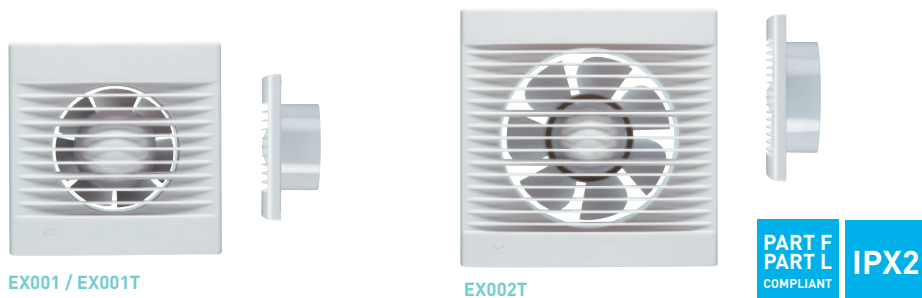

EX001 / EX001T

EX002T

**PART F**  
**PART L**  
COMPLIANT

**IPX2**

- Innovative low profile design
- Easy to clean/maintain
- Quiet and efficient
- Compliant to latest Building Regulations (Part F)
- EX001, EX001T and EX002T models are also Part L compliant
- Built-in overrun timer (2-30mins) on selected models
- Simple to install

Code	Model	Qty
EX001	100mm/4" Extractor Fan	1
EX001T	100mm/4" Extractor Fan with Overrun Timer	1
EX002T	150mm/6" Extractor Fan with Overrun Timer	1
EX003T	100mm/4" LED Backlit Extractor Fan with Overrun Timer - White	1
EX004T	100mm/4" LED Backlit Extractor Fan with Overrun Timer - Black and Stainless Steel	1

**LED LIT**  
**P.O.S.**  
**AVAILABLE**



## VENTILATION: ACCESSORIES

100mm/4"



EX007W

EX007B

EX007T

150mm/6"



EX008W

EX008B

EX008T

100mm/4"



EX009W

EX009B

EX009T

150mm/6"



EX0010W

EX0010B

EX0010T

Code	Model	Qty
EX007W	100mm/4" Gravity Shutter - White	1
EX007B	100mm/4" Gravity Shutter - Black	1
EX007T	100mm/4" Gravity Shutter - Terracotta	1
EX008W	150mm/6" Gravity Shutter - White	1
EX008B	150mm/6" Gravity Shutter - Black	1
EX008T	150mm/6" Gravity Shutter - Terracotta	1
EX009W	100mm/4" Extractor Fan Grille with Fly Screen - White	1
EX009B	100mm/4" Extractor Fan Grille with Fly Screen - Black	1
EX009T	100mm/4" Extractor Fan Grille with Fly Screen - Terracotta	1
EX0010W	150mm/6" Extractor Fan Grille with Fly Screen - White	1
EX0010B	150mm/6" Extractor Fan Grille with Fly Screen - Black	1
EX0010T	150mm/6" Extractor Fan Grille with Fly Screen - Terracotta	1
EX4DUCT	100mm/4" Aluminium Ducting Kit	1
EX6DUCT	150mm/6" Aluminium Ducting Kit	1



EX4DUCT



EX6DUCT

## PLUG-IN WIRELESS DOOR CHIMES

### PLUG-IN WIRELESS DOOR CHIME

80m range\*  
IP44 bell push  
36 polyphonic chimes

Code	Model	Colour	Qty
DC002	Plug-in wireless door chime	black	1
DC003	Plug-in wireless door chime	white	1



DC002



DC003



DC007



### WIRELESS DUAL ENTRANCE DOOR CHIME KIT

100m range\*  
2 x IP44 bell push  
2 different chimes

Code	Model	Qty
DC007	Wireless dual entrance door chime kit	1



All Knightsbridge® door chimes are supplied in high quality, full colour retail packaging  
\*Range dependent on environment



## BATTERY POWERED WIRELESS DOOR CHIMES



### WIRELESS DOOR CHIME

200m range\*  
IP44 bell push  
36 polyphonic chimes

Code	Model	Qty
DC001	Wireless door chime (200m range*)	1



### WIRELESS DOOR CHIME

200m range\*  
IP44 bell push  
16 pre-programmed chimes,  
add more with SD card (not included)

Code	Model	Qty
DC008	Wireless MP3 door chime (200m range*)	1

## MAINS POWERED WIRELESS DOOR CHIMES

### WIRELESS MECHANICAL DOOR CHIME

100m range\*  
IP44 bell push  
Traditional chime

Code	Model	Qty
DC005	Wireless mechanical door chime (100m range*)	1



## PIR ACTIVATED WIRELESS DOOR CHIMES



### WIRELESS MECHANICAL DOOR CHIME

100m range\*  
PIR activation  
36 polyphonic chimes

Code	Model	Qty
DC006	Wireless PIR door chime (100m range*)	1

\*dependent on environment

# DETECTION SERIES



## DETECTION SERIES: SMOKE ALARMS

### MINI OPTICAL SMOKE ALARM

Code	Model	Qty
DT007	Mini optical smoke alarm Optical sensor 10yr battery 5yr guarantee Compliant to EN 14604:2005+AC:2008	1



70MM DIAMETER



Ø100mm

### OPTICAL SMOKE ALARM

Code	Model	Qty
DT002	Optical smoke alarm Optical sensor 10yr battery 5yr guarantee Compliant to EN 14604:2005+AC:2008	1



Ø100mm

### WIRELESS OPTICAL SMOKE AND HEAT ALARM

Code	Model	Qty
DT004	Optical smoke and heat alarm Optical sensor and temperature sensor 5yr battery 3yr guarantee Wireless Interlinkable Compliant to EN 14604:2005+AC:2008	1

# DETECTION SERIES: SMOKE, HEAT AND CARBON MONOXIDE ALARMS



Ø127mm

## OPTICAL SMOKE ALARM

Code	Model	Qty
DT005	Optical smoke alarm	1

Optical sensor  
Mains powered with 5yr battery back up  
3yr guarantee  
Wired Interlinkable  
Compliant to EN 14604:2005+AC:2008

## PATTRESS BASE

Code	Model	Qty
DT006	Pattress base for DT005	1



Ø107mm

## HEAT ALARM

Code	Model	Qty
DT003	Heat alarm	1

Temperature sensor  
5yr battery  
3yr guarantee  
Compliant to EN 61000-6-3:200+A1:2011,  
EN 50130 4:2011

## CARBON MONOXIDE ALARM



## CARBON MONOXIDE ALARM

Code	Model	Qty
DT001	Carbon monoxide alarm	1

Photoelectric sensor  
7yr battery  
5yr guarantee  
Compliant to  
EN 50291-1:2010+A1: 2012



Code	Model	Qty
OS002	<b>PROFESSIONAL RECESS MOUNTED 360° PIR SENSOR</b>	1

Range of 7-8m  
 Adjustable lux level  
 Adjustable time delay  
 30sec-30mins  
 Switching capacity - 1800W  
 - halogen or incandescent /  
 200W LED

OS003	<b>ADDITIONAL SLAVE UNIT FOR OS002</b>	1
-------	----------------------------------------	---

Range of 7-8m  
 Adjustable lux level

**63MM**  
 CUTTER SIZE

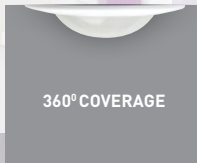

Code	Model	Qty
OS009	<b>RECESS MOUNTED 360° PIR SENSOR</b>	1

Range of 6m  
 Adjustable time delay 10sec-8mins  
 Switching capacity - 1200W  
 - halogen or incandescent /  
 300W LED

**62MM**  
 CUTTER SIZE

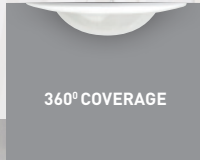

## INDOOR SENSORS



Code	Model	Qty
------	-------	-----

<b>PIR0901</b>	<b>10A WALL MOUNTED 120° PIR SENSOR</b>	<b>1</b>
----------------	-----------------------------------------	----------

Range of 5m  
Adjustable time delay 1-16mins  
Switching capacity -  
Max. 1000W suitable for Incandescent  
/CFL/Fluorescent Lamps and Fans.

<b>PIR0901S</b>	<b>10A WALL MOUNTED 120° PIR SENSOR 1 WITH OVERRIDE SWITCH</b>	<b>1</b>
-----------------	----------------------------------------------------------------	----------

Range of 5m  
Adjustable time delay 1-16mins  
Switching capacity -  
Max. 1000W suitable for Incandescent  
/CFL/Fluorescent Lamps and Fans.

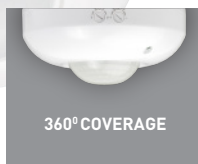

360° COVERAGE

Code	Model	Qty
------	-------	-----

<b>OS0011</b>	<b>SURFACE MOUNTED 360° PIR SENSOR</b>	<b>1</b>
---------------	----------------------------------------	----------

Range of 6m  
Adjustable lux level  
Adjustable time delay 10sec-8mins  
Switching capacity - 1200W - halogen  
or incandescent / 300W LED



**SOUND & MOVEMENT  
DETECTION**

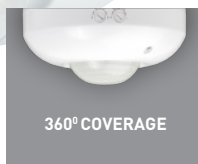

360° COVERAGE

Code	Model	Qty
------	-------	-----

<b>OS007</b>	<b>DUAL TECHNOLOGY SURFACE MOUNT SENSOR</b>	<b>1</b>
--------------	---------------------------------------------	----------

Range of 7-8m  
Adjustable sound and lux level,  
Adjustable time delay 30sec-30mins  
Switching capacity - 1800W - halogen  
or incandescent / 200W LED



Code	Model	Qty
OS004	IP44 180° PIR SENSOR - WHITE	1
OS004B	IP44 180° PIR SENSOR - BLACK	1

Range of 12m  
 Adjustable lux level  
 Adjustable time delay 10sec-8mins  
 Switching capacity - 1200W - halogen  
 or incandescent / 300W LED

Code	Model	Qty
OS001	IP55 200° PROFESSIONAL OUTDOOR MOTION SENSOR - WHITE	1
OS001B	IP55 200° PROFESSIONAL OUTDOOR MOTION SENSOR - BLACK	1

Range of 12m  
 Adjustable lux level  
 Adjustable time delay 3sec-30mins  
 Switching capacity - 1800W  
 - halogen or incandescent / 225W LED  
 Manual override  
 Wall, ceiling or corner mounting



FULLY ADJUSTABLE

## MICROWAVE SENSORS



Code	Model	Qty
OS005	<b>HIGH FREQUENCY SENSOR WITH 360° DETECTION</b>	1
Range of 6m Adjustable time delay 3-30mins Switching capacity - 1800W - halogen or incandescent / 200W LED		

Code	Model	Qty
MSENSOR	<b>MICROWAVE SENSOR</b>	1
Switching capacity - Max. 1000W		

## PHOTOCELL SENSORS



Code	Model	Qty
OS006	<b>IP55 TWILIGHT SWITCH</b>	1
Adjustable lux level Dusk to Dawn, adjustable time period: 2, 4, 6, or 8 hours Switching capacity - 1800W - halogen or incandescent / 200W LED Ambient light memory function LED		

Code	Model	Qty
TRPCKIT	<b>IP65 NEMA SOCKET PHOTOCELL KIT</b>	1
Adjustable lux level Dusk to Dawn Switching capacity - 2000W tungsten halogen, 2 x 400 W SON, 3 x 150 W HQL, 1800vA		

Code	Model	Qty
TRRPC	<b>IP65 MINIATURE REMOTE PHOTOCELL</b>	1
Adjustable lux level Dusk to Dawn Switching capacity - 2000W tungsten halogen, 2 x 400 W SON, 3 x 150 W HQL, 1800vA		



**Section Index**

FireKnight Fire-Rated LED Downlights and Accessories	120-121
Proknight LED Fire-Rated Downlights	122-123
IC Introduction	124
Evolve Fire-Rated Fixed Downlight System	125
Evolve Fire-Rated Tilt Downlight System	126
IC Fire-Rated Downlights	127
IP65 IC Fire-Rated Shower Downlights	128
Fire-Rated LV Downlights	129
IP65 Fire-Rated LV and Low Energy Shower Downlights	130



P122

# FIREKNIGHT FIRE-RATED LED DOWNLIGHTS AND ACCESSORIES



VFRCOBWW with VFRBEZW



VFRCOBCW with VFRSBEZW



VFRBEZCBR

VFRBEZBK

VFRBEZCH

VFRBEZBR

VFRBEZGM

VFRBEZMW

VFRBEZAB

Paintable



VFRSBEZCBR

VFRSBEZBK

VFRSBEZCH



## FIREKNIGHT IP65 FIRE-RATED DOWNLIGHTS

IP65 7W LED COB dimmable fire-rated downlights. With a high lumen output of up to 490lm, these low energy downlights offer a true 'halogen feel' and are available in a choice of warm white (3000K) or cool white (4000K). They are supplied with a pre-wired 'plug and play' dimmable LED driver and white bezel as standard. The bezel is easily exchanged with a wide range of colours to suit almost any environment. All models are fire-rated 90mins. An extended warranty of up to 7 years is available on request.

**Dimensions:** Bezel Ø: 80mm Rim Ø:76mm

Cut out Ø: 63mm Minimum void: 85mm

**Lamp type:** 7W COB LED

**Lamp data:** Warm white: 460lm, Cool white: 490lm

**Construction:** Die-cast aluminium

## BEZELS

Code	Model	Qty
VFRBEZW	White round bezel	1
VFRBEZCBR	Brushed chrome round bezel	1
VFRBEZBK	Black round bezel	1
VFRBEZCH	Chrome round bezel	1
VFRBEZBR	Brass round bezel	1
VFRBEZGM	Gunmetal round bezel	1
VFRBEZMW	Matt white (paintable) round bezel	1
VFRBEZAB	Antique brass round bezel	1
VFRSBEZW	White square bezel	1
VFRSBEZCBR	Brushed chrome square bezel	1
VFRSBEZBK	Black square bezel	1
VFRSBEZCH	Chrome square bezel	1

Code	Model	Qty	LED
VFRCOBWW	Warm white 3000K	1	
VFRCOBCW	Cool white 4000K	1	
VFR7EM	Switched maintained emergency kit	1	



VFR7EM Kit only. Downlight not included

# FIREKNIGHT FIRE-RATED LED DOWNLIGHTS AND ACCESSORIES



VFRCBCW3

**Dimensions:** Bezel Ø: 88mm Cut out Ø: 74mm  
Minimum void: 85mm

**Tilt:** 25°

**Lamp type:** 7W COB LED (non-replaceable)

**Lamp data:** Warm white: 460lm, Cool white: 490lm

**Construction:** Die-cast aluminium



VFRCBCW1



VFRCBCW2

## IP20 TILT FIREKNIGHTS

FireKnight tilt is built to the same quality specifications as our fixed model. The tilt FireKnight is rated IP20. Bezels are not interchangeable. Available in white, chrome and brushed chrome finishes. An extended 7 year warranty is available on request.

### COOL WHITE TILT

LED

Code	Model	Qty
VFRCBCW1	White bezel	1
VFRCBCW2	Chrome bezel	1
VFRCBCW3	Brushed chrome bezel	1

### WARM WHITE TILT

Code	Model	Qty
VFRCBWW1	White bezel	1
VFRCBWW2	Chrome bezel	1
VFRCBWW3	Brushed chrome bezel	1



VFRC

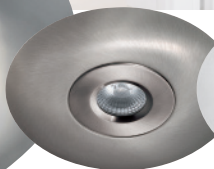

VFRCBC



VFRCW

LAMPS not included



Hole converter for the **VFRCOB + VFR8** fixed range of LED fire-rated downlights  
The converter allows the downlights to be used for cut-outs 65mm-130mm

**Dimensions:** Bezel Ø: 180mm

**Construction:** Pressed steel

### FIREKNIGHT HOLE CONVERTERS

Code	Model	Qty
VFRC	Chrome	1
VFRCBC	Brushed chrome	1
VFRCW	White	1



### FIREKNIGHT DIMMER LED

VFR400M is a dedicated 1G, 2 way, smooth, flicker-free dimming module that is ideal for the FireKnight & ProKnight ranges.

Code	Model	Qty
VFR400M	LED dimmer module	1

# PROKNIGHT LED FIRE-RATED DOWNLIGHTS



**PROKNIGHT**<sup>®</sup>  
POWER OF LED...HALOGEN FEEL



VFR8WW shown  
with VFR8BEZCBR

VFR8BEZCH

VFR8BEZBL

VFR8BEZBR

VFR8BEZMW

- 230V 8W IP65 fire-rated LED downlight
- Cool white (4000K) or warm white (2700K)
- Dimmable
- Lightweight - Low profile
- Complete with driver and loop in/loop out screwless terminal block
- Up to 35,000 hours average lamp life
- NEW aluminium heat sink
- PART B - BS476 Part 23 (Fire safety) 30, 60 & 90 minutes
- Supplied without bezel
- Exclusive range of interchangeable bezels
- Fixed and tilt models available

## PROKNIGHT FIXED DOWNLIGHTS

**LED**

- Dimensions:** Overall Ø: 80mm (with bezel) D: 47mm  
Cut out Ø: 63mm
- Lamp type:** 8W COB LED
- Lamp data:** Warm white: 460lm, Cool white: 490lm
- Construction:** Die-cast aluminium

Code	Model	Qty
VFR8CW	Cool white 4000K IP65 Fixed downlight	1
VFR8WW	Warm white 2700K IP65 Fixed downlight	1

## PROKNIGHT FIXED IP65 BEZELS

Code	Model	Qty
VFR8BEZCBR	Brushed chrome bezel	1
VFR8BEZCH	Chrome bezel	1
VFR8BEZBL	Black bezel	1
VFR8BEZBR	Brass bezel	1
VFR8BEZMW	Matt white bezel	1
VFR7EM	Switched maintained emergency kit	1

## VFR8CW

Supplied as a kit with driver.  
Bezel not included.



**VFR7EM** Kit only.  
Downlight not included

230V  
50Hz



IP  
65

# PROKNIGHT LED FIRE-RATED DOWNLIGHTS



VFR8TWW

VFR8TBEZCH

VFR8TBEZBL

VFR8TBEZBR

VFR8TBEZMW

VFR8TBEZCBR

VFR8TWW shown  
with VFR8TBEZCH



VFR8TWW

Supplied as a  
kit with driver.  
Bezel not  
included.



## PROKNIGHT TILT DOWNLIGHTS

LED

**Dimensions:** Overall Ø: 88mm (with bezel) D: 47mm  
Cut out Ø: 72mm

**Construction:** Die-cast aluminium

**Tilt:** 25°

**Lamp type:** 8W COB LED

**Lamp data:** Warm white: 460lm, Cool white: 490lm

Code	Model	Qty
VFR8TCW	Cool white 4000K IP20 Tilt downlight	1
VFR8TWW	Warm white 2700K IP20 Tilt downlight	1

## PROKNIGHT TILT IP20 BEZELS

Code	Model	Qty
VFR8TBEZCBR	Brushed chrome bezel	1
VFR8TBEZCH	Chrome bezel	1
VFR8TBEZBL	Black bezel	1
VFR8TBEZBR	Brass bezel	1
VFR8TBEZMW	Matt white bezel	1

230V  
50Hz



IP  
20

## WHAT DOES IC RATED MEAN?

# IC RATED

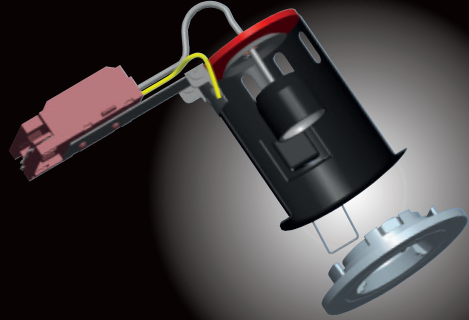

**As building regulations (L1 A & B) become ever more focused on energy efficiency and energy saving, they have impacted the traditional products installed into UK homes. Loft spaces were recognised as an area for heat loss, even more so when several holes for downlights were cut into the ceiling.**

Building regulations Part L1A and L1B state: 'The building fabric should be constructed so that there is no reasonably avoidable thermal bridges in the insulation layer'. This means that where possible the insulation layer should lay un-broken to prevent heat loss, which causes issues for traditional halogen downlights in several ways.

Latest standards now require homes to be compliant both in energy efficiency and energy saving and the modern downlight has had to adapt. Traditionally a downlight causes many issues, cutting a hole to install compromises the fire barrier of the ceiling and acoustic rating but also causes an increase in heat loss and moisture transfer to the ceiling void. Added to this, manufacturer's recommendations would be to remove the insulation layer away from the

immediate area around and above the downlight allowing it to dissipate heat build-up and to remove any possible fire hazard due to debris. Doing so creates thermal bridges, where lower thermal resistance allows heat to escape.

Most fire-rated downlights address the issues to re-instate the fire barrier, acoustic rating and moisture transfer, however the heat loss remains an issue as most are not able to be covered with insulation. To do so would allow the heat generated by the lamp to be trapped by the insulation causing early lamp failure and potential discolouration of the downlight and the ceiling around it.

Knightsbridge® Insulation contact (IC) rated products take this one step further. Without a requirement for additional accessories, these innovative products allow glass or rock mineral wool insulation to be laid, without gaps, directly over the downlight. Its construction allows heat to dissipate through the ventilated body whilst maintaining the structural integrity of the ceiling and not contravening building regulations.

***Building regulations Part L1A and L1B state that... "The building fabric should be constructed so that there is no reasonably avoidable thermal bridges in the insulation layer"***



## EVOLVE FIRE-RATED FIXED DOWNLIGHT SYSTEM

**IC RATED**



- Compatible with all standard GU10 Halogen / LED / CFL lamps
- 230V 50W max fire-rated downlight can
- EASY fix loop in / loop out screwless terminal
- Dimmable subject to light source
- Interchangeable tilt and fixed bezels
- IC rated

EVOICF



### EVOLVE IC RATED FIXED DOWNLIGHT

**Dimensions:** Overall Ø: 78mm Rim Ø: 78mm  
Cut out Ø: 72mm, Minimum void: 130mm  
**Lamp type:** GU10 **Lamp fixing:** Twist and lock  
**Enclosure type:** Enclosed  
**LED compatible:** Yes  
**Construction:** Pressed steel  
c/w EASY fix loop in / loop out screwless terminal

Code	Model	Length	Qty
EVOICF	Evolve fixed GU10	105mm	1

### EVOLVE FIXED BEZELS

**Dimensions:** Overall Ø: 82mm D: 4mm  
**Construction:** Die-cast aluminium. Twist and lock

Code	Model	Qty
EVOBCF	Brushed chrome bezel	1
EVOCHF	Chrome bezel	1
EVOABF	Antique brass bezel	1
EVOWHF	White bezel	1
EVOBKF	Black bezel	1
EVOGMF	Gunmetal bezel	1
EVOBRF	Brass bezel	1
EVOWWF	Matt white bezel	1



**evolve**  
next generation fire-rated downlight system

## EVOLVE IP65 BEZELS FOR DOMESTIC, RETAIL AND COMMERCIAL APPLICATIONS



EVOIPCH

EVOIPWH



EVOIPBC

**NEW**  
**IP65 BEZEL**

### IP65 EVOLVE FIXED BEZELS

**Dimensions:** Overall Ø: 80mm D: 5mm  
**Construction:** Die-cast aluminium and glass.  
Twist and lock. Complete with gasket

Code	Model	Qty
EVOIPBC	Brushed chrome bezel	1
EVOIPCH	Chrome bezel	1
EVOIPWH	White bezel	1

# EVOLVE FIRE-RATED DOWNLIGHTS



EVOVHT



EVOBCT



EVOBRT



Paintable

EVOVMT



EVOABT



EVOGMT



EVOCHT



EVOBKT



EVOICT

IC  
RATED



EVOICT



## EVOLVE TILT BEZELS

**Dimensions:** Overall Ø: 91mm D: 4mm

**Construction:** Die-cast aluminium. Twist and lock

Code	Model	Qty
EVOVHT	White bezel	1
EVOVMT	Matt white bezel	1
EVOCHT	Chrome bezel	1
EVOBCT	Brushed chrome bezel	1
EVOABT	Antique brass bezel	1
EVOBKT	Black bezel	1
EVOBRT	Brass bezel	1
EVOGMT	Gunmetal bezel	1

## EVOLVE IC RATED TILT DOWNLIGHT

**Dimensions:** Overall Ø: 80mm Rim Ø: 88mm

Cut out Ø: 82mm, Minimum void: 130mm

**Lamp type:** GU10 **Lamp fixing:** Twist and lock

**Enclosure type:** Enclosed

**LED compatible:** Yes

**Construction:** Pressed steel

c/w EASYfix loop in / loop out screwless terminal

Code	Model	Length	Qty
EVOICT	Evolve Tilt GU10	105mm	1

230V  
50Hz

IP  
20



Lamps not included unless otherwise stated



**IC**  
RATED



VFRDGICCBR

VFRDGICC

VFRDGICB

VFRDGICW

**FIXED IC FIRE-RATED DOWNLIGHTS**

**Dimensions:** Overall Ø: 87mm Overall height: 116mm

Cut out Ø: 72mm Recessed depth: 120mm

**Lamp type:** GU10 50W max **Lamp fixing:** Twist and lock

**Enclosure type:** Enclosed

**LED compatible:** Yes

**Construction:** Pressed steel body. Die-cast bezel

Code	Model	Qty
VFRDGICCBR	Fixed brushed chrome IC downlight	1
VFRDGICC	Fixed chrome IC downlight	1
VFRDGICB	Fixed brass IC downlight	1
VFRDGICW	Fixed white IC downlight	1



**IC**  
RATED



VFRSGICCBR

VFRSGICC

VFRSGICB

VFRSGICW

**TILT IC FIRE-RATED DOWNLIGHTS**

**Dimensions:** Overall Ø: 102mm Overall height: 90mm

Cut out Ø: 84mm Recessed depth: 120mm

**Lamp type:** GU10 50W max **Lamp fixing:** Twist and lock

**Enclosure type:** Enclosed

**LED compatible:** Yes

**Construction:** Pressed steel body. Die-cast bezel

Code	Model	Qty
VFRSGICCBR	Tilt brushed chrome IC downlight	1
VFRSGICC	Tilt chrome IC downlight	1
VFRSGICB	Tilt brass IC downlight	1
VFRSGICW	Tilt white IC downlight	1



230V  
50Hz

IP  
20



Lamps not included unless otherwise stated

## IP65 IC FIRE-RATED SHOWER DOWNLIGHTS

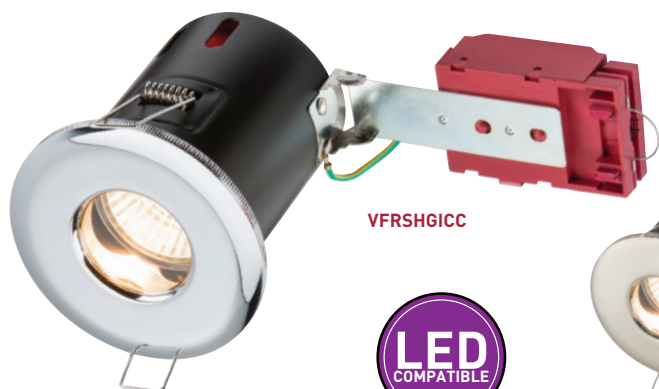

VFRSHGICC



**IC**  
RATED



VFRSHGICCBR

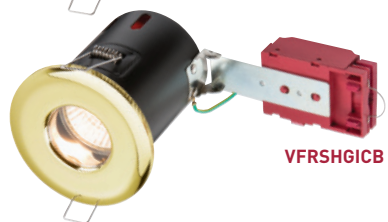

VFRSHGICB



VFRSHGICW

### IP65 IC FIRE-RATED SHOWER DOWNLIGHTS

**Dimensions:** Overall Ø: 87mm Overall height: 100mm

Cut out Ø: 72mm Recessed depth: 130mm

**Lamp type:** GU10 35W max **Lamp fixing:** Spring clip

**Enclosure type:** Enclosed

**LED compatible:** Yes

**Construction:** Pressed steel body. Die-cast bezel

Code	Model	Qty
VFRSHGICCBR	IP65 brushed chrome shower downlight	1
VFRSHGICC	IP65 chrome shower downlight	1
VFRSHGICB	IP65 brass shower downlight	1
VFRSHGICW	IP65 white shower downlight	1

230V  
50Hz

IP  
65



Lamps not included unless otherwise stated



# IP20 FIRE-RATED LV DOWNLIGHTS



VFRCL02CBR



VFRCLG06CBR

## FIXED LV FIRE-RATED DOWNLIGHTS

**Dimensions:** Overall Ø: 88mm

Cut out Ø: 72mm Recessed depth: 105mm

**Lamp type:** MR16 50W max **Lamp fixing:** Twist and lock

**Enclosure type:** Enclosed

**Transformer:** 12V 60VA required - (Code:T02)

**LED compatible:** Yes

**Construction:** Pressed steel body. Die-cast bezel

Code	Model	Qty
VFRCL02W	Fixed white LV downlight	1
VFRCL02C	Fixed chrome LV downlight	1
VFRCL02CBR	Fixed brushed chrome LV downlight	1

## TILT LV FIRE-RATED DOWNLIGHTS

**Dimensions:** Overall Ø: 102mm

Cut out Ø: 84mm Recessed depth: 110mm

**Lamp type:** MR16 50W max **Lamp fixing:** Twist and lock

**Enclosure type:** Enclosed **Tilt angle:** 15°

**Transformer:** 12V 60VA required - (Code:T02)

**LED compatible:** Yes

**Construction:** Pressed steel body. Die-cast bezel

Code	Model	Qty
VFRCLG06W	Tilt white LV downlight	1
VFRCLG06C	Tilt chrome LV downlight	1
VFRCLG06CBR	Tilt brushed chrome LV downlight	1

12V

IP  
20



Lamps not included unless otherwise stated

## IP65 FIRE-RATED LV SHOWER DOWNLIGHTS



VFRSH01C



VFRSH01W

### IP65 FIXED LV FIRE-RATED SHOWER DOWNLIGHTS

**Dimensions:** Overall Ø: 87mm  
Cut out Ø: 72mm Recessed depth: 135mm

**Lamp type:** MR16 50W max

**Lamp fixing:** Spring clip

**Enclosure type:** Enclosed

**Tilt angle:** 15°

**Transformer:** 12V 60VA required - (Code:T02)

**LED compatible:** Yes

**Construction:** Pressed steel body. Die-cast bezel

Code	Model	Qty
------	-------	-----

VFRSH01W	IP65 LV white shower downlight	1
----------	--------------------------------	---

VFRSH01C	IP65 LV chrome shower downlight	1
----------	---------------------------------	---

VFRSH01CBR	IP65 LV brushed chrome shower downlight	1
------------	-----------------------------------------	---



VFRSH01CBR

12V

IP  
65



VFRSHLECBR



VFRSHLEW

### IP65 LOW ENERGY FIRE-RATED SHOWER DOWNLIGHTS

**Dimensions:** Overall Ø: 87mm  
Cut out Ø: 72mm Recessed depth: 150mm

**Lamp type:** GU10 11W max

**Lamp fixing:** Spring clip

**Enclosure type:** Enclosed

**LED compatible:** Yes

**Construction:** Pressed steel body. Die-cast bezel

Code	Model	Qty
------	-------	-----

VFRSHLEW	Low energy white downlight	1
----------	----------------------------	---

VFRSHLEC	Low energy chrome downlight	1
----------	-----------------------------	---

VFRSHLECBR	Low energy brushed chrome downlight	1
------------	-------------------------------------	---



VFRSHLEC

230V  
50Hz

IP  
65



**Section Index**

Mains/Low Voltage Downlights	132
Low Voltage Downlights	133 - 135
GU10 Mains Voltage Downlights	136
Mains Voltage Downlights	137



P132

# MAINS/LOW VOLTAGE DOWNLIGHTS

RD1CBR



RD2CBR



RD1C



RD1B



RD1W



RD2C



RD2B



RD2W

A range of classic twist and lock recessed downlights. Available in fixed and tilt versions. Manufactured from Die-cast Aluminium. Pre-wired with 230V GU10 lampholder and supplied with optional 12V MR16 lampholder included. 50W MAX LED compatible.

## RD1

<b>Dimensions:</b>	Overall Ø: 80mm Cut out Ø: 70mm Recessed depth: 95mm
<b>Lamp type:</b>	GU10/MR16 50W max
<b>Lamp fixing:</b>	Twist & lock
<b>Enclosure type:</b>	Open
<b>LED compatible:</b>	Yes
<b>Construction:</b>	Die-cast aluminium

Code	Model	Qty
RD1W	White fixed downlight	1
RD1B	Brass fixed downlight	1
RD1C	Chrome fixed downlight	1
RD1CBR	Brushed chrome fixed downlight	1

## RD2

<b>Dimensions:</b>	Overall Ø: 95mm Cut out Ø: 80mm Recessed depth: 100mm
<b>Lamp type:</b>	GU10/MR16 50W max
<b>Lamp fixing:</b>	Twist & lock
<b>Enclosure type:</b>	Open
<b>Tilt angle:</b>	25°
<b>LED compatible:</b>	Yes
<b>Construction:</b>	Die-cast aluminium

Code	Model	Qty
RD2W	White tilt downlight	1
RD2B	Brass tilt downlight	1
RD2C	Chrome tilt downlight	1
RD2CBR	Brushed chrome tilt downlight	1

230V

IP  
20

12V



# LOW VOLTAGE DOWNLIGHTS

## L02

**Dimensions:** Overall Ø: 82mm Cut out Ø: 60mm  
Recessed depth: 100mm

**Lamp type:** MR16 50W MAX

**Lamp fixing:** Spring clip

**Enclosure type:** Open

**Transformer:** 12V 60VA required - **(Code:T02)**

**LED compatible:** Yes

**Construction:** Pressed steel  
Complete with bridge and lampholder

Code	Model	Qty
L02W1	White fixed downlight	1
L02BK1	Black fixed downlight	1
L02B1	Brass fixed downlight	1
L02C1	Chrome fixed downlight	1
L02CBR1	Brushed chrome fixed downlight	1



L02C1



L02W1



L02BK1



L02B1



L02CBR1



L02W1



L02BK1



L02B1

L02CBR1

## L06

**Dimensions:** Overall Ø: 105mm Cut out Ø: 75mm  
Recessed depth: 100mm

**Lamp type:** MR16 50W max

**Lamp fixing:** Spring clip

**Enclosure type:** Open

**Tilt angle:** 15°

**Transformer:** 12V 60VA required - **(Code:T02)**

**LED compatible:** Yes

**Construction:** Pressed steel.  
Complete with lampholder

Code	Model	Qty
L06W	White tilt downlight	1
L06C	Chrome tilt downlight	1
L06CBR	Brushed chrome tilt downlight	1

L06W



L06C



L06CBR

L01CBR



L01W



L01C



## L01

**Dimensions:** Overall Ø: 60mm  
Cut out Ø: 42mm  
Recessed depth: 42mm

**Lamp type:** MR11 35W max

**Lamp fixing:** Spring clip

**Enclosure type:** Open

**Transformer:** 12V 60VA required - **(Code:T02)**

**LED compatible:** Yes

**Construction:** Pressed steel  
Complete with lampholder

Code	Model	Qty
L01W	White fixed downlight	1
L01C	Chrome fixed downlight	1
L01CBR	Brushed chrome fixed downlight	1

12V

IP  
20



Lamps not included unless otherwise stated

# LOW VOLTAGE DOWNLIGHTS

## SWS01C



## SWS01

**Dimensions:** Overall Ø: 127mm Cut out Ø: 110mm  
Recessed depth: 85mm

**Lamp type:** MR16 50W max

**Lamp fixing:** Twist & lock

**Enclosure type:** Open

**Tilt angle:** 90°

**Transformer:** 12V 60VA required - **(Code:T02)**

**LED compatible:** Yes

**Construction:** Die-cast aluminium. Complete with lampholder

Code	Model	Qty
SWS01W	White swivel and scoop downlight	1
SWS01C	Chrome swivel and scoop downlight	1

## SWS01W



## LE04

**Dimensions:** Overall Ø: 100mm Cut out Ø: 85mm  
Recessed depth: 60mm

**Lamp type:** MR16 50W max

**Lamp fixing:** Spring clip

**Enclosure type:** Open

**Tilt angle:** 15°

**Transformer:** 12V 60VA required - **(Code:T02)**

**LED compatible:** Yes

**Construction:** Pressed steel. Complete with bridge and lampholder

Code	Model	Qty
LE04W1	White eyeball downlight	1
LE04BK1	Black eyeball downlight	1
LE04B1	Brass eyeball downlight	1
LE04C1	Chrome eyeball downlight	1
LE04CBR1	Brushed chrome eyeball downlight	1



LE04CBR1

## 12V 60VA TRANSFORMER

Pre-wired. Thermal fuse. Dimmable. Overload, short circuit reset.

**Dimensions:** L:120mm W:30mm H:23mm

Code	Model	Qty
T02	20-60VA Transformer	1



12V

IP 20



Lamps not included unless otherwise stated



# LOW VOLTAGE DOWNLIGHTS

## HOLE CONVERTER KITS

- Dimensions:** Overall Ø: 140mm  
Cut out Ø: 78mm to 120mm
- Lamp type:** MR16 or GU10
- Lamp fixing:** Spring clip
- Enclosure type:** Open
- Transformer:** 12V 60VA required (MR16 only) - **(Code:T02)**
- LED compatible:** Yes
- Construction:** Pressed steel.  
Complete with LV and GU10 lampholders and bridge

Code	Model	Qty
HCW	White hole converter	1
HCB	Brass hole converter	1
HCC	Chrome hole converter	1
HCBC	Brushed chrome hole converter	1



HCBC



HCB



HCC



HCW

## CL03

- Dimensions:** L: 80mm W: 80mm  
Cut out Ø: 70mm  
Recessed depth: 90mm
- Lamp type:** MR16 35W max
- Lamp fixing:** Twist & lock
- Enclosure type:** Open
- Transformer:** 12V 60VA required - **(Code:T02)**
- LED compatible:** Yes
- Construction:** Die-cast aluminium.  
Complete with bridge and lampholder

Code	Model	Qty
CL03C1	Chrome fixed downlight	1
CL03CBR1	Brushed chrome fixed downlight	1



CL03CBR1

## CLG07

- Dimensions:** L: 85mm W: 85mm  
Cut out Ø: 75mm  
Recessed depth: 90mm
- Lamp type:** MR16 35W max
- Lamp fixing:** Spring clip
- Enclosure type:** Open **Tilt angle:** 25°
- Transformer:** 12V 60VA required - **(Code:T02)**
- LED compatible:** Yes
- Construction:** Pressed steel. Complete with bridge and lampholder

Code	Model	Qty
CLG07W1	White tilt downlight	1
CLG07C1	Chrome tilt downlight	1
CLG07CBR1	Brushed chrome tilt downlight	1



CLG07W1

12V

IP 20



Lamps not included unless otherwise stated

## GU10 MAINS VOLTAGE DOWNLIGHTS



DGZ10W



DGZ10B



DGZ10CBR



DGZ10C

### DGZ10

**Dimensions:** Overall  $\varnothing$ : 80mm Cut out  $\varnothing$ : 60mm  
Recessed depth: 120mm  
**Lamp type:** GU10 50W max  
**Enclosure type:** Open  
**Transformer:** Not required **LED compatible:** Yes  
**Construction:** Pressed steel. Complete with bridge and lampholder

Code	Model	Qty
DGZ10W	White fixed downlight	20
DGZ10B	Brass fixed downlight	20
DGZ10C	Chrome fixed downlight	20
DGZ10CBR	Brushed chrome fixed downlight	20



SGZ10C



SGZ10W



SGZ10B



SGZ10CBR

### SGZ10

**Dimensions:** Overall  $\varnothing$ : 105mm Cut out  $\varnothing$ : 80mm  
Recessed depth: 115mm  
**Lamp type:** GU10 50W max  
**Enclosure type:** Open  
**Tilt angle:** 25°  
**Transformer:** Not required  
**LED compatible:** Yes  
**Construction:** Pressed steel. Complete with bridge and lampholder

Code	Model	Qty
SGZ10W	White tilt downlight	20
SGZ10B	Brass tilt downlight	20
SGZ10C	Chrome tilt downlight	20
SGZ10CBR	Brushed chrome tilt downlight	20



FR150

### FR150 FIRE HOOD

**Dimensions:** Overall  $\varnothing$  150mm x H 150mm  
**Construction:** The intumescent material used in the fire hood is breathable and its construction allows the heat from the lamp to be dissipated preventing the terminal block and downlight from overheating. The fire hood is flexible and light and can be used in plasterboard, suspended or concrete ceilings. 60 minute rated.

Code	Model	Qty
FR150	Intumescent fire hood	1



Lamps not included unless otherwise stated

## MAINS VOLTAGE DOWNLIGHTS



### MAINS 240V FIXED DOWNLIGHTS

**Dimensions:** Overall Ø: 80mm Cut out Ø: 60mm  
Recessed depth: 115mm

**Construction:** Pressed steel

Code	Model	Qty
MD01W	White R50 40W SES downlight	1

**Dimensions:** Overall Ø: 100mm Cut out Ø: 80mm  
Recessed depth: 125mm

**Construction:** Pressed steel

Code	Model	Qty
MD02W	White R63 60W E27 downlight	1
MD02B	Brass R63 60W E27 downlight	1
MD02C	Chrome R63 60W E27 downlight	1

**Dimensions:** Overall Ø: 125mm Cut out Ø: 90mm  
Recessed depth: 130mm

**Construction:** Pressed steel

Code	Model	Qty
MD03W	White R80 80W E27 downlight	1
MD03B	Brass R80 80W E27 downlight	1
MD03C	Chrome R80 80W E27 downlight	1

### MAINS 240V EYEBALLS

**Dimensions:** Overall Ø: 120mm Cut out Ø: 90mm  
Recessed depth: 90mm **Rotation:** 350° **Tilt angle:** 45°

**Construction:** Pressed steel

Code	Model	Qty
ME04W	White R50 40W SES eyeball downlight	1
ME04B	Brass R50 40W SES eyeball downlight	1
ME04C	Chrome R50 40W SES eyeball downlight	1

**Dimensions:** Overall Ø: 150mm Cut out Ø: 90mm  
Recessed depth: 100mm **Rotation:** 350° **Tilt angle:** 45°  
**Construction:** Pressed steel

Code	Model	Qty
ME05W	White R63 60W E27 eyeball downlight	1
ME05B	Brass R63 60W E27 eyeball downlight	1
ME05C	Chrome R63 60W E27 eyeball downlight	1

**Dimensions:** Overall Ø: 170mm Cut out Ø: 140mm  
Recessed depth: 100mm **Rotation:** 350° **Tilt angle:** 45°  
**Construction:** Pressed steel

Code	Model	Qty
ME06W	White R80 80W E27 eyeball downlight	1
ME06B	Brass R80 80W E27 eyeball downlight	1
ME06C	Chrome R80 80W E27 eyeball downlight	1

230V  
50Hz

IP  
20



Lamps not included unless otherwise stated



Passionate about customer service

**K**nightsbridge®  
the mark of quality



Excellence at no extra cost



### Section Index

LED Linkable Striplights	140-141
Slimline Fluorescent Lighting	142
Under Cabinet Lighting	143-144
Triangular and Flat LED Striplights	145
LED Striplight Accessories	146
24V RGB LED Flex Lighting	147
Single Colour LED Flex Lighting	148
LED Flex Lighting Accessories	149
Display Lighting	150



## LED LINKABLE STRIPLIGHTS

Ideal for kitchen lighting, cabinet lighting, cove lighting and retail applications. Linkable end to end by a coupler (included) or using link leads (available separately). Available in two colour temperatures - 4000K cool white and 3000K warm white. Up to a maximum of 12 units can be interlinked to each other. Supplied complete with 2m power cord, small coupler/connector and fixing clips.

- 230V mains voltage ultra slim LED link lights
- High output LED
- Integral driver, independently switched
- Energy efficient and long life
- Emits an even light distribution
- Versatile and simple to install, mountable horizontally or vertically

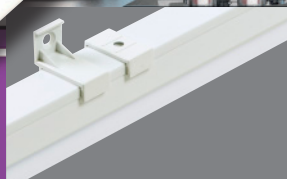

**VERTICAL AND HORIZONTAL FIXINGS INCLUDED**



**LINKABLE**

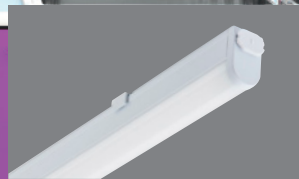

**CONNECTION COVER**

Supplied with 2m power cord, small coupler/connector and fixing clips.



230V

IP  
20



**FIXING KIT SUPPLIED**

**UCLED - LINKABLE LED STRIPS****Construction:** Polycarbonate body and diffuser**Dimensions:** W:28mm H:36mm

Code	Model	Qty
<b>4000K Cool white</b>		
<b>UCLED4</b>	230V 4W 4000K (277mm)	1
<b>UCLED9</b>	230V 9W 4000K (538mm)	1
<b>UCLED13</b>	230V 13W 4000K (838mm)	2
<b>UCLED18</b>	230V 18W 4000K (1138mm)	2
<b>UCLED22</b>	230V 22W 4000K (1438mm)	2

**3000K Warm white**

<b>UCLED4W3K</b>	230V 4W 3000K (277mm)	1
<b>UCLED9W3K</b>	230V 9W 3000K (538mm)	1
<b>UCLED13W3K</b>	230V 13W 3000K (838mm)	2
<b>UCLED18W3K</b>	230V 18W 3000K (1138mm)	2
<b>UCLED22W3K</b>	230V 22W 3000K (1438mm)	2

Code	Model	Qty
<b>UC250</b>	Link Power Cord 250mm	1
<b>UC500</b>	Link Power Cord 500mm	1
<b>UC1000</b>	Link Power Cord 1000mm	1
<b>UCCUP</b>	Seamless Coupler	5
<b>UCP200</b>	Power Cable 2000mm	1

**Accessories available**

230V

IP  
20

FIXING KIT SUPPLIED

## SLIMLINE FLUORESCENT LIGHTING

This range of Knightsbridge® surface mounted fluorescent fittings are ideal for use under cabinets and illuminating cupboards and wardrobes. They are linkable via direct connection or by link leads (LC1-LC6) individually switched.

### T46A

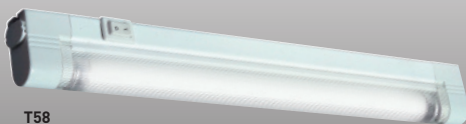

T58

### T4 LINKABLE SLIMLINE FLUORESCENT FITTINGS

**Dimensions:** W: 20mm H: 44mm  
**Lamp:** T4 4000K tubes  
**Construction:** Polycarbonate body and diffuser

Code	Model	Length	Qty
T46A	6W	270mm	1
T410	10W	420mm	1
T416	16W	520mm	1
T420	20W	615mm	1
T425	25W	703mm	1
T430	30W	814mm	1

### T5 LINKABLE SLIMLINE FLUORESCENT FITTINGS

**Dimensions:** W: 23mm H: 42mm  
**Lamp:** T5 3500K tubes  
**Construction:** Polycarbonate body and diffuser

Code	Model	Length	Qty
T56	6W	267mm	1
T58	8W	343mm	1
T514	14W	604mm	1
T521	21W	904mm	1
T528	28W	1204mm	1
T535	35W	1500mm	1

230V

IP  
20



## SLIMLINE FLUORESCENT LIGHTING



### T4 TUBES

Replacement T4 tubes. 4000K

Code	Model	Length	Qty
T46TUBE*	6W	220mm	25
T46ATUBE	6W	232mm	25
T410TUBE	10W	370mm	25
T416TUBE	16W	468mm	25
T420TUBE	20W	565mm	25
T425TUBE	25W	655mm	25
T430TUBE	30W	765mm	25

\* To fit previous T46 model [pre 2013]

### T5 TUBES

Replacement T5 tubes. 3500K

Code	Model	Length	Qty
T56TUBE	6W	225mm	25
T58TUBE	8W	300mm	25
T514TUBE	14W	565mm	25
T521TUBE	21W	862mm	25
T528TUBE	28W	1163mm	20
T535TUBE	35W	1463mm	10

### LINK LEADS

Code	Model	Length	Qty
LC1	T4	280mm	1
LC2	T4	530mm	1
LC3	T4	1030mm	1
LC4	T5	280mm	1
LC5	T5	530mm	1
LC6	T5	1030mm	1



# UNDER CABINET LIGHTING



LTI01C

CRF03CBR

## LEDREC

**Dimensions:** W: 86mm L: 141mm D: 55mm  
**Lamp type:** LED (3W)  
**Driver:** 12VDCA Required Max 3 units per driver

Code	Model	Qty
------	-------	-----

LEDREC	12V DC 3W LED rectangular cabinet light - brushed chrome	1
--------	----------------------------------------------------------	---

LED

## LEDTRI

**Dimensions:** W: 130mm L: 129mm D: 48mm  
**Lamp type:** LED (3W)  
**Driver:** 12VDCA Required Max 3 units per driver

Code	Model	Qty
------	-------	-----

LEDTRI	12V DC 3W LED triangular cabinet light - brushed chrome	1
--------	---------------------------------------------------------	---

LED

## LTI01

**Dimensions:** W: 127mm H: 143mm D: 40mm-3mm  
**Lamp type:** 15 x LEDs (2.1W)  
**Driver:** 12VDCA Max 3 units per driver

Code	Model	Qty
------	-------	-----

LTI01W	White	1
LTI01C	Chrome	1
LTI01CBR	Brushed chrome	1

LED

## CRF03

**Dimensions:** Overall Ø: 72mm Cut out Ø: 60mm  
 Recessed depth: 20mm

**Lamp type:** 15 x LEDs (2.1W)

**Enclosure type:** Enclosed

**Driver:** 12VDCA Max 3 units per driver

**Construction:** Pressed steel

Code	Model	Qty
------	-------	-----

CRF03W	White	1
--------	-------	---

CRF03B	Brass	1
--------	-------	---

CRF03C	Chrome	1
--------	--------	---

CRF03CBR	Brushed chrome	1
----------	----------------	---

LED

12V

IP 20



12V

IP 20



Lamps not included unless otherwise stated

## UNDER CABINET LIGHTING

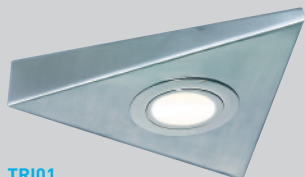

**TRI01**

**Dimensions:** W: 200mm H: 200mm D: 35mm-10mm

**Lamp type:** GX5.3 20W max

**Driver:** 12V 60VA Required - **(Code:T02)**

**Construction:** Pressed steel

Code	Model	Qty
TRI01C	Chrome	1
TRI01CBR	Brushed chrome	1

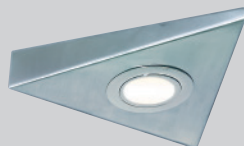

**STI01**

**Dimensions:** W: 127mm H: 143mm D: 40mm-3mm

**Lamp type:** GX5.3 20W max

**Driver:** 12V 60VA Required - **(Code:T02)**

**Construction:** Pressed steel

Code	Model	Qty
STI01W	White	1
STI01C	Chrome	1
STI01CBR	Brushed chrome	1

**CRF02W**



**CRF02CBR CRF02**



**CRF02C**

**CRF02B**

**Dimensions:** Overall Ø: 72mm,  
Cut out Ø: 60mm  
Recessed depth: 20mm

**Lamp type:** G4 12V 10W and 20W max

**Enclosure type:** Enclosed

**Driver:** 12V 60VA Required - **(Code:T02)**

**LED compatible:** Yes

**Construction:** Pressed steel

Code	Model	Qty
CRF02W	White	1
CRF02B	Brass	1
CRF02C	Chrome	1
CRF02CBR	Brushed chrome	1

12V

IP 20



**TRIGX53CBR**

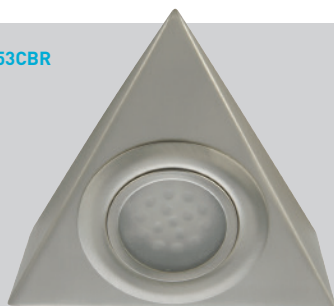

**TRIGX53CBR**

**Dimensions:** W: 175mm H: 175mm D: 43mm-21mm

**Lamp type:** GX53 9W max

**Construction:** Pressed steel

Code	Model	Qty
TRIGX53CBR	Brushed chrome	1

230V

IP 20



**CRFGX53C**



**CRFGX53B**



**Dimensions:** Overall Ø: 96mm  
Cut out Ø: 83mm Recessed depth: 30mm

**Lamp type:** GX53 9W max

**LED compatible:** Yes

**Construction:** Pressed steel

Code	Model	Qty
CRFGX53W	White	1
CRFGX53B	Brass	1
CRFGX53C	Chrome	1
CRFGX53CBR	Brushed chrome	1

Lamps not included unless otherwise stated

# TRIANGULAR AND FLAT LED STRIPLIGHTS



LEDT3WCW



LEDT11WWW



Supplied with

Code	Model	LED1000 Qty
LEDTCLIP	Metal mounting clip for triangular linear striplight	1
LEDTCON	PVC connector for additional triangular linear striplights	1

## TRIANGULAR LED STRIPLIGHTS

**Dimensions:** W: 33mm H: 20mm  
**Lamp:** SMD LEDs  
**Driver:** Required - 36W 24V switching power adapter (Code: LEDADP36)  
**Construction:** Extruded aluminium.

Code	Model	Length	Qty
<b>3W</b> <span style="float: right;"><b>LED</b></span>			
<b>Lamp data:</b>	Lux level: 200 lux at 500mm Beam angle: 90°		
LEDT3WCW	3W cool white 6000K	300mm	1
LEDT3WWW	3W warm white 3000K	300mm	1
<b>5W</b> <span style="float: right;"><b>LED</b></span>			
<b>Lamp data:</b>	Lux level: 300 lux at 500mm Beam angle: 90°		
LEDT5WCW	5W cool white 6000K	500mm	1
LEDT5WWW	5W warm white 3000K	500mm	1
<b>11W</b> <span style="float: right;"><b>LED</b></span>			
<b>Lamp data:</b>	Lux level: 700 lux at 500mm Beam angle: 90°		
LEDT11WCW	11W cool white 6000K	1000mm	1
LEDT11WWW	11W warm white 3000K	1000mm	1

## THIN LINEAR LED STRIPLIGHTS

**Dimensions:** W: 33mm H: 8mm  
**Lamp:** SMD LEDs  
**Driver:** Required - 36W 24V switching power adapter (Code: LEDADP36)  
**Construction:** Extruded aluminium

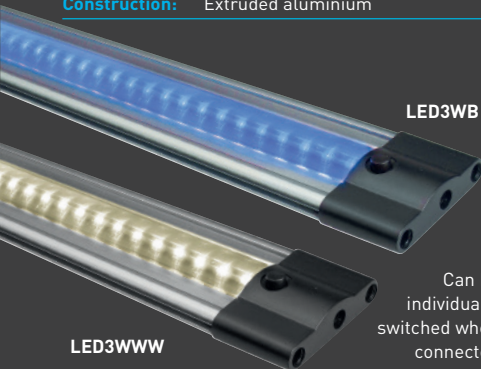

LED3WB

LED3WWW

Can be individually switched when connected

Supplied with

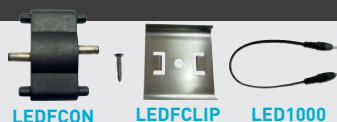

LEDFCON

LEDFCLIP

LED1000

Code	Model	Length	Qty
<b>3W</b> <span style="float: right;"><b>LED</b></span>			
<b>Lamp data:</b>	Lux level: 200 lux at 500mm Beam angle: 90°		
LED3WCW	3W cool white 6000K	300mm	1
LED3WWW	3W warm white 3000K	300mm	1
LED3WB	3W blue	300mm	1
<b>5W</b> <span style="float: right;"><b>LED</b></span>			
<b>Lamp data:</b>	Lux level: 300 lux at 500mm Beam angle: 90°		
LED5WCW	5W cool white 6000K	500mm	1
LED5WWW	5W warm white 3000K	500mm	1
LED5WB	5W blue	500mm	1
<b>11W</b> <span style="float: right;"><b>LED</b></span>			
<b>Lamp data:</b>	Lux level: 700 lux at 500mm Beam angle: 90°		
LED11WCW	11W cool white 6000K	1000mm	1
LED11WWW	11W warm white 3000K	1000mm	1
LED11WB	11W blue	1000mm	1



# LED STRIPLIGHT ACCESSORIES

## TOUCH DIMMER



LEDTD1

## REWIREABLE POWER CONNECTOR



LEDTD2

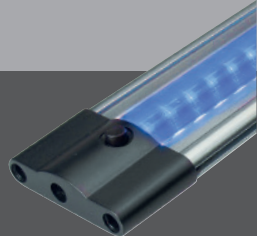

Code	Model	Qty
LEDTD1	IP20 touch dimmer for ultra thin linear LED striplights	1
LEDTD2	DC 24V IP20 plug-in power rewirable connector for ultra thin linear LED striplights	1
LEDFCLIP	Metal mounting clip for ultra thin linear striplights	1
LEDFCON	PVC connector for additional ultra thin linear striplights	1
LEDRACON	PVC right angle connector for ultra thin linear striplights	1

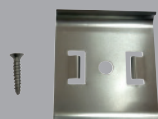

LEDFCLIP



LEDFCON



LEDRACON

## LEDDIMMER



LED8SPLIT



LEDADP36

LED100

Code	Model	Qty
LEDDIMMER	Electronic dimmer with memory function. L: 70mm W: 25mm D: 12mm	1
LEDADP36	36W 24V switching power adapter. L: 95mm W: 43mm D: 28mm	1
LED8SPLIT	PVC DC 8 way splitter	1

Code	Model	Qty
LED100	100mm power lead to connect additional linear striplights	1
LED250	250mm power lead to connect additional linear striplights	1
LED1000	1000mm power lead to connect additional linear striplights	1
LED2500	2500mm power lead to connect additional linear striplights	1

24V

IP 20



# 24V RGB LED FLEX LIGHTING

LED24RGB



## RGBCON

RGB infrared remote control unit for use with **LED24RGB**. Will control up 144W. Full range of lighting controls at your fingertips including colour change modes, speeds and variations.

A separate control unit is required for each circuit.

Code	Model	Qty
RGBCON	RGB infrared remote control	1



## RGBCON

## RGB COLOUR CHANGE LED FLEX

**LED**

**Dimensions:** W: 10mm H: 2.5mm

**Lamp:** 60 x 35/28 LEDs per m (7.2W per m)

**Driver:** Constant voltage [Code: 24DC100]

**Construction:** 24V LED flex c/w 3M™ self-adhesive tape

Code	Model	Length	Qty
LED24RGB	24V IP20 colour changing RGB flex	3m	1



30 super bright 50/50 LEDs per metre. Can be cut as required to a minimum length of 3cm. Requires 24V DC LED Driver. Runs cool to touch, low voltage, safe to handle. IP20. Fully controllable via **RGBCON** remote control unit (not included).

24V

IP  
20



# SINGLE COLOUR LED FLEX LIGHTING



## WHAT IS LED FLEX?

LED Flex is a versatile, flexible LED light strip which can be cut at 50mm (2 inch) intervals. Off-cuts can be reconnected and used elsewhere.

LED Flex is safe, low voltage, energy efficient and draws just 4.8W of power per metre. This power consumption gives it a low working and cool to touch temperature.

Its thin profile and narrow width make it ideal for applications where fluorescent or halogen lights would be too bulky or consume too much power.

3M™ self-adhesive backing is pre-fitted to LED flex making it easy to install in areas such as pelmets, under cabinets, shelving areas and for use as mood/ambient lighting.

## 12V IP20 LED FLEX LIGHTS

LED







**Dimensions:** W: 8mm H: 2mm

**Lamp:** 60 x 35/28 LEDs per m (4.8W per m)

**Driver:** Required 2m: 12V constant voltage  
(Code: 12VDCA)

5m: 12V constant voltage  
(Code: 36VDCA)

**Construction:** 12V LED flex c/w 3M™ self-adhesive tape

Code	Model	Length	Qty
 LEDF212CW	12V cool white 6000K	2m	1
 LEDF212WW	12V warm white 3000K	2m	1
 LEDF212B	12V blue	2m	1
 LEDF12CW	12V cool white 6000K	5m	1
 LEDF12WW	12V warm white 3000K	5m	1
 LEDF12B	12V blue	5m	1
 LEDF12G	12V green	5m	1
 LEDF12R	12V red	5m	1
LEDF12Y	12V yellow	5m	1

## 12V IP67 LED FLEX LIGHTS

LED

**Dimensions:** W: 13mm H: 6mm

**Lamp:** 60 x 35/28 LEDs per m (4.8W per m)

**Driver:** Required 5m: constant voltage (Code: 12DCIP36)

**Construction:** 12V LED flex c/w 3M™ self-adhesive tape

Code	Model	Length	Qty
LEDF12IPCW	12V IP67 cool white 6000K	5m	1
LEDF12IPWW	12V IP67 warm white 3000K	5m	1
LEDF12IPB	12V IP67 blue	5m	1



12V

IP 67



## 24V IP20 LED FLEX LIGHTS

LED

**Dimensions:** W: 8mm H: 2mm

**Lamp:** 60 x 35/28 LEDs per m (4.8W per m)

**Driver:** Required 20m: constant voltage (Code: 24DC100)

**Construction:** 24V LED flex c/w 3M™ self-adhesive tape

Code	Model	Length	Qty
LEDF24CW	24V cool white 6000K	20m	1
LEDF24WW	24V warm white 3000K	20m	1
LEDF24B	24V blue	20m	1

12V

IP 20



24V

IP 20



# LED FLEX LIGHTING ACCESSORIES



## LED FLEX LIGHTING ACCESSORIES

Code	Model	Qty
<b>FLEXCON</b>	Power connector for 12/24V LED flex	1
<b>CENCON</b>	Central butt connector for 12/24V LED flex	1
<b>CENCONF</b>	150mm central flexible connector for 12/24V LED flex.	1
<b>CONIP</b>	Connector kit for 12V IP67 LED flex Pack includes 1 male, 1 female flex connector and 4 x IP67 end caps	1
<b>CENCONS</b>	Flexible end power connector for 12/24V LED flex	1

## FIXING KIT

<b>FLEXFIX</b>	Fixing kit for IP67 LED flex (5 clips per pack)	1
----------------	-------------------------------------------------	---

## 12V CONSTANT VOLTAGE DC DRIVERS

<b>12DC36</b>	12V 36W IP20 DC driver	1
<b>12DCIP36</b>	12V 36W IP67 DC driver	1
<b>12VDCA</b>	12V 12W IP20 DC driver	1
<b>36VDCA</b>	12V 36W IP20 DC driver	1

## 24V CONSTANT VOLTAGE DRIVERS

Code	Model	Qty
<b>24DC100</b>	24V 100W IP20 DC driver	1
<b>24DC150</b>	24V 150W IP20 DC driver	1
<b>24VDCA</b>	24V 12W IP20 DC driver	1

## RGB LED FLEX AMPLIFIER

RGB amplifier DC 24V. Max power 144W  
For use with larger systems

<b>RGBAMP</b>	DC 24V RGB amplifier	1
---------------	----------------------	---

## RGB CONNECTORS

RGB connectors for connecting RGB flex to RGB controller.

<b>RGBFCON</b>	RGB inline connector	1
<b>RGBFLEX</b>	150mm RGB flexible connector	1

## 24V RGB COLOUR CHANGE LED FLEX ACCESSORIES IP20 DC MALE POWER CONNECTOR.-

For use in connecting 24V DC power to RGB control unit (RGBCON)

<b>CONDC</b>	RGB inline connector	1
--------------	----------------------	---

# DISPLAY LIGHTING



CT3525C

CT3402C



CT3522C

## STRAIGHT ARM PICTURE LIGHT

**Dimensions:** Base Ø: 55mm D: 5mm

**Straight arm:** H: 96mm L: 450mm

**Lamp type:** MR16 35W max

**Driver:** 12V 60VA Required - **(Code:T02)**

**LED compatible:** Yes

**Construction:** Chrome plated steel

Code	Model	Qty
CT3525C	Chrome (straight arm)	1

## CURVED ARM PICTURE LIGHT

**Dimensions:** Base Ø: 47mm D: 50mm

**Curved arm:** H: 96mm L: 450mm **Tilt angle:** 180°

**Lamp type:** MR16 35W max

**Driver:** 12V 60VA Required - **(Code:T02)**

**LED compatible:** Yes

**Construction:** Plated steel

Code	Model	Qty
CT3402C	Chrome (curved arm)	1
CT3402BC	Brushed chrome (curved arm)	1

## DISPLAY SPOTLIGHT

**Dimensions:** Base: Ø55mm D: 5mm Arm: 100mm

**Lamp type:** MR16 35W max

**Driver:** 12V 60VA Required - **(Code:T02)**

**LED compatible:** Yes

**Construction:** Chrome plated steel

Code	Model	Qty
CT3522C	35W display spotlight	1

12V

IP  
20



Lamps not included unless otherwise stated



## Brilliant service,

staff are always very quick to respond to any problems or requests.

ML Accessories always go the extra mile with customer service and their products are without doubt at the

## cutting edge

of what's needed now and for tomorrow.

MLA are the "go to" company for any information regarding electrical goods. We always get an

## immediate response and first class customer service.

One of the **most efficient** companies I have worked with in over 20 years in the business



## ML Accessories are a class apart!

**Brilliant service and great communication.**

**A delightful company to work with.**

## ML Accessories are a fantastic company to deal with

on every level great people, great products and great service. Would highly recommend.

The staff are always polite with a happy manner and spot on technical knowledge, extremely helpful company with

Working with MLA is a breath of fresh air, nothing is too much trouble for them. They have an incredible and constantly growing range of products, their stock levels are exceptional and their

**service is second to none.**

If only all suppliers were this good.

## 10/10 service

VISION  
PROCESS  
CUSTOMER  
INDUSTRY  
ADVERTISING  
WAREHOUSE  
MANAGEMENT  
QUALITY  
ACTION  
SUCCESS  
TARGET  
CUSTOMER  
SERVICES  
AFTERSALES  
FULFILMENT  
DEVELOPMENT  
INNOVATION  
DATA  
EMBRACING  
TECHNOLOGY

**Knightsbridge**<sup>®</sup>  
the mark of quality

**2,500 PRODUCTS**

DATA  
STRATEGY  
INDUSTRY  
TARGET  
CREATIVITY  
JOBS  
MARKET  
INSIGHT  
TRAINING  
DEVELOPMENT  
NATIONAL SALES  
AND ACCOUNT  
MANAGEMENT  
CAREERS  
MANAGEMENT  
JOB  
PLAN  
PROMOTION  
PRODUCT  
DEVELOPMENT  
STRATEGY  
BUSINESS  
VISION  
INDUSTRY  
TARGET



**Switch ON**

to one of the UK's fastest growing businesses



P160

### Section Index

Track Spotlights	154-155
Decorative Spotlights	156-158
LED Recessed Wall Lighting	159
Wall/Ceiling Lights	160

# TRACK SPOTLIGHTS



**TRKSP1BC**  
Shown with GUC0B7WW  
LED lamp (not included)

## TRACK SPOTLIGHTS

Code	Model	Finish	Qty
TRKSP1BC	Square spotlight	satin nickel	1
TRKSP2BC	Round spotlight	satin nickel	1
TRKSP3BC	Slotted spotlight	satin nickel	1
TRKSP4BC	Bullet spotlight	satin nickel	1
TRKSP1BK	Square spotlight	black	1
TRKSP2BK	Round spotlight	black	1
TRKSP3BK	Slotted spotlight	black	1
TRKSP4BK	Bullet spotlight	black	1
TRKSP1W	Square spotlight	white	1
TRKSP2W	Round spotlight	white	1
TRKSP3W	Slotted spotlight	white	1
TRKSP4W	Bullet spotlight	white	1





## 230V SINGLE CIRCUIT TRACK

Code	Length	Finish	Qty
TRK1MS	1m	satın nickel	1
TRK1MW	1m	white	1
TRK1MBK	1m	black	1
TRK2MS	2m	satın nickel	1
TRK2MW	2m	white	1
TRK2MBK	2m	black	1
TRK3MS	3m	satın nickel	1
TRK3MW	3m	white	1
TRK3MBK	3m	black	1

## 230V SINGLE CIRCUIT TRACK ACCESSORIES

Code	Model	Finish	Qty
TRKCS	Track connector	satın nickel	1
TRKCW	Track connector	white	1
TRKCBK	Track connector	black	1
TRKDES	Dead end cap	satın nickel	1
TRKDEW	Dead end cap	white	1
TRKDEBK	Dead end cap	black	1
TRKFCS	Flexible connector	satın nickel	1
TRKFCW	Flexible connector	white	1
TRKFCBK	Flexible connector	black	1
TRKLCS	In-line connector	satın nickel	1
TRKLCW	In-line connector	white	1
TRKLCBK	In-line connector	black	1
TRKPFCS	Power feed	satın nickel	1
TRKPFW	Power feed	white	1
TRKPFBK	Power feed	black	1
TRKRAS	Right angle connector	satın nickel	1
TRKRAW	Right angle connector	white	1
TRKRABK	Right angle connector	black	1
TRKTS	T-connector	satın nickel	1
TRKTW	T-connector	white	1
TRKTBK	T-connector	black	1
TRKXS	Connector-X	satın nickel	1
TRKXW	Connector-X	white	1
TRKXBK	Connector-X	black	1



TRKCS Track connector



TRKDES Dead end cap



TRKFCS Flexible connector

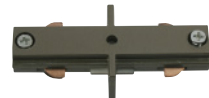

TRKLCS In-line connector



TRKPFCS Power feed



TRKRAS Right angle connector



TRKTS T-connector



TRKXS Connector-X

## DECORATIVE SPOTLIGHTS

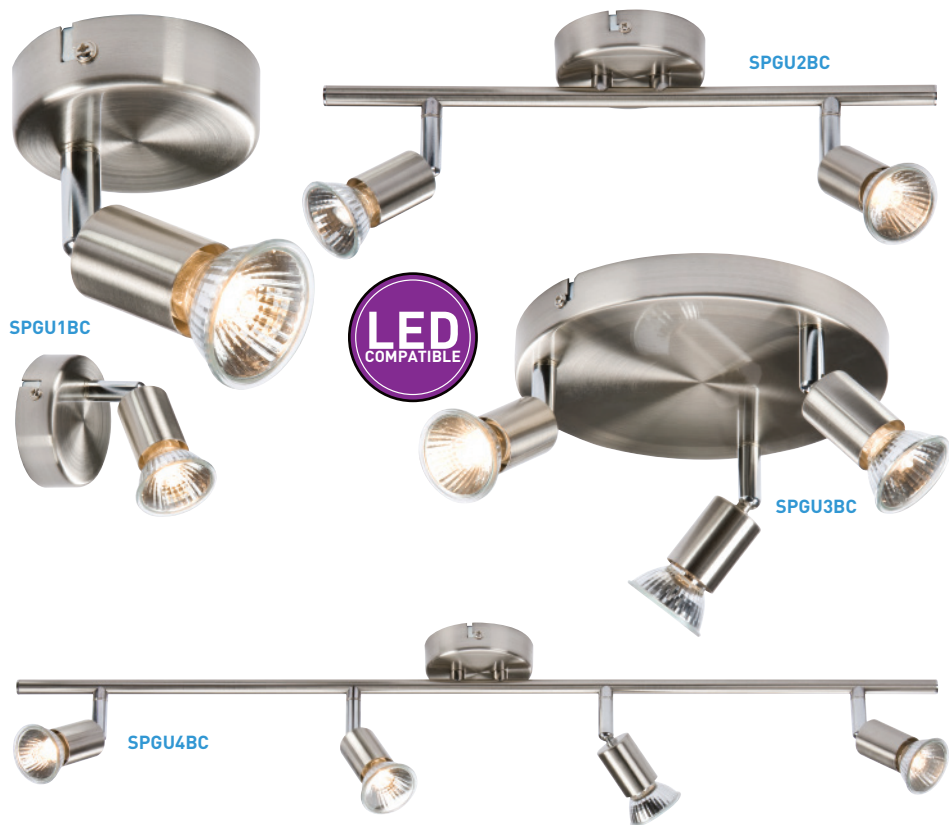

A range of brushed chrome ceiling/wall spotlights **supplied with GU10 halogen lamps**.  
The range can also be used with LED GU10 compatible lamps (retrofit size only)  
Suitable for ceiling or wall mounting.

### SPGU1BC

**Dimensions:** Base Ø: 80mm  
Height from base at 90°: 35mm  
**Lamp:** 1 x GU10 50W max - **supplied**

Code	Model	Qty
SPGU1BC	Brushed chrome single spot	1

### SPGU3BC

**Dimensions:** Base Ø: 200mm  
Height from base at 90°: 35mm  
**Lamp:** 3 x GU10 50W max - **supplied**

Code	Model	Qty
SPGU3BC	Brushed chrome triple spot	1

### SPGU2BC

**Dimensions:** Base Ø: 90mm W: 360mm  
Height from base at 90°: 35mm  
**Lamp:** 2 x GU10 50W max - **supplied**

Code	Model	Qty
SPGU2BC	Brushed chrome double spot	1

### SPGU4BC

**Dimensions:** Base Ø: 90mm W: 760mm  
Height from base at 90°: 35mm  
**Lamp:** 4 x GU10 50W max - **supplied**

Code	Model	Qty
SPGU4BC	Brushed chrome quad spot	1





Our stylish decorative spotlights are supplied complete with GU10 35W halogen lamps. These new contemporary surface spotlights are ideal in most domestic, retail or commercial applications.

The single unit can be mounted on walls making a perfect bedside reading light. Each head is fully adjustable with tilt facility. The range can also be used with LED GU10 compatible lamps (retrofit size only). Finished in polished bright chrome, this range is the perfect choice for most indoor environments.

## SP1C

**Dimensions:** Base: 120mm x 80mm  
Height from base at 90°: 117mm  
**Lamp:** 1 x GU10 35W max - **supplied**

Code	Model	Qty
SP1C	Chrome single spot	1

## SP3C

**Dimensions:** Base: 120mm x 80mm W: 500mm  
Height from base at 90°: 117mm  
**Lamp:** 3 x GU10 35W max - **supplied**

Code	Model	Qty
SP3C	Chrome triple ceiling spot	1

## SP4C

**Dimensions:** Base: 120mm x 80mm W: 640mm  
Height from base at 90°: 117mm  
**Lamp:** 4 x GU10 35W max - **supplied**

Code	Model	Qty
SP4C	Chrome quad ceiling spot	1



## DECORATIVE SPOTLIGHTS



AL131BC



AL132BC



AL133BC



A range of brushed chrome ceiling spotlights. The range can also be used with LED GU10 compatible lamps (retrofit size only) Suitable for ceiling or wall mounting.

### AL131BC

**Dimensions:** Base Ø: 85mm  
Height from base at 90°: 35mm  
**Lamp:** 1 x GU10 50W max

Code	Model	Qty
------	-------	-----

AL131BC	Brushed chrome single ceiling spot	1
---------	------------------------------------	---

### AL132BC

**Dimensions:** Base Ø: 195mm  
Height from base at 90°: 35mm  
**Lamp:** 2 x GU10 50W max

Code	Model	Qty
------	-------	-----

AL132BC	Brushed chrome double ceiling spot	1
---------	------------------------------------	---

### AL133BC

**Dimensions:** Base Ø: 225mm  
Height from base at 90°: 35mm  
**Lamp:** 3 x GU10 50W max

Code	Model	Qty
------	-------	-----

AL133BC	Brushed chrome triple ceiling spot	1
---------	------------------------------------	---



Lamps not included unless otherwise stated



## LED RECESSED WALL LIGHTING



NH023W



NH023B



NH025W

Recessed LED guide light complete with integral driver. Manufactured to fit a standard 47mm recessed back box (not supplied). Ideal for stairways and corridors. Low level guide lighting creates a soft ambient glow. Brushed chrome finish. For indoor use only.

### RECESSED LED WALL LIGHTS

LED

**Dimensions:** L: 80mm H: 80mm

**Lamp:** 1W high power LED (non-replaceable)

Code	Model	Qty
NH023W	White LED	1
NH023B	Blue LED	1
NH025W	White LED	1



230V  
50Hz

IP  
20



## WALL/CEILING LIGHTS



**NH0183BD**

### NH0183BD

**Dimensions:** Overall Ø: 60mm H: 160mm D: 90mm

**Lamp:** 2 x GU10 35W max

The product can also be used with LED GU10 compatible lamps (retrofit size only)

Code	Model	Qty
------	-------	-----

NH0183BD	Stainless steel up and down wall light	1
----------	----------------------------------------	---

230V  
50Hz

IP  
20



**NH0184SQ**

### NH0184SQ

**Dimensions:** H: 160mm W: 60mm D: 100mm

**Lamp:** 2 x GU10 35W max

The product can also be used with LED GU10 compatible lamps (retrofit size only)

Code	Model	Qty
------	-------	-----

NH0184SQ	Stainless steel up and down wall light	1
----------	----------------------------------------	---

230V  
50Hz

IP  
20



**Section Index**

LED Bathroom Mirrors	163
LED Bathroom Mirrors and Shaver Lights	164
Bathroom Mirrors	165-166
Bathroom Downlights	167-168



P164

# REGULATIONS GUIDE

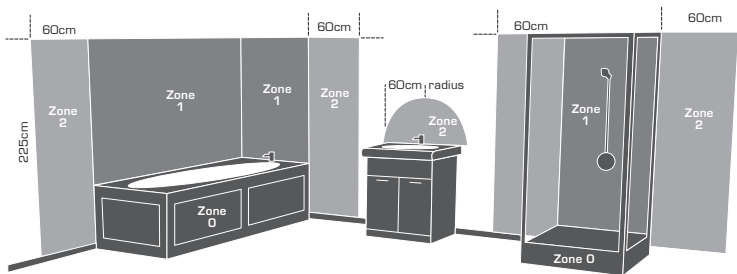

**Bathroom luminaire installations must comply with legislation. This has recently been updated and is now Section 701 of BS7671:2008 (Wiring Regulations 17th Edition)**

## Bathroom Zones

**Zone 0** is inside the bath or shower itself. Any fitting used in this zone must be IP68 low voltage (max 12V).

**Zone 1** is the area above the bath to a height of 2.25m from the floor. In this zone a minimum rating of IP44 is required. If the fitting is 240v a 30mA residual current device (RCD) must also be used to protect the circuit in this zone.

**Zone 2** is an area stretching 0.6m outside the perimeter of the bath and to a height of 2.25m from the floor. In this zone an IP rating of at least IP44 is required. In addition, it is good practice to consider the area around a wash basin (within a 60cm radius of any tap) as Zone 2.

**Outside zones** is anywhere outside zones 0, 1 and 2 (subject to specific limits) and where no water jet is likely to be used. No IP rating is required.

In addition to the above, if there is a likelihood of water jets being used for cleaning purposes in zones 1, 2 and "Outside Zones" a fitting rated a minimum IP65 must be used.

Full details can be found in the latest copy of IEE wiring regulations.

## IP RATING GUIDE

# IP44

**Solid Object**

**Moisture**

1

Protection against solid objects greater than 50mm in diameter.

2

Protection against objects no greater than 80mm in length and 12mm in diameter.

3

Protected against a solid object greater than 2.5mm such as tools.

4

Protected against a solid object greater than 1mm such as a wire.

5

Protection from the amount of dust that would interfere with the operation of the equipment.

6

Dust tight. No ingress of dust.

1

Protection from drops of water. Limited ingress permitted.

2

Protected against vertical falling dripping water. Limited ingress permitted.

3

Protected against sprays of water up to 60 degrees. Limited ingress permitted.

4

Protected against splashes of water. Limited ingress permitted.

5

Protection from water projected from a nozzle.

6

Protected against powerful jets of water. Limited ingress permitted.

7

Watertight against the effects of immersion in water.

8

Watertight against the effects of immersion in water under pressure for long periods.

## LED BATHROOM MIRRORS



### RCTM2LED

IP21 shaver socket works independently from the light.



### RCTM2LED

LED

**Dimensions:** Metal base: W: 370mm H: 490mm

Glass mirror: W: 390mm H: 500mm D: 50mm

**Lamp type:** 12W LED (non-replaceable)

**Colour temp:** 4000K cool white

**Driver:** Internal

**Construction:** Pressed steel and glass.

Shaver socket works independently from the light.

Pull cord switch fitted for independent light switching.

Shaver socket is IP21. All fixings included.

Code	Model	Qty
------	-------	-----

RCTM2LED	LED bathroom mirror with dual voltage shaver socket	1
----------	-----------------------------------------------------	---

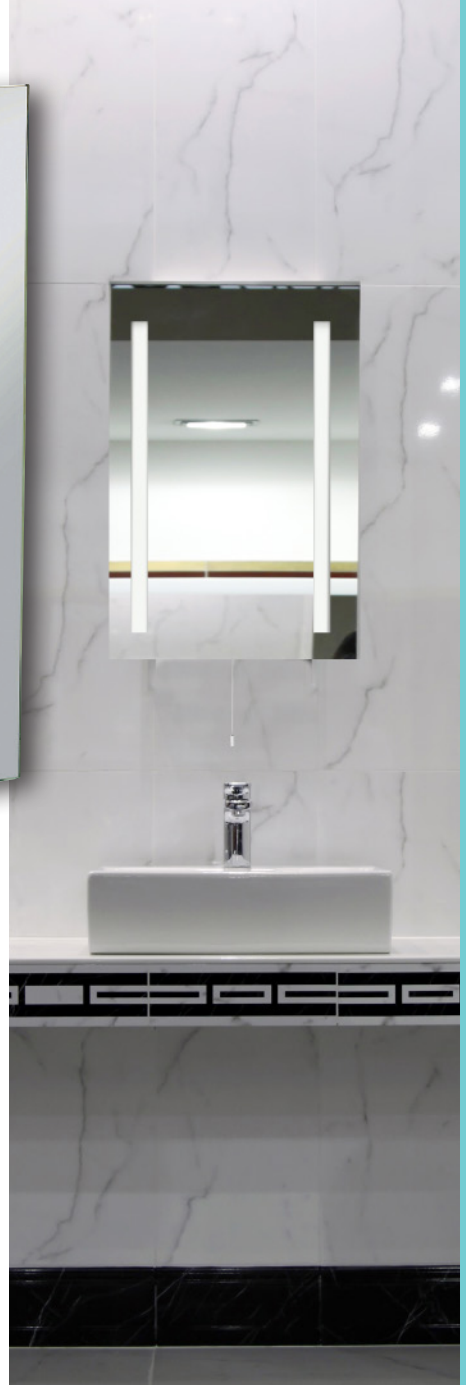

230V  
50Hz

IP  
44

IP21  
Shaver  
Socket



# LED BATHROOM MIRRORS AND SHAVER LIGHT

RCT5048

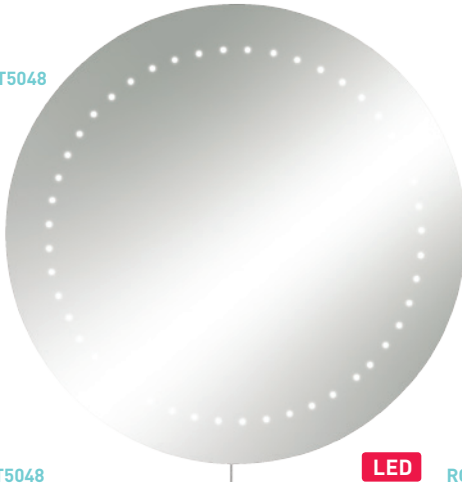

RCT5048

LED

**Dimensions:** Metal base: Ø 480mm  
Glass mirror Ø: 500mm D: 36mm  
**Lamp type:** 12W LED (non-replaceable)  
**Colour temp:** 4000K cool white  
**Driver:** Internal  
**Construction:** Pressed steel and glass

Code	Model	Qty
RCT5048	Round mirror	1

RCT5039



RCT5039

LED

**Dimensions:** Metal base: W: 350mm H: 430mm  
Glass mirror: W: 390mm H: 500mm D: 50mm  
**Lamp type:** 12W LED (non-replaceable)  
**Colour temp:** 4000K cool white  
**Driver:** Internal  
**Construction:** Pressed steel and glass

Code	Model	Qty
RCT5039	Rectangular mirror	1

230V  
50Hz

IP  
44



## SHAVER LIGHT



SLIGHT

SLIGHT

**Dimensions:** L: 490mm W: 60mm D: 70mm  
**Lamp type:** 284mm S15 60W - **supplied**  
**Construction:** Polycarbonate body and diffuser

Code	Model	Qty
SLIGHT	Dual voltage 115V - 230V with shaver socket	1

230V  
50Hz

IP  
20

IP21  
Shaver  
Socket





IP21 shaver socket works independently from the light.



**RCTM2T8**

**Dimensions:** Metal base: W: 370mm H: 490mm

Glass mirror: W: 390mm H: 500mm D: 50mm

**Lamp type:** 2 x 15W T8 (450mm) - **supplied**

**Colour temp:** 4000K cool white

**Control gear:** HF soft start

**Construction:** Pressed steel and glass.

Shaver socket works independently from the light.

Pull cord switch fitted for independent light switching.

Shaver socket is IP21. All fixings included.

Code	Model	Qty
RCTM2T8	Rectangular mirror with dual voltage shaver socket	1

230V 50Hz
IP 44
IP21 Shaver Socket
⏏
⚡



# BATHROOM MIRRORS



RCT6045



RCT6070SD

Shaver socket works independently from the light. Pull cord switch fitted for independent light switching. All fixings included. Demister heat pad fitted to back of mirror (**RCT6045SD** and **RCT6070SD** only).

## RCT6045

**Dimensions:** Metal base: W: 425mm H: 570mm

Glass mirror: W: 450mm H: 600mm D: 50mm

**Lamp type:** 2 x 13W T5 - **supplied**

**Colour temp:** 4000K cool white

**Control gear:** HF soft start

**Construction:** Pressed steel and glass

Code	Model	Qty
<b>RCT6045</b>	Rectangular mirror	1
<b>RCT6045SD</b>	Rectangular mirror with demister pad and dual voltage shaver socket	1

## RCT6070

**Dimensions:** Metal base: W: 575mm H: 650mm

Glass mirror: W: 600mm H: 700mm D: 50mm

**Lamp type:** 2 x 13W T5 - **supplied**

**Colour temp:** 4000K cool white

**Control gear:** HF soft start

**Construction:** Pressed steel and glass

Code	Model	Qty
<b>RCT6070S</b>	Rectangular mirror with dual voltage shaver socket	1
<b>RCT6070SD</b>	Rectangular mirror with demister pad and dual voltage shaver socket	1





## BATHROOM DOWNLIGHTS



CH15GUSF



CH15GUSCL



CH14GURF



CH14GURCL

### CH15GU

**Dimensions:** L 90mm x W 90mm Dome lens Ø: 65mm  
Cut out Ø: 70mm Recessed depth: 75mm

**Lamp type:** GU10 50W max **Lamp fixing:** Spring clip  
**Enclosure type:** Open **LED compatible:** Yes

**Construction:** Press steel /glass. Complete with bridge and lampholder

Code	Model	Qty
CH15GUSCL	Clear glass chrome rim downlight	1
CH15GUSF	Frosted glass downlight	1

### CH14UR

**Dimensions:** Overall Ø: 100mm Dome lens Ø: 65mm  
Cut out Ø: 70mm Recessed depth: 75mm

**Lamp type:** GU10 50W max **Lamp fixing:** Spring clip  
**Enclosure type:** Open **LED compatible:** Yes

**Construction:** Press steel /glass. Complete with bridge and lampholder

Code	Model	Qty
CH14GURCL	Clear glass chrome rim downlight	1
CH14GURF	Frosted glass downlight	1

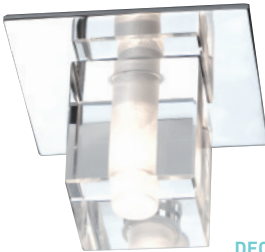

DEC1234C

### DEC1234C

**Dimensions:** Overall: W: 75mm H: 75mm  
Crystal body: 40mm 40mm Cut out Ø: 55mm  
Recessed depth: 80mm

**Lamp type:** G4 20W max - **supplied**  
**Enclosure type:** Open

**Transformer:** 12V 60VA required - **(Code:T02)**

**Construction:** Die-cast aluminium / glass. Complete with bridge and lampholder

Code	Model	Qty
DEC1234C	Square crystal shower downlight	1



DEC1233C

### DEC1233C

**Dimensions:** Overall Ø: 75mm  
Crystal body Ø: 50mm Cut out Ø: 55mm  
Recessed depth: 80mm

**Lamp type:** G4 20W max- **supplied**  
**Enclosure type:** Open

**Transformer:** 12V 60VA required - **(Code:T02)**

**Construction:** Die-cast aluminium / glass. Complete with bridge and lampholder

Code	Model	Qty
DEC1233C	Round crystal shower downlight	1



Lamps not included unless otherwise stated

# BATHROOM DOWNLIGHTS



RDSHCBR



RDSHW



RDSHC

## RDSH

**Dimensions:** Overall Ø: 88mm Cut out Ø: 72mm

Recessed depth: 135mm

**Lamp type:** MR16 35W max **Lamp fixing:** Spring clip

**Enclosure type:** Open

**Transformer:** 12V 60VA required - **(Code:T02)**

**LED compatible:** Yes

**Construction:** Die-cast aluminium. Complete with bridge and lampholder

Code	Model	Qty
RDSHW	White shower downlight	1
RDSHC	Chrome shower downlight	1
RDSHCBR	Brushed chrome shower downlight	1

12V

IP  
65



Lamps not included unless otherwise stated

**Section Index**

High Output LED Downlights	170
HF Fluorescent Downlights	171
LED Recessed Modular Fittings	172-173
HF Recessed Modular T5 Fluorescent Fittings	174
HF Recessed Modular T8 Fluorescent Fittings	175
HF Recessed Modular PL Fluorescent Fittings	176
HF Surface Modular Fluorescent Fittings	177
HF Surface/Suspended Fluorescent Fittings	178-179
LED Linear Battens and Accessories	180
Suspended Luminaires	181
T8 HF Fluorescent Battens	182
T8 LED Ready Battens and Tubes	183
T5 HF Fluorescent Battens	184
LED Battens	185
LED Non-Corrosive Fluorescent	186
T8 HF Non-Corrosive Fluorescent	187
T5 HF Non-Corrosive Fluorescent	188
110V T8 Non-Corrosive Fluorescent	189

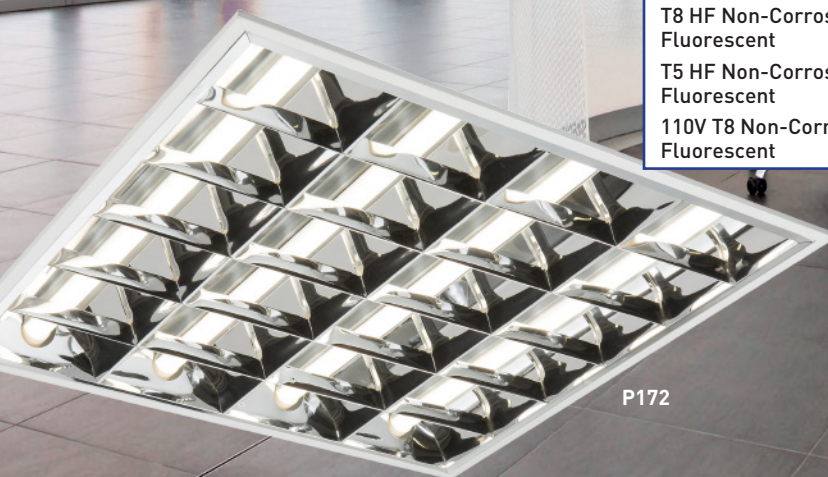

P172

# HIGH OUTPUT LED DOWNLIGHTS



PL18LED and PL23LED are fitted with non-slip safety clips



PL23LED



PLD23W

**Emergency Option PL23LED ONLY.**  
Converts into a 3 hour emergency maintained luminaire by using **EMKIT**

## PL18LED

LED

**Dimensions:** Overall Ø: 230mm D: 70mm Cut out Ø: 220mm

**Lamp type:** 18W (non-replaceable)  
Samsung SMD LED

**Lamp data:** 1550lm 4000K 30,000 hours

**Control gear:** Remote constant current driver - **Supplied**

**Construction:** Aluminium chassis with opal polycarbonate diffuser. Twin spring clips

Code	Model	Qty
PL18LED	18W Recessed LED luminaire	1

## PL23LED

LED

**Dimensions:** Overall Ø: 230mm D: 70mm Cut out Ø: 220mm

**Lamp type:** 23W (non-replaceable)  
Samsung SMD LED

**Lamp data:** 2150lm 4000K 30,000 hours

**Control gear:** Remote constant current driver - **Supplied**

**Construction:** Aluminium chassis with opal polycarbonate diffuser. Twin spring clips. Dimmable with optional **PLD23W** driver

Code	Model	Qty
PL23LED	23W Recessed LED luminaire	1
PLD23W	Dimmable driver	1



PLED5W



PLED9W

## PLED5W

LED

**Dimensions:** Overall Ø: 140mm D: 24mm Cut out Ø: 125mm

**Lamp type:** 5W (non-replaceable LED)

**Lamp data:** 300lm 4000K 30,000 hours

**Construction:** Polycarbonate chassis with opal polycarbonate diffuser. Twin spring clips

Code	Model	Qty
PLED5W	5W Recessed LED luminaire	1

## PLED9W

LED

**Dimensions:** Overall Ø: 180mm D: 24mm Cut out Ø: 165mm

**Lamp type:** 9W (non-replaceable LED)

**Lamp data:** 590lm 4000K 30,000 hours

**Construction:** Polycarbonate chassis with opal polycarbonate diffuser. Twin spring clips

Code	Model	Qty
PLED9W	9W Recessed LED luminaire	1



# HF FLUORESCENT DOWNLIGHTS



Extremely lightweight polycarbonate body c/w high-end aluminium reflector for optimum light output. This compact fluorescent recessed luminaire is complete with a remote gear tray connected by flex for ease of installation and mounting. Supplied as standard with electronic HF soft start ballast for modern switch gear and is pre-flexed with 200mm of 3 core mains cable.

## HF FLUORESCENT DOWNLIGHTS

**Dimensions:** Overall Ø: 230mm H: 130mm

Cut out Ø: 205mm

**Lamp type:** PL 4P

**Control gear:** HF soft start

**Construction:** Polycarbonate chassis c/w polished aluminium reflector. Supplied with 2m of flex.

**Emergency option:** A simple click-and-go emergency conversion kit enables the gear pack to be exchanged in a matter of seconds and ready for 3hour maintained or non-maintained use.

Code	Model	Qty
PLD118	1 x 18W HF downlight	1
PLD126	1 x 26W HF downlight	1
PLD218	2 x 18W HF downlight	1
PLD226	2 x 26W HF downlight	1
PLD218EM	2 x 18W emergency conversion kit	1
PLD226EM	2 x 26W emergency conversion kit	1
PLDDGM	Frosted drop glass accessory	1
PLDIPCG	Clear glass trim accessory IP40	1
PLDIPMG	Sanded glass trim accessory IP40	1

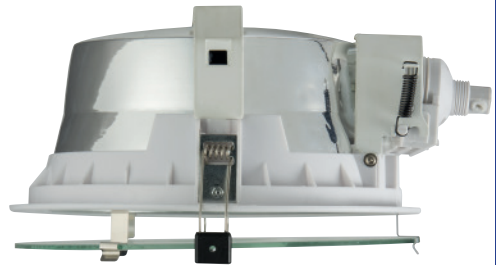

230V  
50Hz

IP  
20



Lamps not included unless otherwise stated

# LED RECESSED MODULAR FITTINGS



## MRBLED / MRBLED6

Recessed LED Module Cat 2. Supplied complete with integrated LED light source. An ideal alternative to standard 4x18W fluorescent modular fittings. Long life, low maintenance. Fits all standard 15mm and 25mm ceiling grids.

Instant ignition, ideal for external sensors, available in both 4000K cool white and 6000K daylight. 3 year warranty. Non-dimmable.

Emergency conversion kit available: EMKIT (not included)

## EMKIT CONVERTER

**Dimensions:** L: 218mm W: 105mm D: 44mm

**Construction:** LED 3 hour emergency kit. Converts most constant current LED luminaires to 3 hour emergency - 36V 50W max. Pre-wired for quick installation. Adaptor leads included. Compatible for maintained or non-maintained use.

## MRBLED

LED

**Dimensions:** L: 595mm W: 595mm D: 52mm

**Lamp type:** LED

**Control gear:** Constant current driver

**Construction:** Steel, aluminium

Suitable for 600mm x 600mm grid ceilings.

**Emergency option:** Available with EMKIT

Code	Model	Qty
MRBLED	40W 4000K	1
MRBLED6	32W 6000K	1

Code	Model	Qty
EMKIT	Pre-wired LED 3 hour Emergency kit.	1

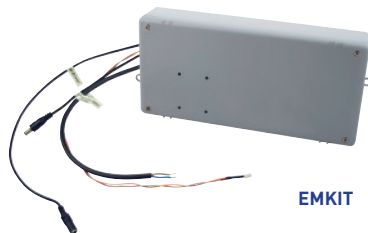

EMKIT

**Emergency Option:** Convert MRBLED into a 3 hour emergency maintained luminaire by using EMKIT



Suitable for 600mm x 600mm grid ceilings

LOOK AND FEEL OF A  
TRADITIONAL T5 MODULAR

LEDMRC



LEDMRC

LED

**Dimensions:** L: 595mm W: 595mm D:45mm**Lamp type:** 4 x 10.5W SMD LED  
(non-replaceable)**Lamp data:** 3300lm 4000K LED**Driver:** Remote constant current  
non-dimmable driver - **supplied****Construction:** polycarbonate

Code	Model	Qty
------	-------	-----

LEDMRC	42W LED panel	1
--------	---------------	---

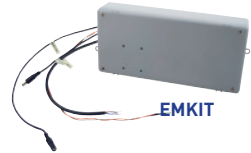

EMKIT

230V  
50HzIP  
20

**Emergency Option:** Convert LEDMRC into a 3 hour emergency maintained luminaire by using **EMKIT**

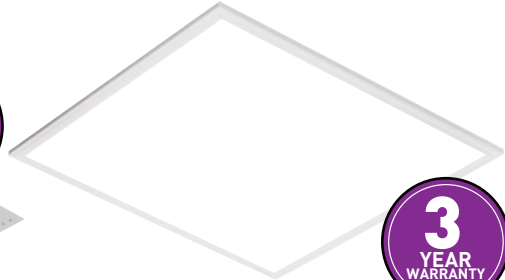

LEDPAN2

LED

**Dimensions:** L: 595mm W: 595mm D:30mm**Lamp type:** 3 x 12W SMD LED strips**Lamp data:** 3000lm 4200K LED**Driver:** Remote constant current  
1A 28V-46V driver - **supplied****Construction:** Powder-coated pressed steel.  
3 x polycarbonate diffuser

Code	Model	Qty
------	-------	-----

LEDPAN2	36W LED panel	1
---------	---------------	---

LEDPAN3

LED

**Dimensions:** L: 595mm W: 595mm D:9.6mm**Lamp type:** 42W (non-replaceable LED)**Lamp data:** 4000lm 4200K LED**Driver:** constant current LED  
non-dimmable driver - **supplied****Construction:** Aluminium chassis - white trim finish  
Opal diffuser

Code	Model	Qty
------	-------	-----

LEDPAN3	42W LED panel	1
---------	---------------	---

230V  
50HzIP  
20

**Emergency Option.**  
Convert LEDPAN2 & LEDPAN3 into a 3 hour emergency maintained luminaire by using **EMKIT**

# HF RECESSED MODULAR T5 FLUORESCENT FITTINGS

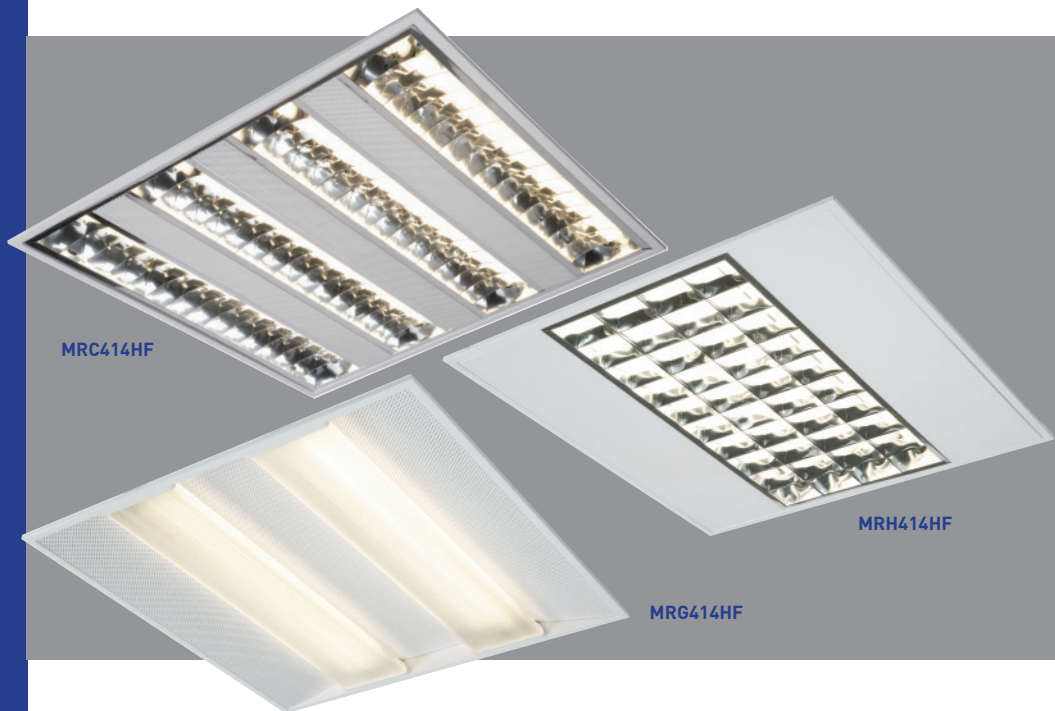

## MRC414HF

**Dimensions:** L: 595mm W: 595mm D: 50mm

**Lamp type:** 4 x 14W T5

**Control gear:** HF soft start

**Construction:** Epoxy coated steel. Double parabolic louvre. Suitable for 600mm x 600mm grid ceilings.

**Emergency option:** Integral 3hr emergency.

Compatible for maintained and non-maintained use.

Code	Model	Qty
MRC414HF	4 x 14W T5 standard	1
MRC414EMHF	4 x 14W T5 emergency	1

## MRG414HF

**Dimensions:** L: 595mm W: 595mm D: 55mm

**Lamp type:** 4 x 14W T5

**Control gear:** HF soft start

**Construction:** Epoxy coated steel. PMMA diffuser with perforated steel side wings

**Emergency option:** Integral 3hr emergency.

Compatible for maintained and non-maintained use.

Code	Model	Qty
MRG414HF	4 x 14W T5 standard	1
MRG414EMHF	4 x 14W T5 emergency	1



## MRH414HF

**Dimensions:** L: 595mm W: 595mm D: 55mm

**Lamp type:** 4 x 14W T5

**Control gear:** HF soft start

**Construction:** Epoxy coated steel. Double parabolic aluminium louvre

**Emergency option:** Integral 3hr emergency.

Compatible for maintained and non-maintained use.

Code	Model	Qty
MRH414HF	4 x 14W T5 standard	1
MRH414EMHF	4 x 14W T5 emergency	1

230V  
50Hz

IP  
20



Lamps not included unless otherwise stated



# HF RECESSED MODULAR T8 FLUORESCENT FITTINGS

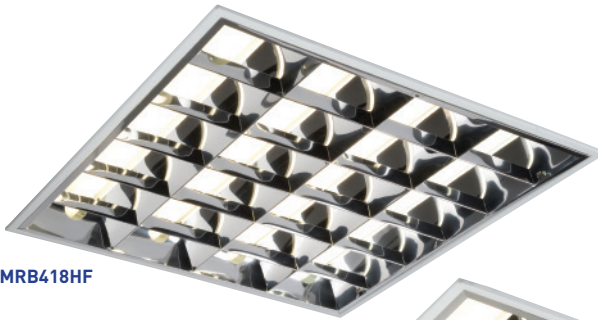

MRB418HF



FR600



MRA436HF



FR1200

## MRB418HF

**Dimensions:** L: 595mm W: 595mm D: 86mm

**Lamp type:** 4 x 18W T8

**Control gear:** HF soft start

**Construction:** Epoxy coated steel. Double parabolic louvre. Suitable for 600mm x 600mm grid ceilings.

**Emergency option:** Integral 3 hour emergency.

Compatible for maintained and non-maintained use.

Code	Model	Qty
MRB418HF	4 x 18W T8 standard	1
MRB418EMHF	4 x 18W T8 emergency	1

## FIRE HOOD

**Dimensions:** W: 600mm L: 600mm

Code	Model	Qty
FR600	Firehood	1

## MRA436HF

**Dimensions:** L: 1195mm W: 595mm D: 86mm

**Lamp type:** 4 x 36W T8

**Control gear:** HF soft start

**Construction:** Epoxy coated steel. Double parabolic louvre. Suitable for 600mm x 1200mm grid ceilings.

**Emergency option:** Integral 3 hour emergency.

Compatible for maintained and non-maintained use.

Code	Model	Qty
MRA436HF	4 x 36W T8 standard	1
MRA436EMHF	4 x 36W T8 emergency	1

## FIRE HOOD

**Dimensions:** W: 600mm L: 1200mm

Code	Model	Qty
FR1200	Firehood	1



Lamps not included unless otherwise stated

# HF RECESSED MODULAR PL FLUORESCENT FITTINGS



MRF255PLHF



MRD255PLHF

MRE255PLHF



## MRF255PLHF

**Dimensions:** L: 595mm W: 595mm D: 100mm

**Lamp type:** 2 x 55W PL 4P

**Control gear:** HF soft start

**Construction:** Epoxy coated steel. Perforated steel lamp cover on sides.

**Emergency option:** Integral 3hr emergency. Compatible for maintained and non-maintained use.

Code	Model	Qty
MRF255PLHF	2 x 55W PL standard	1
MRF255PLEMHF	2 x 55W PL emergency	1

## MRD255PLHF

**Dimensions:** L: 595mm W: 595mm D: 120mm

**Lamp type:** 2 x 55W PL 4P

**Control gear:** HF soft start

**Construction:** Epoxy coated steel. Perforated front panel, ideal for indirect lighting. Suitable for 600mm x 600mm grid ceilings.

**Emergency option:** Integral 3hr emergency. Compatible for maintained and non-maintained use.

Code	Model	Qty
MRD255PLHF	2 x 55W PL standard	1
MRD255PLEMHF	2 x 55W PL emergency	1

## MRE255PLHF

**Dimensions:** L: 595mm W: 595mm D: 120mm

**Lamp type:** 2 x 55W PL 4P

**Control gear:** HF soft start

**Construction:** Epoxy coated steel. Perforated front panel. Suitable for direct and indirect lighting. Double parabolic louvre. Suitable for 600mm x 600mm grid ceilings.

**Emergency option:** Integral 3hr emergency. Compatible for maintained and non-maintained use.

Code	Model	Qty
MRE255PLHF	2 x 55W PL standard	1
MRE255PLEMHF	2 x 55W PL emergency	1



Suitable for 600mm x 600mm grid ceilings

# HF SURFACE MODULAR FLUORESCENT FITTINGS



**SURF436HF**

## **SURF436HF**

**Dimensions:** L: 1220mm W: 600mm D: 80mm

**Lamp type:** 4 x 36W T8

**Control gear:** HF soft start

**Construction:** Surface mounted epoxy coated steel luminaire. Double parabolic louvre

**Emergency option:** Integral 3hr emergency.

Compatible for maintained and non-maintained use.

Code	Model	Qty
<b>SURF436HF</b>	4 x 36W standard	1
<b>SURF436EMHF</b>	4 x 36W emergency	1



**SURF418HF**

## **SURF418HF**

**Dimensions:** L: 600mm W: 600mm D: 75mm

**Lamp type:** 4 x 18W T8

**Control gear:** HF soft start

**Construction:** Surface mounted epoxy coated steel luminaire. Double parabolic louvre

**Emergency option:** Integral 3hr emergency.

Compatible for maintained and non-maintained use.

Code	Model	Qty
<b>SURF418HF</b>	4 x 18W T8 standard	1
<b>SURF418EMHF</b>	4 x 18W T8 emergency	1



**SURF414HF**

## **SURF414HF**

**Dimensions:** L: 595mm W: 595mm D: 75mm

**Lamp type:** 4 x 14W T5

**Control gear:** HF soft start

**Construction:** Surface mounted epoxy coated steel luminaire. Double parabolic louvre

**Emergency option:** Integral 3hr emergency.

Compatible for maintained and non-maintained use.

Code	Model	Qty
<b>SURF414HF</b>	4 x 14W T5 standard	1
<b>SURF414EMHF</b>	4 x 14W T5 emergency	1

230V  
50Hz

IP  
20



Lamps not included unless otherwise stated

# HF SURFACE/SUSPENDED FLUORESCENT FITTINGS

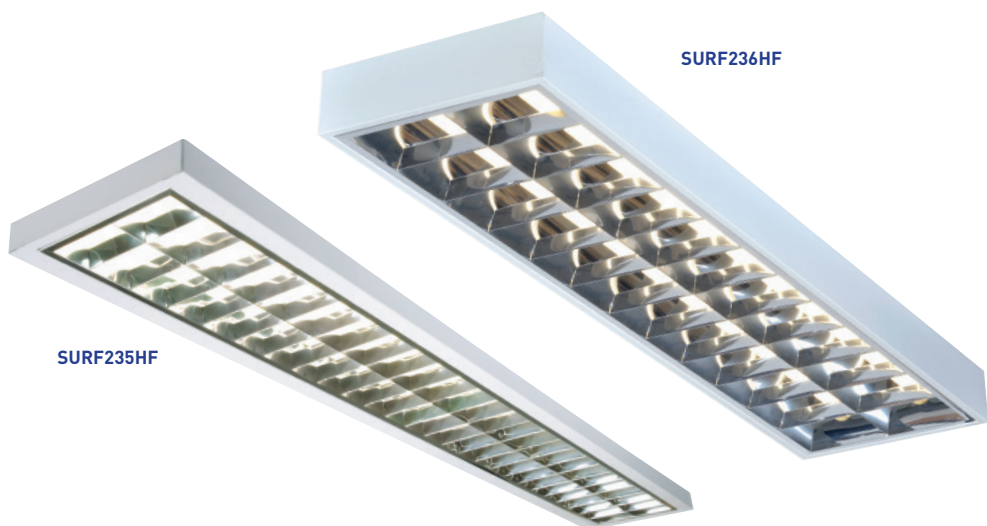

## T8 SURFACE MOUNTED LUMINAIRE

**Dimensions:** D: 80mm L x W (see below)

**Lamp type:** 2 x T8 wattage (see below)

**Control gear:** HF soft start

**Construction:** Surface / suspended epoxy coated steel luminaire. Double parabolic louvre

**Emergency option:** Integral 3hr emergency. Compatible for maintained and non-maintained use.

Code	Model	Length	Width	Qty
<b>SURF236HF</b>	2 x 36W T8 standard	1220mm	305mm	1
<b>SURF236EMHF</b>	2 x 36W T8 emergency	1220mm	305mm	1
<b>SURF258HF</b>	2 x 58W T8 standard	1520mm	305mm	1
<b>SURF258EMHF</b>	2 x 58W T8 emergency	1520mm	305mm	1
<b>SURF270HF</b>	2 x 70W T8 standard	1820mm	300mm	1
<b>SURF270EMHF</b>	2 x 70W T8 emergency	1820mm	300mm	1

## T5 SURFACE MOUNTED LUMINAIRE

**Dimensions:** L: 1485 W: 225mm D: 55mm

**Lamp type:** 2 x 35W T5

**Control gear:** HF soft start

**Construction:** Surface / suspended epoxy coated steel luminaire. Double parabolic louvre

**Emergency option:** Integral 3hr emergency. Compatible for maintained and non-maintained use.

Code	Model	Qty
<b>SURF235HF</b>	2 x 35W T5 standard	1
<b>SURF235EMHF</b>	2 x 35W T5 emergency	1



## SUSPENSION KIT

For all of the above models

Code	Model	Qty
<b>5FTT5KIT</b>	Suspension kit	1



Lamps not included unless otherwise stated

# HF SURFACE/SUSPENDED FLUORESCENT FITTINGS

5FTFLG

5FTFLW

5FTT5WHF

PRS235HF

## 5FTFL

**Dimensions:** L: 1610mm W: 180mm D: 60mm

**Lamp type:** 2 x 58W T8

**Control gear:** HF soft start

**Construction:** Powder coated steel. Standard louvre. Can be surface mounted or suspended by chain.

Code	Model	Qty
5FTFLW	2 x 58W T8 white	1
5FTFLG	2 x 58W T8 grey	1

## 5FTT5WHF

**Dimensions:** L: 1515mm W: 295mm D: 85mm

**Lamp type:** 2 x 35W T5

**Control gear:** HF soft start

**Construction:** Powder coated steel. Surface mounted or suspended, with removable plate to allow for indirect lighting in suspended state

**Emergency option:** Integral 3 hour emergency.

Compatible for maintained and non-maintained use.

Code	Model	Qty
5FTT5WHF	2 x 35W T5 standard	1
5FTT5WEMHF	2 x 35W T5 emergency	1

## PRS235HF

**Dimensions:** L: 1505mm W: 200mm D: 70mm

**Lamp type:** 2 x 35W T5

**Control gear:** HF soft start

**Construction:** Powder coated steel. Prismatic diffuser with polycarbonate end caps

**Emergency option:** Integral 3 hour emergency.

Compatible for maintained and non-maintained use.

Code	Model	Qty
PRS235HF	2 x 35W T5 standard	1
PRS235EMHF	2 x 35W T5 emergency	1

## SUSPENSION KIT

Code	Model	Qty
5FTT5KIT	Suspension kit	1



Lamps not included unless otherwise stated

# LED LINEAR BATTENS AND ACCESSORIES



**LIN**

**LED**

**Dimensions:** W: 75mm D: 32mm  
**Lamp type:** LED (included) 4000K Cool White  
**Construction:** Aluminium / Polycarbonate

Code	Model	Length	Qty
LIN1	230V 10W Batten	280mm	1
LIN2	230V 18W Batten	580mm	1
LIN3	230V 35W Batten	1180mm	1
LIN4	230V 55W Batten	1480mm	1

This range of LED battens boast an ultra-low profile and high lumen output. Manufactured with an impact resistant aluminium body and polycarbonate diffuser, it creates a versatile lightweight and robust light fixture. It is suitable for all commercial, retail and domestic areas. They are cost effective, energy efficient, low maintenance, long life alternative to fluorescent battens. Features include dual input power source and easy to install clip on brackets. Supplied 4000K Cool White as standard. Includes one power feed (500mm) one link cable (200mm) and one link feed. Accessories available include suspension kit, extension connectors and link connectors. 3 year warranty.



**Includes Accessories**



## ADDITIONAL ACCESSORIES FOR LED LINEAR BATTENS



Code	Model	Qty
LINCUP	Seamless Coupler	5
LIN200	Link Power Cord 200mm	1
LIN300	Link Power Cord 300mm	1
LIN450	Link Power Cord 450mm	1
LINP	Power Cable 500mm	1
LINS	Ceiling Suspension Kit	1

## SUSPENDED LUMINAIRES

High specification, build and finish. All luminaires supplied with 1500mm stainless steel adjustable suspension kit and pre-wired power feed. 4000K. Non-dimmable.

### SPT51

**Dimensions:** L: 1490mm W: 95mm D:95mm

**Lamp type:** 1 x 35W T5- **supplied**

**Control gear:** HF soft start

**Construction:** Aluminium body PMMA diffuser.

Direct/indirect light source.

Code	Model	Qty
SPT51	1 x 35W T5 suspended luminaire	1

### SPT52

**Dimensions:** L: 1490mm W: 150mm H:65mm

**Lamp type:** 2 x 35W T5- **supplied**

**Control gear:** HF soft start

**Construction:** Aluminium body PMMA diffuser.

Direct/indirect light source.

Code	Model	Qty
SPT52	2 x 35W T5 suspended luminaire	1



### SPLED2

**Dimensions:** L: 1530mm W: 105mm H:25mm

**Lamp type:** 36W LED 3200lm - **supplied**

**Control gear:** LED Driver

**Construction:** Aluminium body PMMA diffuser.

Direct/indirect light source.

Code	Model	Qty
SPLED2	36W LED suspended luminaire	1

LED



### LEDBAT

**Dimensions:** W: 30mm D: 45mm

**Lamp type:** LED 4000K - **supplied**,

**Construction:** Aluminium / Polycarbonate

Code	Model	Length	Qty
LEDBAT10	230V 10W 605mm	605mm (2ft)	1
LEDBAT20	230V 20W 1220mm	1220mm (4ft)	1
LEDBAT25	230V 25W 1520mm	1520mm (5ft)	1



Manufactured from aluminium with polycarbonate diffuser. Double insulated, lightweight, versatile and slimline. Simple to install via an easy wire terminal box on the rear. Alternative to T5/T8 batten. Ideal for commercial, retail and domestic use under cabinets, hallways and kitchens. Supplied with integral driver, non-dimmable.

230V  
50Hz

IP  
20



# T8 HF FLUORESCENT BATTENS

## T8 HF SINGLE BATTENS

**Dimensions:** W: 61mm D: 82mm L: see below

**Lamp type:** 1 x T8 **Control gear:** HF soft start

**Construction:** Powder coated mild steel.

Code	Model	Length	Qty
T8118HF	1 x 18W	(2ft) 617mm	1
T8136HF	1 x 36W	(4ft) 1227mm	4
T8158HF	1 x 58W	(5ft) 1527mm	4
T8170HF	1 x 70W	(6ft) 1791mm	4

## T8 HF SINGLE BATTENS - EMERGENCY

**Dimensions:** W: 61mm D: 82mm L: see below

**Lamp type:** 1 x T8 **Control gear:** Integral HF soft start  
3hour emergency. Compatible for maintained and non-maintained use

Code	Model	Length	Qty
T8136EMHF	1 x 36W emergency	(4ft) 1227mm	1
T8158EMHF	1 x 58W emergency	(5ft) 1527mm	1
T8170EMHF	1 x 70W emergency	(6ft) 1791mm	1

## T8 HF TWIN BATTENS

**Dimensions:** W: 101mm D: 86mm L: see below

**Lamp type:** 2 x T8 **Control gear:** HF soft start

**Construction:** Powder coated mild steel.

Code	Model	Length	Qty
T8218HF	2 x 18W	(2ft) 617mm	4
T8236HF	2 x 36W	(4ft) 1227mm	4
T8258HF	2 x 58W	(5ft) 1527mm	4
T8270HF	2 x 70W	(6ft) 1791mm	4

## T8 HF TWIN BATTENS - EMERGENCY

**Dimensions:** W: 101mm D: 86mm L: see below

**Lamp type:** 2 x T8 **Control gear:** Integral HF soft start  
3hour emergency. Compatible for maintained and non-maintained use

Code	Model	Length	Qty
T8236EMHF	2 x 36W emergency	(4ft) 1227mm	1
T8258EMHF	2 x 58W emergency	(5ft) 1527mm	1
T8270EMHF	2 x 70W emergency	(6ft) 1791mm	1

## T8 PRISMATIC DIFFUSERS

Code	Model	Length	Qty
T8DIFF136	Diffuser for 1 x 36W	(4ft)	2
T8DIFF158	Diffuser for 1 x 58W	(5ft)	2
T8DIFF170	Diffuser for 1 x 70W	(6ft)	2
T8DIFF236	Diffuser for 2 x 36W	(4ft)	2
T8DIFF258	Diffuser for 2 x 58W	(5ft)	2
T8DIFF270	Diffuser for 2 x 70W	(6ft)	2



T8118HF

T8236HF

T8DIFF136

T8DIFF236

T8REF36

## T8 REFLECTORS

Code	Model	Length	Qty
T8REF36	Reflector for 36W	(4ft)	4
T8REF58	Reflector for 58W	(5ft)	4
T8REF70	Reflector for 70W	(6ft)	4





## T8 LED READY BATTENS AND T8 LED TUBES

Energy-efficient, long life, cost effective alternative to classic T8 fluorescent lamps. Manufactured from shatterproof, robust polycarbonate. Instant ignition provides uniform illumination. Integral driver and mercury free components ensure safe environment. Non-dimmable. Ideally for use with Knightsbridge dedicated LED battens however can be used with most prewired dedicated LED battens. Not for use with external electronic or magnetic ballasts.

T8LB14/T8LB15/T8LB16

SHOWN WITH LAMP  
(NOT INCLUDED)

### T8 LED BATTENS

LED

Dimensions: H: 80 x W: 63 mm

Code	Description	Length	Qty
T8LB14	Single T8 LED Batten	(4ft) 1225mm	4
T8LB15	Single T8 LED Batten	(5ft) 1525mm	4
T8LB16	Single T8 LED Batten	(6ft) 1778mm	4
T8LB24	Twin T8 LED Batten	(4ft) 1225mm	4
T8LB25	Twin T8 LED Batten	(5ft) 1525mm	4
T8LB26	Twin T8 LED Batten	(6ft) 1778mm	4

All require T8 LED Tubes. Please see below.

T8LB24/T8LB25/T8LB26

### T8 LED TUBES

Code	Description	Length	Lumens	Qty
T8LED4	230V T8 20W LED Tube	(4ft) 1214mm	4000K	1
T8LED4D	230V T8 20W LED Tube	(4ft) 1214mm	6000K	1
T8LED5	230V T8 24W LED Tube	(5ft) 1514mm	4000K	1
T8LED5D	230V T8 24W LED Tube	(5ft) 1514mm	6000K	1
T8LED6	230V T8 30W LED Tube	(6ft) 1767mm	4000K	1
T8LED6D	230V T8 30W LED Tube	(6ft) 1767mm	6000K	1

SHOWN WITH LAMP  
(NOT INCLUDED)

230V  
50Hz

IP  
20



## T5 HF FLUORESCENT BATTENS

Knightsbridge® T5 fluorescent battens are HF soft start ballast as standard. Mild steel body. White finish with polycarbonate lamp holder and end caps. Suits most industrial, retail, commercial office and education applications. Ceiling or wall mounted. Polycarbonate Diffuser/Controller available to improve performance and aesthetics. Lamp(s) not included.

**T5114** shown with optional polycarbonate diffuser **T5DIF2**

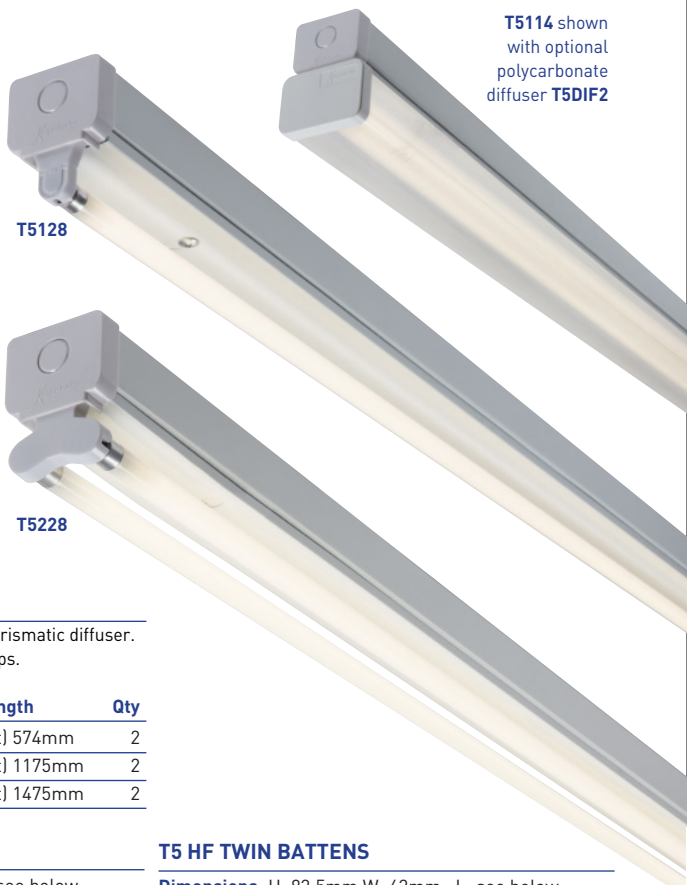

### T5 PRISMATIC DIFFUSER PACK

Streamlined, anti-glare, polycarbonate prismatic diffuser. Sold in packs of 2. Complete with end caps. Diffuser fits single and twin fittings.

Code	Model	Length	Qty
<b>T5DIF2</b>	T5 prismatic diffuser	(2ft) 574mm	2
<b>T5DIF4</b>	T5 prismatic diffuser	(4ft) 1175mm	2
<b>T5DIF5</b>	T5 prismatic diffuser	(5ft) 1475mm	2

### T5 HF SINGLE BATTENS

**Dimensions:** H:82.5mm W: 63mm L: see below  
**Lamp type:** 1 x T5 **Control gear:** HF soft start

Code	Model	Length	Qty
<b>T5114</b>	1 x 14W batten	(2ft) 574mm	4
<b>T5128</b>	1 x 28W batten	(4ft) 1175mm	4
<b>T5135</b>	1 x 35W batten	(5ft) 1475mm	4
<b>T5149</b>	1 x 49W batten	(5ft) 1475mm	4

### T5 HF TWIN BATTENS

**Dimensions:** H: 83.5mm W: 63mm L: see below  
**Lamp type:** 2 x T5 **Control gear:** HF soft start

Code	Model	Length	Qty
<b>T5214</b>	2 x 14W batten	(2ft) 574mm	4
<b>T5228</b>	2 x 28W batten	(4ft) 1175mm	4
<b>T5235</b>	2 x 35W batten	(5ft) 1475mm	4
<b>T5249</b>	2 x 49W batten	(5ft) 1475mm	4

### T5 HF SINGLE BATTENS - EMERGENCY

**Dimensions:** H:82.5mm W: 63mm L: see below  
**Lamp type:** 1 x T5 **Control gear:** Integral HF soft start 3 hour emergency. Compatible for maintained use

Code	Model	Length	Qty
<b>T5128EM</b>	1 x 28W batten	(4ft) 1175mm	1
<b>T5135EM</b>	1 x 35W batten	(5ft) 1475mm	1
<b>T5149EM</b>	1 x 49W batten	(5ft) 1475mm	1

### T5 HF TWIN BATTENS - EMERGENCY

**Dimensions:** H: 83.5mm W: 63mm L: see below  
**Lamp type:** 2 x T5 **Control gear:** Integral HF soft start 3 hour emergency. Compatible for maintained use

Code	Model	Length	Qty
<b>T5228EM</b>	2 x 28W batten	(4ft) 1175mm	1
<b>T5235EM</b>	2 x 35W batten	(5ft) 1475mm	1
<b>T5249EM</b>	2 x 49W batten	(5ft) 1475mm	1



Lamps not included unless otherwise stated

Exclusive to Knightsbridge. 230V high output LED range of battens. Dedicated non-replaceable LED light source with polycarbonate diffuser. Traditional T8 powder coated steel body. Purposely designed around the traditional T8 body to suit refurbishment and projects with the appearance of a T8 batten. Polycarbonate diffuser ensures strength and security resulting in minimal damage. Virtually maintenance free. Ideal for replacement or as an alternative for T5/T8. Perfect for indoor use in commercial, retail and domestic environments.

Supplied in Cool White - 4000K. Available in 4 different lengths with emergency options available. IP20, non-dimmable. 5 year limited warranty. Compatible with external microwave and sensor controls.

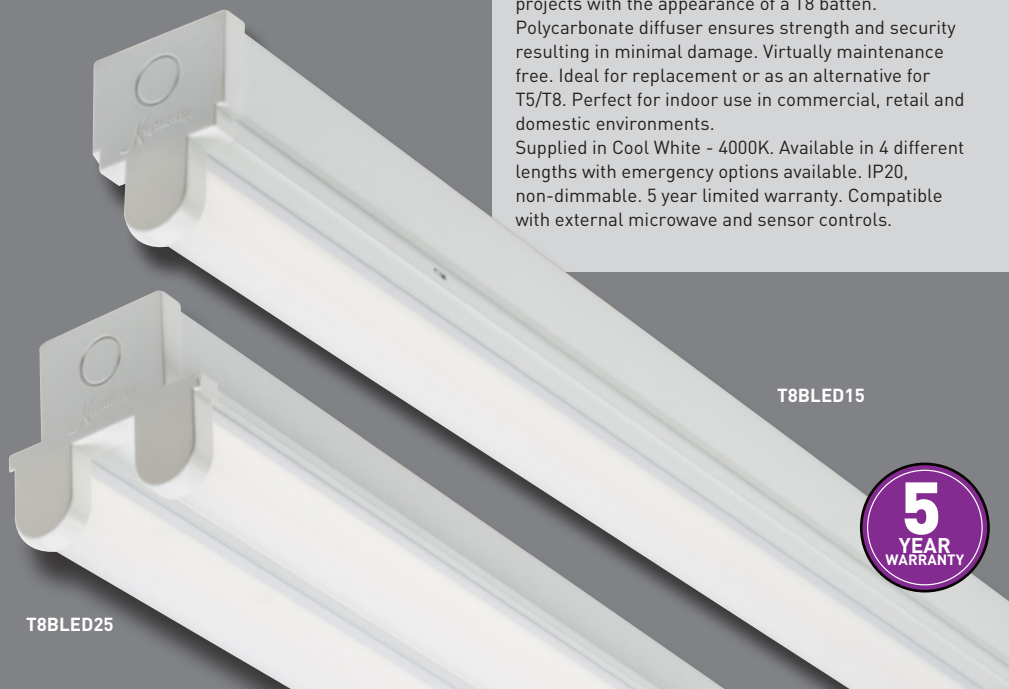

T8BLED15

T8BLED25



### T8BLED Single LED Batten

**Dimensions:** W: 60mm D: 85mm  
**Lamp type:** LED (supplied) 4000K  
**Construction:** Steel & Polycarbonate

Code	Model	Length	Lumens	Qty
T8BLED12	230V 10W (2ft) 615mm	1200	1	
T8BLED14	230V 20W (4ft) 1225mm	2300	1	
T8BLED15	230V 26W (5ft) 1525mm	3000	1	
T8BLED15EM	230V 26W (5ft) 1525mm emergency	3000	1	
T8BLED16	230V 30W (6ft) 1790mm	3450	1	
T8BLED16EM	230V 30W (6ft) 1790mm emergency	3450	1	

### T8BLED Twin LED Batten

**Dimensions:** W: 95mm D: 85mm  
**Lamp type:** LED (supplied) 4000K  
**Construction:** Steel & Polycarbonate

Code	Model	Length	Lumens	Qty
T8BLED22	230V 20W (2ft) 615mm	2200	1	
T8BLED24	230V 40W (4ft) 1225mm	4500	1	
T8BLED25	230V 50W (5ft) 1525mm	5300	1	
T8BLED25EM	230V 50W (5ft) 1525mm emergency	5300	1	
T8BLED26	230V 60W (6ft) 1790mm	6500	1	
T8BLED26EM	230V 60W (6ft) 1790mm emergency	6500	1	

230V  
50HzIP  
20

# LED NON-CORROSIVE FLUORESCENT



NCLED36 / NCLED48



230V, IP65 LED Non-corrosive fitting. Supplied in 4000K cool white, new slimline low profile design. Durable, robust polycarbonate base and diffuser, optimized for LED use. Surface mounted or suspended. Supplied with LED driver and dedicated LED light source with new aluminium heatsink. Innovative wiring system enables the luminaire to be fed from the outside without the need to open the product at all. Supplied complete with terminal blocks for series wiring. Wiring via rear access terminal box. Low energy, long life and maintenance free makes it an ideal alternative to conventional T8/T5.

## NCLED

**Dimensions:** W: 95mm D: 100mm L: see below

**Lamp type:** LED 4000K Supplied

Code	Model	Length	Qty
NCLED36	230V IP65 36W LED Non-Corrosive	1180mm	1
NCLED48	230V IP65 48W LED Non-Corrosive	1480mm	1
NCLED36EM	230V IP65 36W LED Non-Corrosive 3 hour Emergency	1180mm	1
NCLED48EM	230V IP65 48W LED Non-Corrosive 3 hour Emergency	1480mm	1



# T8 HF NON-CORROSIVE FLUORESCENT



TR65136HF

TR65218HF

Manufactured from extremely strong and robust polycarbonate. High output polycarbonate prism lens for optimum light output. Min / max operating temperatures: -15°C / +30°C

- Polycarbonate clips. Fixing brackets and 20mm compression gland included
- Can be surface mounted or suspended - c/w suspension eye

## IP65 T8 HF SINGLE NON-CORROSIVE

**Dimensions:** W: 95mm D: 100mm L: see below

**Lamp type:** 1 x T8 **Control gear:** HF soft start

Code	Model	Length	Qty
TR65118HF	1 x 18W	(2ft) 655mm	1
TR65136HF	1 x 36W	(4ft) 1265mm	1
TR65158HF	1 x 58W	(5ft) 1565mm	1
TR65170HF	1 x 70W	(6ft) 1830mm	1

## IP65 T8 HF SINGLE NON-CORROSIVE - EMERGENCY

**Dimensions:** W: 95mm D: 100mm L: see below

**Lamp type:** 1 x T8 **Control gear:** Integral HF soft start 3 hour emergency. Compatible for maintained and non-maintained use

Code	Model	Length	Qty
TR65136EMHF	1 x 36W	(4ft) 1265mm	1
TR65158EMHF	1 x 58W	(5ft) 1565mm	1
TR65170EMHF	1 x 70W	(6ft) 1830mm	1

## IP65 T8 HF TWIN NON-CORROSIVE

**Dimensions:** W: 145mm D: 110mm L: see below

**Lamp type:** 2 x T8 **Control gear:** HF soft start

Code	Model	Length	Qty
TR65218HF	2 x 18W	(2ft) 655mm	1
TR65236HF	2 x 36W	(4ft) 1265mm	1
TR65258HF	2 x 58W	(5ft) 1565mm	1
TR65270HF	2 x 70W	(6ft) 1830mm	1

## IP65 T8 HF TWIN NON-CORROSIVE - EMERGENCY

**Dimensions:** W: 145mm D: 110mm L: see below

**Lamp type:** 2 x T8 **Control gear:** Integral HF soft start 3 hour emergency. Compatible for maintained and non-maintained use

Code	Model	Length	Qty
TR65218EMHF	2 x 18W	(2ft) 655mm	1
TR65236EMHF	2 x 36W	(4ft) 1265mm	1
TR65258EMHF	2 x 58W	(5ft) 1565mm	1
TR65270EMHF	2 x 70W	(6ft) 1830mm	1



Lamps not included unless otherwise stated

# T5 HF NON-CORROSIVE FLUORESCENT



NC65114HF

NC65228HF

NCT5CLIP

New slimline, lightweight design, manufactured from extremely strong and robust polycarbonate. High output polycarbonate prism lens for optimum light output. Min / max operating temperatures: -15°C / +30°C

- Polycarbonate clips, fixing brackets and 20mm compression gland included.
- Can be surface mounted or suspended - c/w suspension eye
- Stainless steel clips available (**NCT5CLIP**)

## IP65 T5 HF SINGLE NON-CORROSIVE

**Dimensions:** W: 65mm D: 75mm

**Lamp type:** 1 x T5

**Control gear:** HF soft start

Code	Model	Length	Qty
NC65114HF	14W	(2ft) 610mm	1
NC65128HF	28W	(4ft) 1210mm	1
NC65135HF	35W	(5ft) 1510mm	1

## IP65 T5 HF TWIN NON-CORROSIVE

**Dimensions:** W: 104mm D: 75mm

**Lamp type:** 2 x T5

**Control gear:** HF soft start

Code	Model	Length	Qty
NC65214HF	2 x 14W	(2ft) 610mm	1
NC65228HF	2 x 28W	(4ft) 1210mm	1
NC65235HF	2 x 35W	(5ft) 1510mm	1

## IP65 T5 HF SINGLE NON-CORROSIVE - EMERGENCY

**Dimensions:** W: 65mm D: 75mm

**Lamp type:** 1 x 35W 5ft T5 **Control gear:** Integral HF soft start 3 hour emergency. Compatible for maintained and non-maintained use

Code	Model	Length	Qty
NC65135EMHF	35W	5ft 1510mm	1

## IP65 T5 HF TWIN NON-CORROSIVE - EMERGENCY

**Dimensions:** W: 104mm D: 75mm

**Lamp type:** 2 x 35W 5ft T5 **Control gear:** Integral HF soft start 3 hour emergency. Compatible for maintained and non-maintained use

Code	Model	Length	Qty
NC65235EMHF	2 x 35W	(5ft) 1510mm	1

## NCT5CLIP STAINLESS STEEL CLIPS

Optional stainless steel clips for T5 non-corrosive fittings.

Code	Model	Qty
NCT5CLIP	Stainless steel clip	20

230V  
50Hz

IP  
65



Lamps not included unless otherwise stated

# 110V T8 NON-CORROSIVE FLUORESCENT



TR651581HF

TR652181HF



CLIP1

Manufactured from extremely strong and robust yellow polycarbonate. High output polycarbonate prism lens for optimum light output. Min / max operating temperatures:  $-15^{\circ}\text{C}$  /  $+30^{\circ}\text{C}$

- Polycarbonate clips. Fixing brackets and 20mm compression gland included
- Can be surface mounted or suspended - c/w suspension eye

## 110V IP65 T8 SINGLE LAMP HF

**Dimensions:** W: 95mm D: 100mm L: (see below)

**Lamp type:** 1 x T8 **Control gear:** HF soft start

Code	Model	Length	Qty
TR651181HF	1 x 18W	(2ft) 655mm	1
TR651581HF	1 x 58W	(5ft) 1565mm	1

## 110V IP65 T8 SINGLE LAMP HF EMERGENCY

**Dimensions:** W: 95mm D: 100mm L: (see below)

**Lamp type:** 1 x T8 **Control gear:** Integral HF soft start  
3 hour emergency. Compatible for maintained and non-maintained use

Code	Model	Length	Qty
TR651581EMHF	1 x 58W	(5ft) 1565mm	1

## 110V IP65 T8 TWIN LAMP HF

**Dimensions:** W: 145mm D: 110mm L: (see below)

**Lamp type:** 2 x T8 **Control gear:** HF soft start

Code	Model	Length	Qty
TR652181HF	2 x 18W	(2ft) 655mm	1
TR652581HF	2 x 58W	(5ft) 1565mm	1

## 110V IP65 T8 TWIN LAMP HF EMERGENCY

**Dimensions:** W: 145mm D: 110mm L: (see below)

**Lamp type:** 2 x T8 **Control gear:** Integral HF soft start  
3 hour emergency. Compatible for maintained and non-maintained use

Code	Model	Length	Qty
TR652181EMHF	2 x 18W	(2ft) 655mm	1
TR652581EMHF	2 x 58W	(5ft) 1565mm	1

## STAINLESS STEEL CLIPS

Stainless steel diffuser clips for non-corrosive fittings.

Code	Model	Qty
CLIP1	Stainless steel clip	20

110V

IP  
65



Lamps not included unless otherwise stated



# We're only a click away.

K-Direct is a quick and reliable home delivery service that provides next day delivery (across mainland UK) with a no minimum order value or quantity. Simply place your customer's order online and have it delivered direct on your behalf. Cut out the time spent double handling and order exactly what you want without having to order minimum product quantities. Don't let logistics stand in the way of you and our fantastic products - order with K-Direct and ensure a professional, fast and efficient delivery service.

- **No minimum order value**
- **No minimum box quantity**
- **Fast, efficient and professional**
- **Next day delivery (across mainland UK)**
- **Created for our wholesalers to satisfy their customers.**

Our newly redesigned responsive website ensures, however you access our products, your experience is quick and hassle free.



## Quality products, first class delivery





## Section Index

IP44 Flush Trade LED Bulkheads	192
IP54 12W/20W LED Bulkheads	193
IP44 LED Bulkheads	194
IP44 Polo LED Bulkheads and Accessories	195-197
IP20/IP65 Round Luminaires	198
IP65 Luminaires	199
Amenity Bulkheads	200



P192

# IP44 FLUSH TRADE LED BULKHEADS



BT14

BT14/20 surface mounted IP44 dedicated low profile LED bulkheads are suitable for both domestic and commercial applications, for walls and ceilings. Lightweight and energy efficient, manufactured from robust polycarbonate with integral dedicated LED, its specially designed anti-glare diffuser emits high level lumens. The 3 year warranty makes this affordable luminaire a real alternative to fluorescent with all the features and benefits of LED. Also available in microwave sensor and emergency options. Optional chrome trims available **BT14CHR** and **BT20CHR**.



## 14W IP44 FLUSH TRADE LED

**Dimensions:** Ø: 315mm D: 74mm  
**Lamp type:** SMD LED - **supplied**  
**Control gear:** LED driver

LED

Code	Model	Colour	lm	Qty
<b>BT14</b>	14W LED Bulkhead	4000K	900	1
<b>BT14S</b>	14W LED c/w sensor	4000K	900	1
<b>BT14EM</b>	14W LED Emergency	4000K	900	1
<b>BT14EMS</b>	14W LED Emergency c/w sensor	4000K	900	1
<b>BT14D</b>	14W LED Bulkhead	6000K	1000	1
<b>BT14DS</b>	14W LED c/w sensor	6000K	1000	1
<b>BT14DEM</b>	14W LED emergency	6000K	1000	1
<b>BT14DEMS</b>	14W LED Emergency c/w sensor	6000K	1000	1
<b>BT14CHR</b>	Chrome bezel accessory for BT14 Range 315mm bulkhead			1

## 20W IP44 FLUSH TRADE LED

**Dimensions:** Ø: 380mm D: 81mm  
**Lamp type:** SMD LED - **supplied**  
**Control gear:** LED driver

LED

Code	Model	Colour	lm	Qty
<b>BT20</b>	20W LED Bulkhead	4000K	1400	1
<b>BT20S</b>	20W LED c/w sensor	4000K	1400	1
<b>BT20EM</b>	20W LED	4000K	1400	1
<b>BT20EMS</b>	20W LED Emergency c/w sensor	4000K	1400	1
<b>BT20D</b>	20W LED Bulkhead	6000K	1500	1
<b>BT20DS</b>	20W LED c/w sensor	6000K	1500	1
<b>BT20DEM</b>	20W LED emergency	6000K	1500	1
<b>BT20DEMS</b>	20W LED emergency c/w sensor	6000K	1500	1
<b>BT20CHR</b>	Chrome bezel accessory BT20 Range 380mm bulkhead			1





**20W**  
DIAMETER 400mm



**12W**  
DIAMETER 305mm



- Complete with hinged gear tray for easy installation
- Available in 2 sizes
- Light source included
- Ideal for commercial and domestic use
- Available in standard, microwave sensor and emergency
- Designed exclusively for Knightsbridge®

**12W IP54 LED BULKHEAD**

**LED**

**Dimensions:** Ø: 305mm D: 84mm  
**Lamp type:** SMD LED - **supplied**  
**Lamp data:** 4000K 1000lm  
**Control gear:** LED driver

**20W IP54 LED BULKHEAD**

**LED**

**Dimensions:** Ø: 400mm D: 96mm  
**Lamp type:** SMD LED - **supplied**  
**Lamp data:** 4000K 1600lm  
**Control gear:** LED driver

Code	Model	Qty
<b>BL12LED</b>	12W LED Bulkhead 4000K Standard	1
<b>BL12LEDE</b>	12W LED Bulkhead 4000K Emergency	1
<b>BL12LEDS</b>	12W LED Bulkhead 4000K c/w sensor	1
<b>BL20LED</b>	20W LED Bulkhead 4000K Standard	1
<b>BL20LEDE</b>	20W LED Bulkhead 4000K Emergency	1
<b>BL20LEDS</b>	20W LED Bulkhead 4000K c/w sensor	1



## IP44 LED BULKHEADS



### BF1430 - 14W LED BULKHEAD

LED

Dimensions: Ø: 300mm D: 97mm

Lamp type: 14W LED - **BF14L6K** supplied

Lamp data: 6000K 1020lm

Control gear: LED Driver

Control gear: Emergency 3hr maintained

Code	Model	Qty
<b>BF1430</b>	14W LED Bulkhead	1
<b>BF1430S</b>	14W LED Bulkhead with sensor	1
<b>BF1430EM</b>	14W LED Bulkhead - 3hr emergency	1
<b>BF1430EMS</b>	14W LED Bulkhead - 3hr emergency c/w sensor	1
<b>BF14L4K</b>	Replacement LED tray 14W 4000K	1
<b>BF14L6K</b>	Replacement LED tray 14W 6000K	1

### BF2440 - 24W LED BULKHEAD

LED

Dimensions: Ø: 400mm D: 117mm

Lamp type: 24W LED - **BF24L6K** supplied

Lamp data: 6000K 1800lm

Control gear: LED Driver

Control gear: Emergency 3hr maintained

Code	Model	Qty
<b>BF2440</b>	24W LED Bulkhead	1
<b>BF2440S</b>	24W LED Bulkhead with sensor	1
<b>BF2440EM</b>	24W LED Bulkhead - 3hr emergency	1
<b>BF2440EMS</b>	24W LED Bulkhead - 3hr emergency c/w sensor	1
<b>BF24L4K</b>	Replacement LED tray 24W 4000K	1
<b>BF24L6K</b>	Replacement LED tray 24W 6000K	1

BRASS  
BEZEL

CHROME  
BEZEL

MATT SILVER  
BEZEL

WHITE  
BEZEL



#### 300mm COLOURED TRIMS

Code	Model	Qty
<b>BF14BBR</b>	300mm matt brass bezel	1
<b>BF14BCHR</b>	300mm chrome bezel	1
<b>BF14BMS</b>	300mm matt silver bezel	1
<b>BF14BWHT</b>	300mm white bezel	1

#### 400mm COLOURED TRIMS

Code	Model	Qty
<b>BF24BBR</b>	400mm matt brass bezel	1
<b>BF24BCHR</b>	400mm chrome bezel	1
<b>BF24BMS</b>	400mm matt silver bezel	1
<b>BF24BWHT</b>	400mm white bezel	1

230V  
50Hz

IP  
44



## IP44 POLO LED BULKHEADS

### 14W POLO LED IP44

LED

**Dimensions:** Ø: 330mm D: 110mm

**Lamp type:** 14W LED - **supplied**

**Lamp data:** 6000K, 1200lm

**Construction:** Polycarbonate body with a new specially designed diffuser ensures optimum lumens are reached. Energy efficient. Cool running. Ideal for interior or exterior use. Suitable for commercial and domestic use. Available with sensor and emergency/sensor. Range of coloured trims available (supplied with white as standard).

Code	Model	Qty
TPB14LED	14W LED Bulkhead standard	1
TPB14EMLED	14W LED Bulkhead emergency	1
TPB14SLED	14W LED Bulkhead c/w sensor	1
TPB14EMSLED	14W LED Bulkhead emergency c/w sensor	1

230V  
50Hz

IP  
44



TPB14LED

## POLO BULKHEAD TRIMS



TPB33BRRG



TPB33CHRG



TPB33MSRG

### POLO TRIMS FOR TPB14LED

Code	Model	Qty
TPB33BRRG	Brass trim accessory	1
TPB33CHRG	Chrome trim accessory	1
TPB33MSRG	Matt silver trim accessory	1

## IP44 POLO BULKHEADS



TPB28WOHF



TPB28WPHF

The Polo is a decorative IP44 rated low profile luminaire for internal or external use that can be wall or ceiling mounted. Manufactured from tough polycarbonate with HF soft start electronic control gear in all models. Supplied as standard in white. Three further optional colour trims are available; brass, chrome or matt silver. Choose from opal or prismatic diffusers.

Twist and lock mechanism allows for easy lamp change and maintenance. Offered in two sizes 16W Ø270mm and 28/38W Ø330mm with optional emergency version in 28W.

**All Polo bulkheads are supplied complete with 2D 3500K lamp**

### 28W POLO

**Dimensions:** Ø: 330mm D: 110mm

**Lamp type:** 2D 28W4P - **supplied**

**Control gear:** HF soft start

Code	Model	Qty
TPB28WPHF	28W c/w Prismatic diffuser	1
TPB28WOHF	28W c/w Opal diffuser	1
TPB28MSHF	28W c/w Opal diffuser c/w sensor 1	1

### 28W POLO - EMERGENCY

**Dimensions:** Ø: 330mm D: 110mm

**Lamp type:** 2D 38W4P - **supplied**

**Control gear:** HF combined 3hr maintained emergency

Code	Model	Qty
TPB28WPEMHF	28W c/w Prismatic diffuser	1
TPB28WOEMHF	28W c/w Opal diffuser	1
TPB28MSEMHF	28W c/w Opal diffuser c/w sensor 1	1

230V  
50Hz

IP  
44



## POLO ACCESSORIES

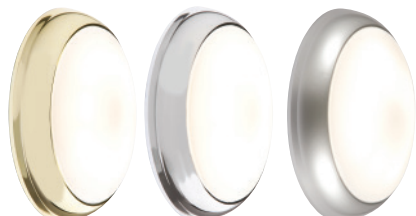

TPB33BRRG

TPB33CHR

TPB33MSRG



TPB28EMPL



MSENSOR

## POLO TRIMS FOR 28W AND 38W MODELS

Code	Model	Qty
TPB33BRRG	Brass trim accessory	1
TPB33CHR	Chrome trim accessory	1
TPB33MSRG	Matt silver trim accessory	1
TPB33WHRG	White trim accessory	1

## POLO EMERGENCY GEAR TRAY

Code	Model	Qty
TPB28EMPL	Polo 2D 28W EM3 plate. Converts 28W TPB bulkheads into emergency versions	1
MSENSOR	Microwave sensor only. Max 1000W	1



**TPB16WOHF**  
shown with **TPB16CHRG**



**TPB16WPHF**



**TPB38WOHF**  
shown with **TPB33BRRG**



**TPB16CHRG**

**TPB16BRRG**

**TPB16WHRG**

## 16W POLO

**Dimensions:** Ø: 270mm D: 95mm

**Lamp type:** 2D 16W4P - **supplied**

**Control gear:** HF soft start

Code	Model	Qty
<b>TPB16WPHF</b>	16W c/w Prismatic diffuser	1
<b>TPB16WOHF</b>	16W c/w Opal diffuser	1

## 16W POLO TRIMS

Code	Model	Qty
<b>TPB16BRRG</b>	Brass trim accessory	1
<b>TPB16CHRG</b>	Chrome trim accessory	1
<b>TPB16WHRG</b>	White trim accessory	1

## 38W POLO

**Dimensions:** Ø: 330mm D: 110mm

**Lamp type:** 2D 38W4P - **supplied**

**Control gear:** HF soft start

Code	Model	Qty
<b>TPB38WPHF</b>	38W c/w Prismatic diffuser	1
<b>TPB38WOHF</b>	38W c/w Opal diffuser	1



## ROUND LUMINAIRES

### TP28W2DHF



### TP28W2DEMCHF



### TP28W2D

**Dimensions:** Ø: 410mm D: 110mm  
**Lamp type:** 2D 28W4P 3500K - supplied  
**Control gear:** HF soft start  
**Construction:** Polycarbonate.

Code	Model	Qty
TP28W2DHF	28W c/w Opal diffuser - white trim	1
TP28W2DCHF	28W c/w Opal diffuser - chrome trim	1
TP28W2DEMHF	28W c/w Opal diffuser - white trim	1
TP28W2DCEMHF	28W c/w Opal diffuser - chrome trim	1

### TP38W2D

**Dimensions:** Ø: 410mm D: 110mm  
**Lamp type:** 2D 38W4P 3500K - supplied  
**Control gear:** HF soft start  
**Construction:** Polycarbonate.

Code	Model	Qty
TP38W2DHF	38W c/w Opal diffuser - white trim	1
TP38W2DCHF	38W c/w Opal diffuser - chrome trim	1



### TPR14 LED BULKHEAD

**Dimensions:** Ø: 285mm D: 86mm  
**Lamp type:** LED 14W 4000K 1100lm  
**Construction:** Polycarbonate base - Opal diffuser

Code	Model	Qty
TPR14LED	14W LED Bulkhead	1
TPR14LEDS	14W LED c/w sensor	1
TPR14LEDEM	14W LED c/w emergency	1







TPR16WOHF



TPS28BOHF



TPR16BPHF



TPS28WPHF

**TPR16 ROUND BULKHEAD**

**Dimensions:** Ø: 200mm D: 80mm

**Lamp type:** 2D 16W4P 3500K - supplied

**Control gear:** HF soft start

**Construction:** Polycarbonate

Code	Model	Qty
TPR16WPHF	16W c/w Prismatic diffuser- white trim	1
TPR16BPHF	16W c/w Prismatic diffuser- black trim	1
TPR16WOHF	16W c/w Opal diffuser- white trim	1
TPR16BOHF	16W c/w Opal diffuser- black trim	1

**TPR28 ROUND BULKHEAD**

**Dimensions:** Ø: 285mm D: 80mm

**Lamp type:** 2D 28W4P 3500K - supplied

**Control gear:** HF soft start

**Control gear:** HF combined 3hr maintained emergency

**Construction:** Polycarbonate

Code	Model	Qty
TPR28WPHF	28W c/w Prismatic diffuser- white trim	1
TPR28BPHF	28W c/w Prismatic diffuser- black trim	1
TPR28WOHF	28W c/w Opal diffuser- white trim	1
TPR28BOHF	28W c/w Opal diffuser- black trim	1
TPR28WPEMHF	28W c/w Prismatic diffuser - white trim c/w emergency	1
TPR28WOEMHF	28W c/w Opal diffuser - white trim c/w emergency	1

**TPS28 SQUARE BULKHEAD**

**Dimensions:** 250mm x 250mm D: 80mm

**Lamp type:** 2D 28W4P 3500K - supplied

**Control gear:** HF soft start

**Construction:** Polycarbonate

Code	Model	Qty
TPS28WPHF	28W c/w Prismatic diffuser - white trim	1
TPS28BPHF	28W c/w Prismatic diffuser - black trim	1
TPS28WOHF	28W c/w Opal diffuser- white trim	1
TPS28BOHF	28W c/w Opal diffuser - black trim	1

**TPS28 SQUARE EMERGENCY BULKHEAD**

**Dimensions:** 250mm x 250mm D: 80mm

**Lamp type:** 2D 28W4P 3500K - supplied

**Control gear:** HF combined 3hr maintained emergency

**Construction:** Polycarbonate

Code	Model	Qty
TPS28WPEMHF	28W c/w Prismatic diffuser - white trim	1
TPS28BPEMHF	28W c/w Prismatic diffuser - black trim	1
TPS28WOEMHF	28W c/w Opal diffuser - white trim	1
TPS28BOEMHF	28W c/w Opal diffuser - black trim	1



Lamps not included unless otherwise stated

# BULKHEADS



## IP54 AMENITY LED BULKHEAD

LED

**Dimensions:** 250mm x 200mm D: 110mm

**Lamp supplied:** LED STBT

**Construction:** Polycarbonate.

Code	Model	Qty
AMLEDW	5W LED IP54 bulkhead - White / White Base	1
AMLEDB	5W LED IP54 bulkhead - White / Black Base	1
AMLEDR	5W LED IP54 bulkhead - Red / Black base	1



## BH22BC

**Dimensions:** L: 240mm W: 105mm D: 110mm

**Lamp type:** B22d 100W Max.

**Construction:** Aluminium trim polycarbonate prismatic diffuser

Code	Model	Qty
BH22BC	Aluminium c/w clear diffuser	1

## E27P

**Dimensions:** L: 240mm W: 105mm D: 110mm

**Lamp type:** E27 100W Max.

**Construction:** Aluminium trim polycarbonate prismatic diffuser

Code	Model	Qty
E27PC	Aluminium c/w clear diffuser	1
E27PR	Aluminium c/w red diffuser	1

## BH22PB

**Dimensions:** L: 240mm W: 105mm D: 110mm

**Lamp type:** B22d 60W Max.

**Construction:** Black polycarbonate trim, polycarbonate prismatic diffuser

Code	Model	Qty
BH22PB	Black c/w clear diffuser	1

## TPOV60

**Dimensions:** L: 210mm W: 100mm D: 110mm

**Lamp type:** E27 60W Max.

**Construction:** Die-cast aluminium, wire guard, glass diffuser

Code	Model	Qty
TPOV60W	White bulkhead	1
TPOV60B	Black bulkhead	1



BH22BC

E27PC

E27PR

BH22PB

Lamps not included unless otherwise stated



TPOV60W

TPOV60B

**Section Index**

IP44/65 LED Floodlights and Security Lighting	202
IP65 LED Floodlights	203-204
IP65 RGB Colour Changing LED Floodlights	204
Tungsten Halogen Floodlights	205
Floodlights and Utility Lighting	206
Wall Packs and Polycarbonate Floodlights	207
Floodlights, High Bays and Low Bays	208



P202

# IP44 AND IP65 LED FLOODLIGHTS AND SECURITY LIGHTING



FLS15BK



FLS15PBK



FLS30BK



FLS50PBK



FLS30PBK



LED

FLS15PBK

**Dimensions:** H: 181mm W: 115mm D: 88mm  
**Lamp type:** 15W SMD LED (non-replaceable)  
**Detection field:** 120° **Colour temp:** 6000K  
**Lumens:** 1200 **IP rating:** IP44  
**Construction:** Die-cast, lightweight aluminium body.

Code	Model	Qty
FLS15PBK	15W LED floodlight with PIR	1

FLS15BK

LED

**Dimensions:** H: 99mm W: 115mm D: 88mm  
**Lamp type:** 15W SMD LED (non-replaceable)  
**Colour temp:** 6000K **Lumens:** 1200  
**IP rating:** IP65 **Construction:** Die-cast, lightweight aluminium body.

Code	Model	Qty
FLS15BK	15W LED floodlight	1

FLS30BK

LED

**Dimensions:** H: 154mm W: 181mm D: 112mm  
**Lamp type:** 30W SMD LED (non-replaceable)  
**Colour temp:** 6000K **Lumens:** 2700  
**IP rating:** IP65 **Construction:** Die-cast, lightweight aluminium body.

Code	Model	Qty
FLS30BK	30W LED floodlight	1

FLS30PBK

LED

**Dimensions:** H: 216mm W: 181mm D: 112mm  
**Lamp type:** 30W SMD LED (non-replaceable)  
**Detection field:** 120° **Colour temp:** 6000K  
**Lumens:** 2700 **IP rating:** IP44  
**Construction:** Die-cast, lightweight aluminium body.

Code	Model	Qty
FLS30PBK	30W LED floodlight with PIR	1

FLS50PBK

LED

**Dimensions:** H: 256mm W: 223mm D: 135mm  
**Lamp type:** 50W SMD LED (non-replaceable)  
**Detection field:** 120° **Colour temp:** 6000K  
**Lumens:** 4800 **IP rating:** IP44  
**Construction:** Die-cast, lightweight aluminium body.

Code	Model	Qty
FLS50PBK	50W LED floodlight with PIR	1



## IP65 LED FLOODLIGHTS



FLS130BK



FLS50BK

LED

**Dimensions:** H: 196mm W: 223mm D: 135mm  
**Lamp type:** 50W SMD LED (non-replaceable)  
**Colour temp:** 6000K. **Lumens:** 4800  
**IP rating:** IP65 **Construction:** Die-cast aluminium

Code	Model	Qty
FLS50BK	50W LED floodlight	1



FLS70BK

FLS70BK

LED

**Dimensions:** H: 235mm W: 285mm D: 140mm  
**Lamp type:** 70W SMD LED (non-replaceable)  
**Colour temp:** 6000K. **Lumens:** 6700  
**IP rating:** IP65 **Construction:** Die-cast aluminium

Code	Model	Qty
FLS70BK	70W LED floodlight	1

FLS130BK

LED

**Dimensions:** H: 390mm W: 285mm D: 110mm  
**Lamp type:** 130W SMD LED (non-replaceable)  
**Colour temp:** 6000K. **Lumens:** 11600  
**IP rating:** IP65 **Construction:** Die-cast aluminium

Code	Model	Qty
FLS130BK	130W LED floodlight	1



FL80



FL80

LED

**Dimensions:** H: 292mm W: 255mm D: 92mm  
**Lamp type:** 80W SMD LED (non-replaceable)  
**Colour temp:** 4000K **Lumens:** 5500  
**IP rating:** IP65 **Construction:** Die-cast aluminium

Code	Model	Qty
FL80	80W IP65 LED floodlight	1

230V  
50Hz

IP  
65



## IP65 LED FLOODLIGHTS



**FLB15**



**FLB25**



**FLB50**



Extra  
slim  
profile

### FLB15

LED

**Dimensions:** H: 184mm W: 225mm D: 50mm

**Lamp type:** 15W SMD LED (non-replaceable)

**Colour temp:** 4000K **Lumens:** 1150

**IP rating:** IP65 **Construction:** Die-cast aluminium

Code	Model	Qty
FLB15	15W LED floodlight	1

### FLB25

LED

**Dimensions:** H: 232mm W: 287mm D: 55mm

**Lamp type:** 25W SMD LED (non-replaceable)

**Colour temp:** 4000K **Lumens:** 2000

**IP rating:** IP65 **Construction:** Die-cast aluminium

Code	Model	Qty
FLB25	25W LED floodlight	1

### FLB50

LED

**Dimensions:** H: 328mm W: 287mm D: 65mm

**Lamp type:** 49W SMD LED (non-replaceable)

**Colour temp:** 4000K **Lumens:** 4000

**IP rating:** IP65 **Construction:** Die-cast aluminium

Code	Model	Qty
FLB50	49W LED floodlight	1



## IP65 RGB COLOUR CHANGING LED FLOODLIGHTS



**FLE10RGBKB**  
/ **FLE20RGBKB**

**SPIKEXT**

### 10W COLOURCHANGE LED FLOODLIGHT

LED

**Dimensions:** H: 88mm W: 115mm D: 90mm

**Code** **Model** **Qty**

<b>FLE10RGBKB</b>	10W RGB colour changing LED floodlight with remote control	1
-------------------	------------------------------------------------------------	---

### 20W COLOURCHANGE LED FLOODLIGHT

LED

**Dimensions:** H: 139mm W: 180mm D: 115mm

**Code** **Model** **Qty**

<b>FLE20RGBKB</b>	20W RGB colour changing LED floodlight with remote control	1
-------------------	------------------------------------------------------------	---

### GROUND SPIKE

**Dimensions:** H:183mm, Ø:40mm

**Code** **Model** **Qty**

<b>SPIKEXT</b>	Optional ground spike	1
----------------	-----------------------	---



# TUNGSTEN HALOGEN FLOODLIGHTS AND SECURITY LIGHTING



**FL04BK**



**FL02W**



**FL10BK**



**OVFL02**



**FL01BK**

## FL04BK

**Dimensions:** W: 270mm H:200mm D:120mm

**Lamp type:** 1000W linear tungsten halogen

**Construction:** Die-cast aluminium

Code	Model	Qty
FL04BK	1000W black floodlight	1

## FL02

**Dimensions:** W: 180mm H:140mm D:180mm

**Lamp type:** 500W linear tungsten halogen

**Construction:** Die-cast aluminium

Code	Model	Qty
FL02W	500W white floodlight	1
FL02BK	500W black floodlight	1

## FL10BK

**Dimensions:** W: 140mm H:95mm D: 110mm

**Lamp type:** 150W linear tungsten halogen

**Construction:** Die-cast aluminium. c/w PIR sensor.

Detection range 12m at 2m height. Detection radius 160°. Timer: 30sec to 7mins.

Code	Model	Qty
FL10BK	150W black floodlight c/w PIR	1

## FL01BK

**Dimensions:** W: 140mm H:100mm D: 100mm

**Lamp type:** 150W linear tungsten halogen

**Construction:** Die-cast aluminium

Code	Model	Qty
FL01BK	150W black floodlight	1

## OVFL02

**Dimensions:** W: 180mm H:140mm D:120mm

**Lamp type:** 500W linear tungsten halogen

**Construction:** Die-cast aluminium

Code	Model	Qty
OVFL02	500W black floodlight	1

230V  
50Hz

IP  
54



All dimensions do not include bracket



**FL08A**



**OVFL08**

## FL08A

**Dimensions:** W: 186mm H:145mm D: 145mm

**Lamp type:** 500W linear tungsten halogen

**Construction:** Die-cast aluminium. c/w PIR sensor.

Detection range 12m at 2m height. Detection radius 160°. Timer: 30sec to 7mins. No manual override.

Code	Model	Qty
FL08A	500W black floodlight c/w PIR	1

## OVFL08

**Dimensions:** W: 180mm H:140mm D:120mm

**Lamp type:** 500W linear tungsten halogen

**Construction:** Die-cast aluminium. c/w PIR sensor.

Detection range 12m at 2m height. Detection radius 160°. Timer: 30sec to 7mins. No manual override.

Code	Model	Qty
OVFL08	500W black floodlight c/w PIR	1

230V  
50Hz

IP  
44



Lamps not included unless otherwise stated

## FLOODLIGHTS AND UTILITY LIGHTS



FL03BK

### FL03

**Dimensions:** W: 165mm H:220mm D:240mm

**Lamp type:** 300W linear tungsten halogen

**Construction:** Die-cast aluminium body.

Aluminium reflector

Code	Model	Qty
FL03BK	300W black floodlight	1

230V  
50Hz

IP  
33



## UTILITY LIGHTING



FL06BK

### FL06BK

**Dimensions:** W: 180mm H:140mm

**Lamp type:** 500W linear tungsten halogen

**Construction:** Die-cast aluminium. c/w wire guard. Switched independently by push button mounted on fitting. Free standing. Adjustable tilt

Code	Model	Qty
FL06BK	500W black free-standing task light	1

230V  
50Hz

IP  
54



### 110V TASK LIGHT

**Dimensions:** D: 120mm H:520mm L: 240mm

**Lamp type:** 2D 38W 6400K cool white - **supplied**

**Construction:** Robust polycarbonate body.

Clear polycarbonate diffuser. c/w 3m cable and 110V 16A plug.

Code	Model	Qty
TL110	110V 38W yellow task light	1

110V

IP  
44



### TL110



TL230

### 230V TASK LIGHT

**Dimensions:** D: 120mm H:520mm L: 240mm

**Lamp type:** 2D 38W 6400K cool white - **supplied**

**Construction:** Robust polycarbonate body.

Clear polycarbonate diffuser. c/w 3m cable and 230V 13A plug.

Code	Model	Qty
TL230	230V 38W black task light	1

230V  
50Hz

IP  
44



Lamps not included unless otherwise stated



# WALL PACK AND POLYCARBONATE FLOODLIGHTS

## TRW70 SON WALL PACKS

**Dimensions:** W 260mm x H 310mm H:185mm

**Lamp type:** E27 70W 2000k - **70WSONI**

**Construction:** Polycarbonate body. Symmetrical reflector. **Sensor model:** Internal photocell sensor: thermal photodiode dusk to dawn sensor. On: Min 20 lux. Off: Max 80 lux.

Code	Model	Qty
TRW70	70W Son wall pack	1
TRW70PC	70W Son wall pack c/w sensor	1

TRW70



## TRPC - HQI - PBT FLOODLIGHTS

**Dimensions:** W: 325mm H: 400mm D: 127mm

**Lamp type:** RX7 metal halide

**Control gear:** SON control gear

**Construction:** Polycarbonate body c/w stainless steel bracket for wall mounting. Symmetrical reflector. Ideal for coastal and high humidity areas.

Code	Model	Qty
TRPC70	70W Polycarbonate floodlight	1
TRPC150	150W Polycarbonate floodlight	1

TRPC150



## TRPC - SON-T - PBT FLOODLIGHTS

**Dimensions:** W: 420mm H: 450mm D: 170mm

**Lamp type:** E40 SON or E40 HQI-T

**Control gear:** SON control gear compatible with SON-T and HQI-T lamps.

**Construction:** Polycarbonate body c/w stainless steel bracket for wall mounting. Symmetrical reflector. Ideal for coastal and high humidity areas.

Code	Model	Qty
TRPC250	250W Polycarbonate floodlight	1
TRPC400	400W Polycarbonate floodlight	1

TRPC250

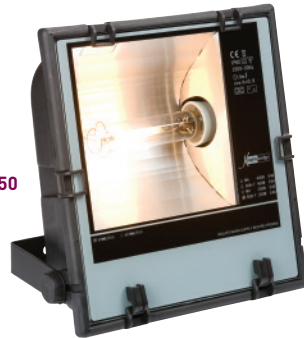

## TRHP70 SON FLOODLIGHTS

**Dimensions:** W 250mm x H 300mm D: 150mm

**Lamp type:** E27 70W 2000k - **70WSON-I**

**Construction:** Polycarbonate body c/w integral ignitor. Symmetrical reflector. **Sensor model:** Internal photocell sensor: thermal photodiode dusk to dawn sensor. On: Min 20 lux. Off: Max 80 lux. Bracket for wall mounting supplied.

Code	Model	Qty
TRHP70	70W Son floodlight	1
TRHP70PC	70W Son floodlight c/w sensor	1

TRHP70



Lamps not included unless otherwise stated

# FLOODLIGHTS, HIGH BAYS AND LOW BAYS



TR400SH



TR70HQI

## 250W/400W SON/HQI ALUMINIUM FLOODLIGHTS

**Dimensions:** W: 415mm H: 410mm D: 190mm

**Lamp:** SON-T and HQI-T

**Control gear:** SON control gear

**Construction:** Die-cast aluminium body c/w integral control gear and ignitor. Symmetrical reflector.

Bracket for wall mounting supplied.

Can use SON-T or Metal Halide E40 lamps.

Code	Model	Qty
TR250SH	250W Son HQI Floodlight	1
TR400SH	400W Son HQI Floodlight	1

## 70W/150W HQI ALUMINIUM FLOODLIGHTS

**Dimensions:** W: 240mm H: 350mm D: 170mm

**Lamp type:** RX7 70W / 150W 4000K

**Control gear:** SON control gear

**Construction:** Die-cast aluminium body c/w integral control gear and ignitor. Asymmetrical reflector.

Bracket for wall mounting supplied.

Code	Model	Qty
TR70HQI	70W HQI Floodlight	1
TR150HQI	150W HQI Floodlight	1

230V  
50Hz

IP  
54



TR250SLB

## 250W/400W SON/HQI LOW BAYS

**Dimensions:** L 590mm x W 280mm x D 150mm

**Lamp:** SON-T and HQI-T

**Control gear:** SON control gear

**Construction:** Powder coated sheet steel.

Toughened glass front cover. Symmetrical reflector

Code	Model	Qty
TR250SLB	250W low bay son HQI	1
TR400SLB	400W low bay son HQI	1



TR250HB

## 250W SON/HQI HIGH BAYS

**Dimensions:** Ø: 490mm H: 570mm

**Lamp type:** SON-E and HQI-E

**Control gear:** SON control gear

**Construction:** Integral control gear, glass front and chain eye supplied. Ceiling mounted. Integral ignitor within fitting. Aluminium reflector.

Code	Model	Qty
TR250HB	250W high bay son HQI	1

230V  
50Hz

IP  
20



230V  
50Hz

IP  
65



### Section Index

LED Emergency Exit Signs	230-231
Emergency Lighting	232-233
LED Emergency Floodlights	234



P232

# LED EMERGENCY EXIT SIGNS



EMEXIT



## EMEXIT

LED

**Dimensions:** L: 310mm H: 230mm D: 51mm

**Lamp type:** 2.5W LED 6000K

**Construction:** Lightweight, wall or ceiling mounted.

Legends available. Supplied as standard with arrow up. Integral 3hr emergency. Compatible for maintained or non-maintained use.

Code	Model	Qty
EMEXIT	3hr LED exit sign	1



## EMLSUS

LED

**Dimensions:** L: 300mm H: 700mm D: 45mm

**Lamp type:** 2W LED 6000K

**Construction:** Lightweight suspendable LED exit sign, ceiling mounted. Polycarbonate legends. Supplied as standard with arrow up. Integral 3hr emergency. Compatible for maintained or non-maintained use.

Code	Model	Qty
EMLSUS	3hr LED Exit sign	1



EMLSUS



## EMLREC

LED

**Dimensions:** L: 335mm H: 160mm D: 46mm

**Lamp type:** 2W SMD LED 6000K

**Construction:** Lightweight recessed LED exit sign, ceiling mounted. Polycarbonate legends. Supplied as standard with arrow up. Integral 3hr emergency. Compatible for maintained or non-maintained use.

Code	Model	Qty
EMLREC	3hr LED Exit sign	1



EMLREC



## LEGENDS

**Dimensions:** L: 300mm H: 156mm

Code	Model	Qty
LEMEXITLR	Left/right legend	1
EMEXITL2	Up legend	1
EMEXITL3	Down legend	1

Legends suitable for all above range of products

\*In sets of 2 - front/back.

# LED EMERGENCY EXIT SIGNS

## EMRUNN



### EMRUNN

LED

**Dimensions:** L: 395mm H: 190mm D:60mm

**Lamp type:** 6W LED

**Construction:** Lightweight, wall mounted metal frame with polycarbonate legends. Supplied as standard with arrow up. Integral 3hr emergency. Compatible for maintained or non-maintained use.

Code	Model	Qty
EMRUNN	3hr LED exit sign	1
EMRUNL	Left legend	1
EMRUNR	Right legend	1
EMRUND	Down legend	1
EMRUNU	Up legend	1

230V  
50Hz

IP  
20



## EMSWING



### EMSWING

LED

**Dimension:** L: 330mm W: 255mm D: 35mm

**Lamp type:** 4W LED

**Construction:** Matt aluminium. Supplied as standard with arrow up polycarbonate legend. Integral 3hr emergency. Compatible for maintained or non-maintained use with 1.5m suspension kit terminating in aluminium ceiling plate.

Code	Model	Qty
EMSWING	3hr LED exit sign	1
EMSWINGLR	Left/right legend	1
EMSWINGD	Down legend	1

230V  
50Hz

IP  
20



## EMERGENCY ARROW LEGEND DIRECTION

In the UK there are two current legal standards for emergency exit signs, The Health and Safety (Signs and Signals) Regulations / EC Safety Signs Directive (92/58/EEC) and ISO 7010 which was adopted by BS 5266:2011 (this is supported by EN 1838). BS 5499-4:2013 also now gives guidance for illuminated signs.

The only standard to give full guidance on the direction of arrows in emergency exit legends is the International Standard ISO 16069 which states that 'straight on' is depicted by an arrow facing up, something which is supported by BS 5499-4:2013. In line with UK and EU legislation all of our fixed emergency exit signs are supplied as arrow up. All other legends can be purchased separately where required.

For more information please consult the ICEL Technical statement TS03



# EMERGENCY LIGHTING

## EM8WNM

**Dimensions:** L: 345mm H: 76mm D:107mm

**Lamp type:** T5 8W 4000K

**Construction:** Polycarbonate body with metal hinged gear tray, lamp and legend kit. Integral 3hr emergency.

**Code**      **Model**      **Qty**

**EM8WNM**    3hr Non-maintained emergency light    1

**EM8WM**     3hr Maintained emergency light            1

230V  
50Hz

IP  
65



**EM8WNM**

Legend kit included with EM8WNM

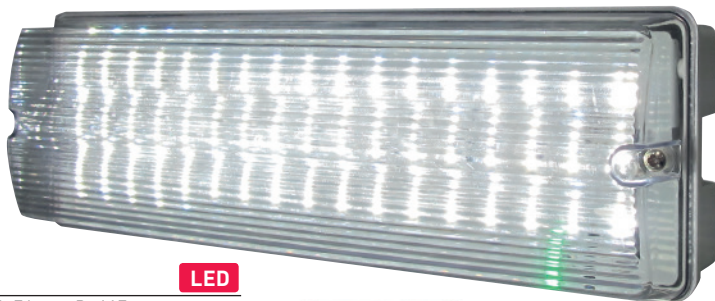

## EMLED1

**LED**

**Dimensions:** L: 352mm H: 76mm D: 117mm

**Lamp type:** 6W LED

**Construction:** Polycarbonate body c/w metal hinged gear tray, legend kit. Integral 3hr emergency. Compatible for maintained or non-maintained use.

**Code**      **Model**      **Qty**

**EMLED1**    3hr LED Emergency light                    1

230V  
50Hz

IP  
65



**EMLED1**

Legend kit included with EMLED1

## EMLED2

**LED**

**Dimensions:** L: 218mm H: 100mm D: 48mm

**Lamp type:** 3W LED

**Construction:** Polycarbonate body with metal hinged gear tray, lamp and legend kit. Integral 3hr emergency. Supplied with two diffusers.

**Code**      **Model**      **Qty**

**EMLED2**    3hr LED Emergency light                    1

230V  
50Hz

IP  
65



**EMLED2**

Legend kit included with EMLED2

# LED EMERGENCY LIGHTING

EMPOWER



## EMPOWER

LED

**Dimensions:** Ø: 40mm Cut out Ø: 34mm.

**Min void:** 250mm

**Lamp type:** 3W high output LED. Produces 5 lux at 2.7m

**Construction:** Aluminium body with aluminium and white bezels. Cool white LED. Green LED shows when light is in charging mode. Supplied pre-wired. Inverter and battery pack included.

For non-maintained use only.

Code	Model	Qty
EMPOWER	3hr Emergency LED downlight	1



EMPOWER2

## EMPOWER2

LED

**Dimensions:** Ø: 55mm Cut out Ø: 45mm.

**Lamp type:** 3W high output LED.

**Construction:** Aluminium body. Daylight 6000K LED. Separate green LED shows when light is in charging mode. Supplied pre-wired. Low profile inverter and battery pack included. Compatible for maintained or non-maintained use.

Code	Model	Qty
EMPOWER2	3hr Emergency LED downlight Daylight	1

EMPOWERW2	3hr Emergency LED downlight Warm white	1
-----------	----------------------------------------	---



ENM5

## ENM5

LED

**Dimensions:** Ø: 68mm Cut out Ø: 55mm.

**Lamp type:** 3W high output LED. Produces 5 lux at 2.7m

**Construction:** Aluminium body with aluminium and white bezels. Cool white LED. Green LED shows when light is in charging mode. Supplied pre-wired. Inverter and battery pack included.

For non-maintained use only.

Code	Model	Qty
ENM5	3hr Emergency LED downlight	1



## LED EMERGENCY FLOODLIGHTS



EMTWIN65

### EMTWIN65

LED

**Dimensions:** L: 296mm W: 272mm D: 75mm

**Lamp type:** 2 x 3W high output LEDs.

**Construction:** Polycarbonate case and spotlights.

High lumen output. Integral 3hr emergency.

For non-maintained use only.

Code	Model	Qty
EMTWIN65	3hr non-maintained Emergency floodlight	1

230V  
50Hz

IP  
65



EMTWIN

### EMTWIN

LED

**Dimensions:** L: 292mm W: 270mm D: 65mm

**Lamp type:** 2 x 3W high output LEDs.

**Construction:** Metal case. Polycarbonate diffusers.

Replacement for traditional twin halogen units.

Extremely long life, high lumens, low maintenance.

Integral 3hr emergency. For non-maintained use only.

Code	Model	Qty
EMTWIN	3hr non-maintained Emergency floodlight	1

230V  
50Hz

IP  
20

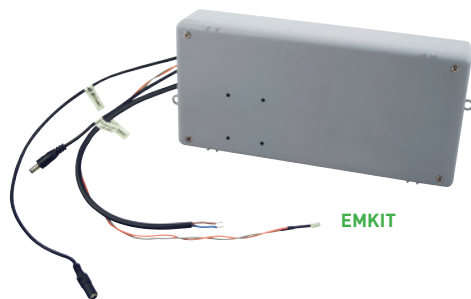

EMKIT

### EMKIT CONVERTER

**Dimensions:** L: 218mm W: 105mm D: 44mm

**Construction:** LED 3hr emergency kit. Converts most constant current LED luminaires to 3 hour emergency - 36V 50W max. Pre-wired for quick installation.

Adaptor leads included. Compatible for maintained or non-maintained use.

Code	Model	Qty
EMKIT	Pre-wired LED 3hr Emergency kit.	1

230V  
50Hz

IP  
20





## Section Index

LED Lamps	236-239
G4 and G9 Capsule Lamps	240
Lamps and Tubes	241-245
Transformers and Waterproof Junction Box	246
LED Drivers	247
Accessories	248
Essentials	249



P237



P238



P239

## LED LAMPS



**GUCOB7WW**

**GUCOB7CW**

**GUCOB7DL**

### 230V 7W DIMMABLE COB LED GU10

**LED**

**Description:** 230V 7W GU10 COB LED High Output COB LED technology. Alternative retrofit for the classic halogen GU10 lamp with a halogen feel. Low heat output. Ideal as retrofit for 50W Halogen in most applications. Dimmable. Size 50x56mm. 40° beam angle. CE EMC fully certified.

Code	Model	Lumens	Qty
<b>GUCOB7WW</b>	2700K Warm white	415 lm	20
<b>GUCOB7CW</b>	4000K Cool white	420 lm	20
<b>GUCOB7DL</b>	6000K Daylight	420 lm	20

### 230V AC 5W DIMMABLE COB LED GU10

**LED**

**Description:** 230V 5W GU10 COB LED High output LED technology GU10 halogen replacement. The lens creates an appearance of a halogen lamp. Low heat and high lumen output. Ideal as retrofit for halogen in most applications. Fully dimmable. CE EMC certified.

Code	Model	Lumens	Qty
<b>GUCOB5WW</b>	3000K Warm white	400 lm	10
<b>GUCOB5CW</b>	4000K Cool white	440 lm	10



**GUCOB5**



**MRCOB5**

### MR16 LED 5W COB LAMPS

**LED**

**Description:** MR16 12V AC/DC 5W COB LED. High output COB LED MR16. Retrofit alternative for 12V halogen lamp. The advanced lens creates an appearance of a halogen lamp. Low heat output. AC non-dimmable. Suitable for use with most AC low voltage transformers.

Code	Model	Lumens	Qty
<b>MRCOB5WW</b>	3000K Warm white	400 lm	10
<b>MRCOB5CW</b>	4000K Cool white	440 lm	10



**GU10COB3CW**

### 230V AC MAINS 4W COB LED GU10

**LED**

**Description:** GU10 base. 4W COB LED. Available in cool white 4000K, warm white 3000K. A-rated energy saving. Non-dimmable. CE EMC certified.

Code	Model	Lumens	Qty
<b>GU10COB3WW</b>	3000K Warm white	240 lm	10
<b>GU10COB3CW</b>	4000K Cool white	270 lm	10

**GUCR5DL****GUCR5WW****GUCR5CW****230V 5W NON-DIMMABLE COB LED GU10** **LED****Description:** 230V 5W GU10 COB LED**Description:** High output COB LED technology. Alternative retrofit and feel for the classic 50W halogen GU10 lamp. Low heat output. Non dimmable. Size 50x53mm. 40° beam angle. 3 year warranty. CE EMC fully certified.

Code	Model	Lumens	Qty
<b>GUCR5WW</b>	2700K Warm white	440 lm	20
<b>GUCR5CW</b>	4000K Cool white	450 lm	20
<b>GUCR5DL</b>	6000K Daylight	460 lm	20

**GUSM5WW****GUSM5CW****GUSM5DL****230V 5W NON-DIMMABLE LED GU10** **LED****Description:** High power 230V GU10 5W (24 x 3528 SMD) Very wide beam angle 120° Ideal retrofit replacement for existing GU10 halogen lamps. Huge electricity cost saving and long lifespan. Ceramic body / heat sink ideal for heat dissipation. Frosted glass lens. 3 Yr warranty. Non-dimmable. CE EMC fully certified.

Code	Model	Lumens	Qty
<b>GUSM5WW</b>	2700K Warm white	410 lm	20
<b>GUSM5CW</b>	4000K Cool white	450 lm	20
<b>GUSM5DL</b>	6000K Daylight	455 lm	20

**GUG5DL****GUG5WW****GUG5CW****230V 5W COB NON-DIMMABLE LED GU10** **LED****Description:** High output 230V GU10 COB LED technology. Replacement for the GU10 halogen 50W lamp. Ideal where a similar look and feel is required, the glass body makes the lamp aesthetically pleasing within a fitting. Beam angle 38°. 2 Year warranty. Non-dimmable CE EMC fully certified.

Code	Model	Lumens	Qty
<b>GUG5WW</b>	2700K Warm white	400 lm	20
<b>GUG5CW</b>	4000K Cool white	410 lm	20
<b>GUG5DL</b>	6000K Daylight	410 lm	20

# LED LAMPS



GLS6ESC



GLS6ESO



GLS6BCC



GLS6BCO



GB4BCC



GB4ESO



GB4SBCC



GB4BCO



GB4SESC



GB4SBCO



GB4SESO



GB4ESC



## 230V 6W LED GLS LAMPS Ø: 60mm

LED

6W GLS classic household lamps utilise LED filament technology. They are almost identical in appearance to a classic incandescent light bulb, producing a warm white (3000K) 360° light. Cool burning and long life, these lamps are ultra-efficient and reduce maintenance costs. 20,000 hrs. 2 year warranty. 6W similar to a 55W, 8W similar to 65W equivalent incandescent. 580-800 lumens. Non-dimmable

### CLEAR

Code	Model	Lumens	Qty
GLS6ESC	6W Clear LED GLS ES	620 lm	10
GLS6BCC	6W Clear LED GLS BC	620 lm	10
GLS8ESC	8W Clear LED GLS ES	800 lm	10
GLS8BCC	8W Clear LED GLS BC	800 lm	10

### FROSTED

Code	Model	Lumens	Qty
GLS6ESO	6W Frosted LED GLS ES	580 lm	10
GLS6BCO	6W Frosted LED GLS BC	580 lm	10
GLS8ESO	8W Frosted LED GLS ES	730 lm	10
GLS8BCO	8W Frosted LED GLS BC	730 lm	10

## 230V 4W LED GOLFBALL LAMPS Ø: 45mm

LED

4W golfball lamp utilises LED filament technology and is almost identical in appearance to a classic incandescent light bulb. Producing a warm white (3000K) 360° light. Cool burning and long life, this lamp is ultra-efficient and reduces maintenance costs. 20,000 hours, 2 year warranty, 400-420 lumens. Similar to a 40W incandescent. Non-dimmable.

### CLEAR

Code	Model	Lumens	Qty
GB4ESC	4W Clear LED golfball ES	420 lm	10
GB4BCC	4W Clear LED golfball BC	420 lm	10
GB4SBCC	4W Clear LED golfball SBC	420 lm	10
GB4SESC	4W Clear LED golfball SES	420 lm	10

### FROSTED

Code	Model	Lumens	Qty
GB4ESO	4W Frosted LED golfball ES	400 lm	10
GB4BCO	4W Frosted LED golfball BC	400 lm	10
GB4SBCO	4W Frosted LED golfball SBC	400 lm	10
GB4SESO	4W Frosted LED golfball SES	400 lm	10



## 230V 2W/4W LED CANDLE LAMPS Ø: 35mm LED

2W/4W candle lamp utilises LED filament technology and is almost identical in appearance to a classic incandescent light bulb. Producing a warm white (3000K) 360° light. Cool burning and long life, this lamp is ultra-efficient and reduces maintenance costs. 20,000 hours, 2 year warranty, 200-420 lumens. Non-dimmable.

2W equal to approx 25W, 4W equal to approx 40W.

### CLEAR LED

Code	Model	Lumens	Qty
CL2ESC	2W Clear LED candle ES	210 lm	10
CL2BCC	2W Clear LED candle BC	210 lm	10
CL2SBC	2W Clear LED candle SBC	210 lm	10
CL2SESC	2W Clear LED candle SES	210 lm	10

### FROSTED LED

Code	Model	Lumens	Qty
CL2ESO	2W Frosted LED candle ES	200 lm	10
CL2BCO	2W Frosted LED candle BC	200 lm	10
CL2SBCO	2W Frosted LED candle SBC	200 lm	10
CL2SESO	2W Frosted LED candle SES	200 lm	10

## CLEAR LED

Code	Model	Lumens	Qty
CL4ESC	4W Clear LED candle ES	420 lm	10
CL4BCC	4W Clear LED candle BC	420 lm	10
CL4SBC	4W Clear LED candle SBC	420 lm	10
CL4SESC	4W Clear LED candle SES	420 lm	10

## FLAME TIPPED CLEAR LED

Code	Model	Lumens	Qty
CLF4ESC	4W Clear LED flame tipped ES	420 lm	10
CLF4SESC	4W Clear LED flame tipped SES	420 lm	10

## FROSTED LED

Code	Model	Lumens	Qty
CL4ESO	4W Frosted LED candle ES	400 lm	10
CL4BCO	4W Frosted LED candle BC	400 lm	10
CL4SBCO	4W Frosted LED candle SBC	400 lm	10
CL4SESO	4W Frosted LED candle SES	400 lm	10

## G4 AND G9 CAPSULE LAMPS

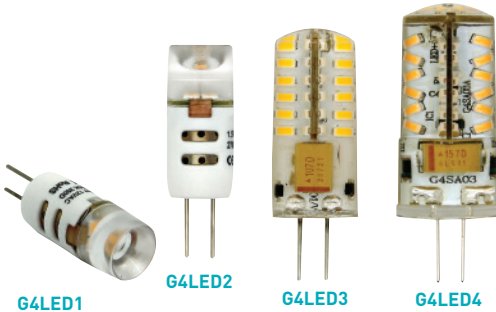

G4LED1

G4LED2

G4LED3

G4LED4

### 12V G4 BASE LED CAPSULE LAMPS

LED

**Description:** A range of 12V LED G4 capsule lamps. Suitable for use with AC and DC transformers. Non-dimmable

Code	Model	Qty
G4LED1	G4 LED 1.5W AC/DC 2700K 110 lm Dimensions: H: 33mm W:11mm	10
G4LED2	G4 LED 1.5W AC/DC 4000K 120 lm Dimensions: H: 33mm W:11mm	10
G4LED3	G4 LED 2W AC/DC 2700K 150 lm Dimensions: H: 37mm W: 13mm	10
G4LED4	G4 LED 3W AC/DC 2700K 200 lm Dimensions: H: 42mm W:16mm	10



LVL1

### 12V G4 BASE CAPSULE LAMPS

**Description:** G4 halogen capsule lamps. Colour temp: 3000K. Colour code: 830

Code	Model	Qty
LVL1	12V 10W - M91	20
LVL2	12V 20W - M47	20
LVL3	12V 50W - M32	20



G9LED10/11

G9LED6/7

G9LED8/9

### 230V G9 BASE LED CAPSULE LAMP

LED

**Description:** 230V G9 LED capsules. Suitable to replace most G9 halogen lamps (check size for suitability). Non-dimmable unless otherwise stated

Code	Model	Qty
G9LED6	G9 230V 4W LED capsule 2700K 220lm <b>Dimmable</b> Dimensions: H: 53mm W: 16mm	10
G9LED7	G9 230V 4W LED capsule 4000K 250lm <b>Dimmable</b> Dimensions: H: 53mm W: 16mm	10
G9LED8	G9 230V 4W LED capsule 2700K 370lm Dimensions: H: 50mm W: 16mm	10
G9LED9	G9 230V 4W LED capsule 4000K 370lm Dimensions: H: 50mm W: 16mm	10
G9LED10	G9 230V 2W LED capsule 2700K 200lm Dimensions: H: 48mm W: 16mm	10
G9LED11	G9 230V 2W LED capsule 4000K 200lm Dimensions: H: 48mm W: 16mm	10



G9-25W

### 230V G9 BASE ENERGY SAVER HALOGEN CAPSULE

**Description:** Colour temp: 3000K. Colour code: 830

Code	Model	Qty
G918W	230V Clear 18W	20
G928W	230V Clear 28W	20
G942W	230V Clear 42W	20

### G9 BASE TUNGSTEN DOUBLE FUSED HALOGEN LAMPS

**Description:** Colour temp: 3000K Colour code: 830

Code	Model	Qty
G9-25W	230V Clear 25W	20
G9-40W	230V Clear 40W	20
G9-60W	230V Clear 60W	20

L120

Tungsten halogen lamp range



## TUNGSTEN HALOGEN ENERGY SAVING LAMPS

Description: R7S Tungsten halogen lamps

Code	Model	Length	Qty
L80	80W 230V	78mm	50
L120	120W 230V	78mm	50
L110	500W 110V	118mm	50
L160	160W 230V	118mm	50
L230	230W 230V	118mm	50
L400	400W 230V	118mm	50
L1000	1000W 230V	189mm	50

HEOT1300W

Replacement 1300W tube for HEOD1309BK/W.



## OUTDOOR HEATER TUBE

Description: Quartz heater tubes

Code	Model	Length	Qty
HEOT1300W	Infrared tube	254mm	1

PL18W2P

PL9W2P



## PL LAMPS

Description: Colour temp: 4000K Colour code: 840  
Life: 5000 hours.

Code	Model	Base Type	Qty
PL9W2P	9W	2 pin G23-2pin	10
PL18W2P	18W	2 pin G24d-2	20
PL18W4P	18W	4 pin G24q-2	20
PL26W4P	26W	4 pin G24q-3	20
PL55W4P	55W	4 pin PL-L4pin	10

2D28W4P



## 2D WHITE ENERGY EFFICIENT LAMP

Description: Colour temp: 3500K Colour code: 835  
Life: 5000 hours.

Code	Model	Qty
2D16W2P	16W 2 pin	10
2D16W4P	16W 4 pin	10
2D28W2P	28W 2 pin	10
2D28W4P	28W 4 pin	10
2D38W4P	38W 4 pin	10

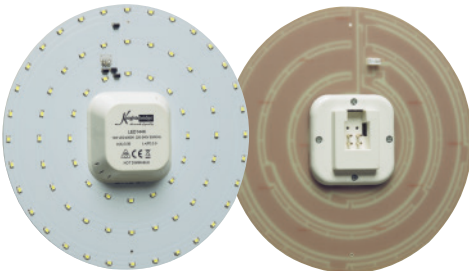

LED144K/146K

## 14W LED TRAY

LED

Description: LED 2D replacement lamps complete with built-in driver.

(Internal wiring of fitting may have to be modified to accept this lamp)

Code	Model	Qty
LED144K	14W LED tray 4000K 960 lm	1
LED146K	14W LED tray 6000K 1020 lm	1

# LAMPS

## GU10 1W LED LAMPS

LED

**Description:** (50mm closed) Life: 30,000 hours. For use in GU10 downlights.

Code	Model	Qty
GU10LEDW	White 21 LEDs	10
GU10LEDB	Blue 21 LEDs	10
GU10LEDY	Yellow 21 LEDs	10
GU10LEDR	Red 21 LEDs	10
GU10LEDG	Green 21 LEDs	10



GU10LED

## GU10 COLOUR CHANGE LED LAMP

LED

**Description:** GU10 red/green/blue sequential colour change

Code	Model	Qty
GU10LEDV	1W 50mm closed. 21 LEDs variable	10

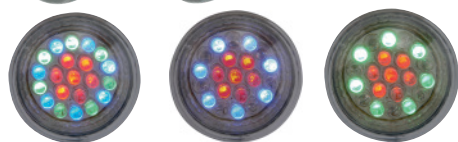

GU10LEDV



L25D

L59D



L58DR

L58DB



L59DAL



L58DL

## MR11-MR16 12V LAMPS

**Description:** Colour temp: 3000K Colour code: 830  
Life: 2000 hours. Closed dichroic lamps

Code	Model	Beam angle	Qty
L22D	35W MR11 35mm	30°	20
L25D	20W MR11 35mm	30°	20
L69D	20W MR16 50mm	38°	20
L81D	35W MR16 50mm	38°	20
L50D	50W MR16 50mm	24°	20
L58D	50W MR16 50mm	38°	20
L59D	50W MR16 50mm	60°	20

## MR16 12V COLOUR LAMPS

**Description:** Life: 2000 hours. Closed dichroic lamps

Code	Model	Beam angle	Qty
L58DB	50W MR16 50mm blue	38°	20
L58DR	50W MR16 50mm red	38°	20

## MR16 12V LAMPS

**Description:** Aluminium reflector. Colour temp: 3000K.  
Colour code: 830 Life: 2000 hours. Closed lamps

Code	Model	Beam angle	Qty
L58DAL	50W MR16 50mm	38°	20
L59DAL	50W MR16 50mm	60°	20
L69DAL	20W MR16 50mm	38°	20
L81DAL	35W MR16 50mm	38°	20

## MR16 LAMPS XENON LONG LIFE

**Description:** Xenon long life. Colour temp: 3000K.  
Colour code: 830 Life: 4000 hours. Closed lamps

Code	Model	Beam angle	Qty
L58DL	50W MR16 50mm	38°	20



## GU10 HALOGEN REFLECTOR LAMPS (50MM)

**Description:** 230V 50mm. Xenon long life: 3000 hours  
Colour temp: 3000K. Colour code: 830. Closed dichroic lamps

Code	Model	Beam angle	Qty
<b>GU10L</b>	50W Long life	40°	10
<b>GU10-35L</b>	35W Long life	40°	10

**Description:** Halogen reflector lamp Colour temp: 3000K. Colour code: 830  
Life: 2000 hours.

Code	Model	Beam angle	Qty
<b>GU10</b>	50W Aluminium reflector	40°	10
<b>GU10-25</b>	25W Aluminium reflector	40°	10
<b>GU10-35</b>	35W Aluminium reflector	40°	10



GU10-35

## PAR38 230V LAMPS

**Description:** 80W Lamps. ES (E27) fitting

Code	Model	Qty
<b>PAR3880B</b>	PAR38 80W E27 blue	1
<b>PAR3880Y</b>	PAR38 80W E27 yellow	1
<b>PAR3880R</b>	PAR38 80W E27 red	1
<b>PAR3880G</b>	PAR38 80W E27 green	1
<b>PAR3880W</b>	PAR38 80W E27 white	1
<b>PAR38120W</b>	PAR38 120W E27 white	1



PAR3880W



PAR3880G



PAR3880Y



PAR3880R



PAR3880B

# LAMPS

250WHQIE



70WSONI



250WHQIT



150WHQI



8800L



FLAME TIPPED

CANDLE

GLS

This range of lamps combines the versatility of halogen with the advantages of 30% energy savings. They are fully dimmable and available in GLS, candle and flame tipped.

## HALOGEN ENERGY SAVING LAMPS

**Description:** Candle, flame tipped and GLS energy saving lamps

Code	Model	Qty
HALO-C28BC	28W Candle BC clear lamp	10
HALO-C28SBC	28W Candle SBC clear lamp	10
HALO-C28SES	28W Candle SES clear lamp	10
HALO-C42BC	42W Candle BC clear lamp	10
HALO-C42SBC	42W Candle SBC clear lamp	10
HALO-C42SES	42W Candle SES clear lamp	10

## SON/ HQI LAMPS

**Description:** 70W SON/ HQI lamps

Code	Model	Colour	Qty
70WHQI	RX7 Metal halide double ended	4000K	1
70WSONI	E27 SON Elliptical with internal ignitor		1

## 150W

Code	Model	Colour	Qty
150WHQI	RX7 Metal halide double ended	4000K	1

## 250W

Code	Model	Colour	Qty
250WHQIE	E40 Metal halide elliptical	4000K	1
250WHQIT	E40 Metal halide tubular	4000K	1
250WSONT	E40 SON Tubular		1

## 400W

Code	Model	Colour	Qty
400WHQIT	E40 Metal halide tubular	4000K	1
400WSONT	E40 SON Tubular		1

## 7W NIGHT LIGHT

**Description:** Colour temperature: 3000K warm white

Code	Model	Qty
8800L	E12 7W	50

Code	Model	Qty
HALO-F28BC	28W Flame tipped BC clear lamp	10
HALO-F28SBC	28W Flame tipped SBC clear lamp	10
HALO-F28SES	28W Flame tipped SES clear lamp	10
HALO-F42BC	42W Flame tipped BC clear lamp	10
HALO-F42SBC	42W Flame tipped SBC clear lamp	10
HALO-F42SES	42W Flame tipped SES clear lamp	10

Code	Model	Qty
HALO-G28BC	28W GLS BC Clear lamp	10
HALO-G28ES	28W GLS ES Clear lamp	10
HALO-G42BC	42W GLS BC Clear lamp	10
HALO-G42ES	42W GLS ES Clear lamp	10
HALO-G70BC	70W GLS BC Clear lamp	10
HALO-G70ES	70W GLS ES Clear lamp	10

Energy-efficient, long life, cost effective alternative to classic T8 fluorescent lamps. Manufactured from shatterproof, robust polycarbonate. Instant ignition provides uniform illumination. Integral driver and mercury free components ensure safe environment. Non-dimmable. Ideally for use with Knightsbridge dedicated LED battens. However can be used with most prewired dedicated LED battens. Not for use with external electronic or magnetic ballasts.

## T8 LED TUBES

Code	Model	Length	Colour temp	Lumens	Qty
<b>T8LED4</b>	230V T8 20W LED tube	4ft	4000K	2350 lm	1
<b>T8LED4D</b>	230V T8 20W LED tube	4ft	6000K	2400 lm	1
<b>T8LED5</b>	230V T8 24W LED tube	5ft	4000K	2750 lm	1
<b>T8LED5D</b>	230V T8 24W LED tube	5ft	6000K	2900 lm	1
<b>T8LED6</b>	230V T8 30W LED tube	6ft	4000K	3350 lm	1
<b>T8LED6D</b>	230V T8 30W LED tube	6ft	6000K	3400 lm	1

SHOWN WITH BATTEN  
(NOT INCLUDED)

## T4 4000K TUBES

Replacement T4 4000K tubes.

Code	Model	Length	Qty
<b>T46TUBE*</b>	6W	220mm	25
<b>T46ATUBE</b>	6W	232mm	25
<b>T410TUBE</b>	10W	370mm	25
<b>T416TUBE</b>	16W	468mm	25
<b>T420TUBE</b>	20W	565mm	25
<b>T425TUBE</b>	25W	655mm	25
<b>T430TUBE</b>	30W	765mm	25

\* To fit previous T46 model (pre 2013)



## T4 TUBE RANGE

### ENERGY SAVING LAMP

**Description:** 9W energy saving lamp. For use with products CRFGX53 and TRIGX53.

Code	Model	Diameter	Qty
<b>GX53</b>	2700K CFL	75mm	1

## T5 3500K TUBES

Replacement T5 3500K tubes.

Code	Model	Length	Qty
<b>T56TUBE</b>	6W	225mm	25
<b>T58TUBE</b>	8W	300mm	25
<b>T514TUBE</b>	14W	565mm	25
<b>T521TUBE</b>	21W	862mm	25
<b>T528TUBE</b>	28W	1163mm	20
<b>T535TUBE</b>	35W	1463mm	10



## T5 TUBE RANGE



## 230V GU10 ENERGY EFFICIENT LAMPS

**Description:** Compact fluorescent lamps. Colour temperature: 2000K - 3000K warm white. Life: 6000 hours

Code	Model	Qty
<b>GU1011W</b>	11W	10
<b>GU1013W</b>	13W	10



# TRANSFORMERS AND WATERPROOF JUNCTION BOXES



T02

## TRANSFORMER T02

**Dimensions:** L: 120mm W: 30mm H: 23mm

**Description:** Dimmable, leaded, thermal overload and short circuit protection

Code	Model	Qty
T02	20 - 60W	1



T03

## TRANSFORMER T03

**Dimensions:** L: 120mm W: 38mm H: 29mm

**Description:** Dimmable, screw terminals thermal, overload and short circuit protection

Code	Model	Qty
T03	35W - 105W	1



T04

## TRANSFORMER T04

**Dimensions:** L: 184mm W: 45mm H: 45mm

**Description:** Dimmable, screw terminals thermal, overload and short circuit protection

Code	Model	Qty
T04	50-150W	1

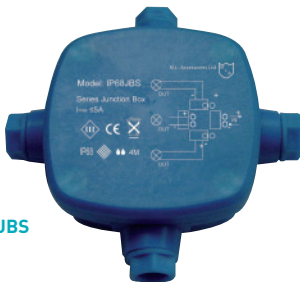

IP68JBS

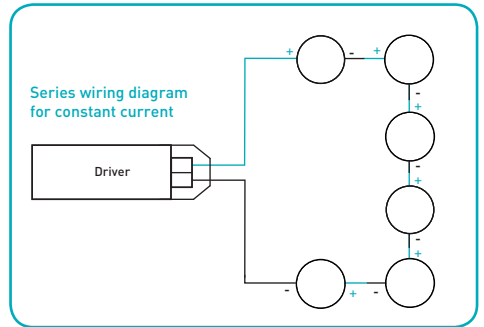

## IP68 WATERPROOF JUNCTION BOXES

**Description:** To be wired in series (refer to diagram).

Code	Model	Qty
IP68JBS	Max. load 48V DC 20W	1

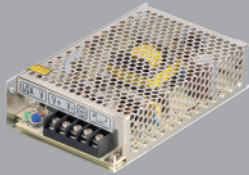

24DC150



12DC36



12DCIP36



12VDCA



1W350DA



36VDCA



24VDCA



1W350A

## 12V 12W LED DRIVER CONSTANT VOLTAGE

**Dimensions:** L: 98mm W: 39mm H: 22mm

**Description:** IP20 LED driver 12V  
12W constant voltage

Code	Model	Qty
12VDCA	12V 12W Constant voltage driver	1

## 24V 12W LED DRIVER CONSTANT VOLTAGE

**Dimensions:** L: 98mm W: 39mm H: 22mm

**Description:** IP20 LED driver 24V  
12W constant voltage

Code	Model	Qty
24VDCA	24V 12W Constant voltage driver	1

## 350mA 12W LED DRIVER CONSTANT CURRENT

**Dimensions:** L: 98mm W: 39mm H: 22mm

**Description:** IP20 LED driver 350mA  
12W constant current

Code	Model	Qty
1W350A	12W 350mA Constant current driver	1

## 350mA 12W LED DRIVER CONSTANT CURRENT DIMMABLE

**Dimensions:** L: 98mm W: 39mm H: 22mm

**Description:** IP20 LED driver 18-35V 350mA  
12W constant current.

Code	Model	Qty
1W350DA	12W 350mA Constant current driver Dimmable with most trailing edge dimmers.	1

## 12V 36W LED DRIVER CONSTANT VOLTAGE

**Dimensions:** L: 166mm W: 52mm H: 24mm

**Description:** IP20 LED driver 12V  
36W constant voltage

Code	Model	Qty
36VDCA	12V 36W Constant voltage driver	1

## 12V 36W IP67 DC LED DRIVER CONSTANT VOLTAGE

**Dimensions:** D: 20mm L: 220mm W: 28mm

**Description:** IP67 LED driver 12V 36W constant  
voltage 2m mains lead

Code	Model	Qty
12DCIP36	12V 36W IP67 Constant voltage driver	1

## 24V DC LED DRIVERS CONSTANT VOLTAGE

**Dimensions:** D: 37mm L: 160mm W: 96mm

**Description:** IP20 LED driver 24V Constant voltage.  
Requires suitable enclosure

Code	Model	Qty
24DC100	24V 100W DC Driver	1
24DC150	24V 150W DC Driver	1

## 12V 36W DC LED DRIVER CONSTANT VOLTAGE

**Dimensions:** D: 31mm L: 109mm W: 51mm

**Description:** IP20 LED driver 12V 36W  
constant voltage

Code	Model	Qty
12DC36	12V 36W Constant voltage driver	1

## ACCESSORIES

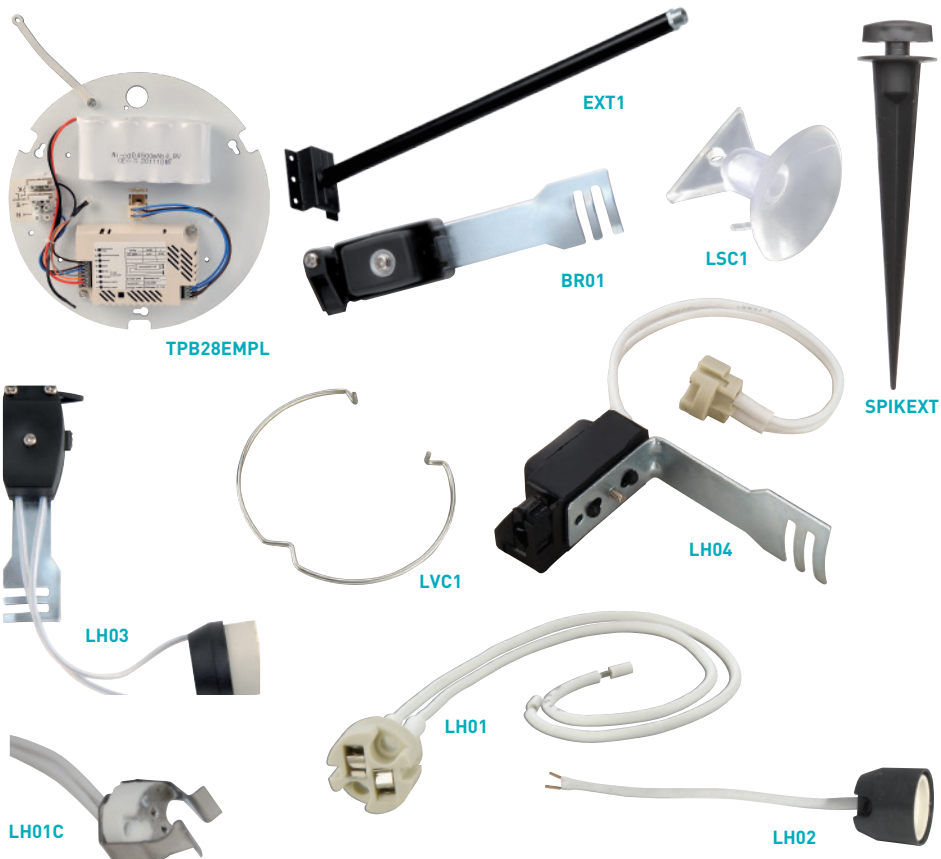

### BULKHEAD CONVERTER

Description:		
Code	Model	Qty
TPB28EMPL	Converts 28W TPB bulkheads into emergency versions	1

### RUBBER SUCTION CUP

Code	Model	Qty
LSC1	For easy changing of GU10 halogen lamps	10

### BRIDGE CONNECTOR

Code	Model	Qty
BR01	Bridge connector	50

### SPRING CLIPS FOR LOW VOLTAGE FITTINGS

Code	Model	Qty
LVC1	50mm	100
LVC2	35mm	100

### EXTENSION ARM

Description:		
Code	Model	Qty
EXT1	Thread: 20mm. Length of arm: 545mm For product FL03	1

### BLACK SPIKE

Code	Model	Qty
SPIKEXT	Black ground spike Can be used with floodlights (with certain brackets)	1

### LAMP HOLDERS

Code	Model	Qty
LH01	Low voltage c/w 180mm silicon cable	50
LH02	GU10 c/w 150mm silicon cable	50
LH03	GU10 c/w bridge and separate earth terminal	50
LH04	Low voltage c/w bridge	50
LH01C	Low voltage c/w 180mm silicon cable and metal clip	50

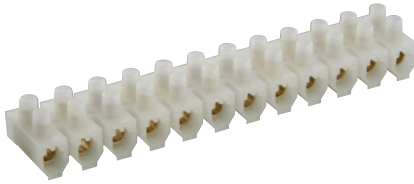

SC15A



MIXED FUSES



C-SCREW RANGE

1390



## STRIP CONNECTORS

Manufactured from self extinguishing flameproof polypropylene. Max. working temperature 125°C.

Conforms to low voltage directive 73/23/EEC & 93/68/EEC. Tested to EN 609981 & EN 6099821 CE marked.

Captive screws. Brass insert has deep lead in to allow easy cable entry.

Code	Model	Qty
SC3A	3A	10
SC5A	5A	10
SC15A	15A	10
SC30A	30A	10
SC60A	60A	10

## FUSES

Code	Model	Qty
3AFUSE	10 x 3A Packs	100
5AFUSE	10 x 5A Packs	100
13AFUSE	10 x 13A Packs	100
MIXEDFUSES	3 x 3A, 3 x 5A, 4 x 13A Packs	100

## SCREWS

Code	Model	Qty
C-SCREW35	M3.5 x 35mm	100
C-SCREW50	M3.5 x 50mm	100
C-SCREW75	M3.5 x 75mm	100
	(M3.5, steel, zinc plated, nickel plated or brass slotted screws)	
C-SCREW50B	M3.5 x 50mm Brass	100
C-SCREW50BK	M3.5 x 50mm Black Nickel	100
C-SCREW50N	M3.5 x 50mm Nickel Plated	100

## BLANKING PLUG

Code	Model	Qty
1390	Blanking plug for protection of unused sockets	5

## NIGHT LIGHTS

**LED**

Code	Finish	Qty
NL001	Plug in LED night light	1
NL002	Plug in LED night light with dual USB charger ports 5V DC 2.1A	1



# We're only a click away.

K-Direct is a quick and reliable home delivery service that provides next day delivery (across mainland UK) with a no minimum order value or quantity. Simply place your customer's order online and have it delivered direct on your behalf. Cut out the time spent double handling and order exactly what you want without having to order minimum product quantities. Don't let logistics stand in the way of you and our fantastic products - order with K-Direct and ensure a professional, fast and efficient delivery service.

- **No minimum order value**
- **No minimum box quantity**
- **Fast, efficient and professional**
- **Next day delivery (across mainland UK)**
- **Created for our wholesalers to satisfy their customers.**

Our newly redesigned responsive website ensures, however you access our products, your experience is quick and hassle free.



## Quality products, first class delivery





**K**nightsbridge®  
the mark of quality

**Index**

# A-Z INDEX

## NO. #

Code	Catalogue Section	Qty	Pg
1IPB	LED LIGHTING	1	222
1IPW	LED LIGHTING	1	222
1SPIKE38	OUTDOOR LIGHTING	1	214
1W350A	TRANSFORMERS/DRIVERS	1	247
1W350DA	TRANSFORMERS/DRIVERS	1	247
1WALL38	OUTDOOR LIGHTING	1	214
10GTOWER	TRAILING/EXTENSION SOCKETS	1	87
12DC36	TRANSFORMERS/DRIVERS	1	247
12DCIP36	TRANSFORMERS/DRIVERS	1	247
12GTOWER	TRAILING/EXTENSION SOCKETS	1	87
12VDCA	TRANSFORMERS/DRIVERS	1	247
13AFUSE	WIRING ACCESSORIES	100	249
132A	WIRING ACCESSORIES	20	89
135A	WIRING ACCESSORIES	20	89
1250	WIRING ACCESSORIES	20	85
1315A	WIRING ACCESSORIES	20	89
1350	WIRING ACCESSORIES	10	89
1375	WIRING ACCESSORIES	10	89
1381	WIRING ACCESSORIES	20	89
1382	WIRING ACCESSORIES	20	89
1383	WIRING ACCESSORIES	20	89
1383-BK	WIRING ACCESSORIES	20	89
1390	WIRING ACCESSORIES	5	249
150WHQI	LAMPS	1	244
20042M	TRAILING/EXTENSION SOCKETS	1	87
20043M	TRAILING/EXTENSION SOCKETS	1	87
2004S2M	TRAILING/EXTENSION SOCKETS	1	87
20062M	TRAILING/EXTENSION SOCKETS	1	87
2006S2M	TRAILING/EXTENSION SOCKETS	1	87
2013B	TRAILING/EXTENSION SOCKETS	10	88
2013W	TRAILING/EXTENSION SOCKETS	10	88
2014B	TRAILING/EXTENSION SOCKETS	10	88
2014W	TRAILING/EXTENSION SOCKETS	10	88
2121B	TRAILING/EXTENSION SOCKETS	10	88
2121W	TRAILING/EXTENSION SOCKETS	10	88
2135-RB	TRAILING/EXTENSION SOCKETS	20	88
2135-RW	TRAILING/EXTENSION SOCKETS	20	88
24DC100	TRANSFORMERS/DRIVERS	1	247
24DC150	TRANSFORMERS/DRIVERS	1	247
24VDCA	TRANSFORMERS/DRIVERS	1	247
250WHQIE	LAMPS	1	244
250WHQIT	LAMPS	1	244
250WSONT	LAMPS	1	244
2D16W2P	LAMPS	10	244
2D16W4P	LAMPS	10	241
2D28WZP	LAMP	10	241
2D28W4P	LAMPS	10	241
2D38W4P	LAMPS	10	241
2SPIKE38	OUTDOOR LIGHTING	1	214
2WALL38	OUTDOOR LIGHTING	1	214
316WALK	OUTDOOR LIGHTING	1	217
36VDCA	TRANSFORMERS/DRIVERS	1	247
3AFUSE	WIRING ACCESSORIES	100	249

Code	Catalogue Section	Qty	Pg
400WHQIT	LAMPS	1	244
400WSONT	LAMPS	1	244
4IPB	LED LIGHTING	1	222
4IPW	LED LIGHTING	1	222
5401A	OUTDOOR LIGHTING	1	227
5AFUSE	WIRING ACCESSORIES	100	249
5FTFLG	HIGH FREQUENCY MODULAR & FLUORESCENT FITTINGS	1	180
5FTFLW	HIGH FREQUENCY MODULAR & FLUORESCENT FITTINGS	1	180
5FTT5KIT	HIGH FREQUENCY MODULAR & FLUORESCENT FITTINGS	1	180
5FTT5WEMHF	HIGH FREQUENCY MODULAR & FLUORESCENT FITTINGS	1	180
5FTT5WHF	HIGH FREQUENCY MODULAR & FLUORESCENT FITTINGS	1	180
70WHQI	LAMPS	1	244
70WSONI	LAMPS	1	244
7100	TELEPHONE ACCESSORIES	10	78
7200	TELEPHONE ACCESSORIES	10	78
7300	TELEPHONE ACCESSORIES	10	78
7400	TELEPHONE ACCESSORIES	10	78
8200	WIRING ACCESSORIES	10	84
8210	WIRING ACCESSORIES	10	84
8220	WIRING ACCESSORIES	10	84
8230	WIRING ACCESSORIES	10	84
8250	WIRING ACCESSORIES	10	84
8260	WIRING ACCESSORIES	10	84
8261	WIRING ACCESSORIES	1	84
8270	WIRING ACCESSORIES	10	84
8280	WIRING ACCESSORIES	10	84
8290	WIRING ACCESSORIES	10	83
8300	WIRING ACCESSORIES	1	83
8300BC	WIRING ACCESSORIES	1	83
8300DIM	WIRING ACCESSORIES	1	83
8300PC	WIRING ACCESSORIES	1	83
8335D	WIRING ACCESSORIES	10	81
8370	WIRING ACCESSORIES	10	81
8375	WIRING ACCESSORIES	10	81
8380	WIRING ACCESSORIES	10	81
8380D	WIRING ACCESSORIES	10	81
8381	WIRING ACCESSORIES	10	81
8382	WIRING ACCESSORIES	10	81
8400	WIRING ACCESSORIES	10	85
8400B	WIRING ACCESSORIES	10	85
8410	WIRING ACCESSORIES	10	85
8410B	WIRING ACCESSORIES	10	85
8420	WIRING ACCESSORIES	10	85
8420B	WIRING ACCESSORIES	10	85
8430	WIRING ACCESSORIES	10	85
8430B	WIRING ACCESSORIES	10	85
8460	WIRING ACCESSORIES	10	85
8460B	WIRING ACCESSORIES	10	85
8470	WIRING ACCESSORIES	5	85
8470B	WIRING ACCESSORIES	5	85
8800L	LAMPS	50	244

Code	Catalogue Section	Qty	Pg
8910	WIRING ACCESSORIES	20	89
8GTOWER	TRAILING/EXTENSION SOCKETS	1	87

**A**

Code	Catalogue Section	Qty	Pg
AL131BC	LIGHTING PRODUCTS	1	158
AL132BC	LIGHTING PRODUCTS	1	158
AL133BC	LIGHTING PRODUCTS	1	158
AMLEDB	LED BULKHEADS	1	200
AMLEDR	LED BULKHEADS	1	200
AMLEDW	LED BULKHEADS	1	200
AV1	AV AUDIO VIDEO	10	76
AV2	AV AUDIO VIDEO	10	76
AV3	AV AUDIO VIDEO	10	76
AV4	AV AUDIO VIDEO	10	77
AV5	AV AUDIO VIDEO	10	77
AV6	AV AUDIO VIDEO	1	76
AV7	AV AUDIO VIDEO	1	76
AV8	AV AUDIO VIDEO	1	76

**B**

Code	Catalogue Section	Qty	Pg
BF1430	LED BULKHEADS	1	194
BF1430EM	LED BULKHEADS	1	194
BF1430EMS	LED BULKHEADS	1	194
BF1430S	LED BULKHEADS	1	194
BF14BBR	LED BULKHEADS	1	194
BF14BCHR	LED BULKHEADS	1	194
BF14BMS	LED BULKHEADS	1	194
BF14BWHT	LED BULKHEADS	1	194
BF14L4K	LED BULKHEADS	1	194
BF14L6K	LED BULKHEADS	1	194
BF2440	LED BULKHEADS	1	194
BF2440EM	LED BULKHEADS	1	194
BF2440EMS	LED BULKHEADS	1	194
BF2440S	LED BULKHEADS	1	194
BF24BBR	LED BULKHEADS	1	194
BF24BCHR	LED BULKHEADS	1	194
BF24BMS	LED BULKHEADS	1	194
BF24BWHT	LED BULKHEADS	1	194
BF24L4K	LED BULKHEADS	1	194
BF24L6K	LED BULKHEADS	1	194
BH22BC	BULKHEADS	1	200
BH22PB	BULKHEADS	1	200
BK4503	DATAComms ACCESSORIES	1	75
BK4505	DATAComms ACCESSORIES	1	75
BL01BK	OUTDOOR LIGHTING	1	223
BL01W	OUTDOOR LIGHTING	1	223
BL12LED	LED BULKHEADS	1	193
BL12LEDE	LED BULKHEADS	1	193
BL12LEDS	LED BULKHEADS	1	193
BL20LED	LED BULKHEADS	1	193
BL20LEDE	LED BULKHEADS	1	193
BL20LEDS	LED BULKHEADS	1	193
BR01	MISCELLANEOUS ACCESSORIES	50	248

Code	Catalogue Section	Qty	Pg
BT14	LED BULKHEADS	1	192
BT14CHR	LED BULKHEADS	1	192
BT14D	LED BULKHEADS	1	192
BT14DEM	LED LIGHTING	1	192
BT14DEMS	LED LIGHTING	1	192
BT14DS	LED BULKHEADS	1	192
BT14EM	LED BULKHEADS	1	192
BT14EMS	LED BULKHEADS	1	192
BT14S	LED BULKHEADS	1	191
BT20	LED BULKHEADS	1	192
BT20CHR	LED BULKHEADS	1	192
BT20D	LED BULKHEADS	1	192
BT20DEM	LED BULKHEADS	1	192
BT20DEMS	LED BULKHEADS	1	192
BT20DL	LED BULKHEADS	1	192
BT20DS	LED OUTDOOR	1	192
BT20EM	LED BULKHEADS	1	192
BT20EMS	LED BULKHEADS	1	192
BT20S	LED OUTDOOR	1	192

**C**

Code	Catalogue Section	Qty	Pg
C-SCREW35	WIRING ACCESSORIES	100	249
C-SCREW50	WIRING ACCESSORIES	100	249
C-SCREW50B	WIRING ACCESSORIES	100	249
C-SCREW50BK	WIRING ACCESSORIES	100	249
C-SCREW50N	WIRING ACCESSORIES	100	249
C-SCREW75	WIRING ACCESSORIES	100	249
CAPWGU	OUTDOOR LIGHTING	1	217
CENCON	LED STRIPS & FLEX	1	149
CENCONF	LED STRIPS & FLEX	1	149
CENCONS	LED STRIPS & FLEX	1	149
CH14GURCL	BATHROOM	1	167
CH14GURF	BATHROOM	1	167
CH15GUSCL	BATHROOM	1	167
CH15GUSF	BATHROOM	1	167
CL03C1	LIGHTING PRODUCTS	1	135
CL03CBR1	LIGHTING PRODUCTS	1	135
CL2BCC	LED LAMPS	10	239
CL2BCO	LED LAMPS	10	239
CL2ESC	LED LAMPS	10	239
CL2ESO	LED LAMPS	10	239
CL2SBCC	LED LAMPS	10	239
CL2SBCO	LED LAMPS	10	239
CL2SESC	LED LAMPS	10	239
CL2SESO	LED LAMPS	10	239
CL4BCC	LED LAMPS	10	239
CL4BCO	LED LAMPS	10	239
CL4ESC	LED LAMPS	10	239
CL4ESO	LED LAMPS	10	239
CL4SBCC	LED LAMPS	10	239
CL4SBCO	LED LAMPS	10	239
CL4SESC	LED LAMPS	10	239
CL4SESO	LED LAMPS	10	239

## A-Z INDEX

Code	Catalogue Section	Qty	Pg
CLF4ESC	LED LAMPS	10	239
CLF4SESC	LED LAMPS	10	239
CLG07C1	LIGHTING PRODUCTS	1	135
CLG07CBR1	LIGHTING PRODUCTS	1	135
CLG07W1	LIGHTING PRODUCTS	1	135
CLIP1	COMMERCIAL LIGHTING	20	189
CONDC	LED STRIPS & FLEX	1	149
CONIP	LED STRIPS & FLEX	1	149
CRF02B	LIGHTING PRODUCTS	1	144
CRF02C	LIGHTING PRODUCTS	1	144
CRF02CBR	LIGHTING PRODUCTS	1	144
CRF02W	LIGHTING PRODUCTS	1	144
CRF03B	LIGHTING PRODUCTS	1	143
CRF03C	LIGHTING PRODUCTS	1	143
CRF03CBR	LIGHTING PRODUCTS	1	143
CRF03W	LIGHTING PRODUCTS	1	143
CRFGX53B	LIGHTING PRODUCTS	1	144
CRFGX53C	LIGHTING PRODUCTS	1	144
CRFGX53CBR	LIGHTING PRODUCTS	1	144
CRFGX53W	LIGHTING PRODUCTS	1	144
CT3402BC	LIGHTING PRODUCTS	1	150
CT3402C	LIGHTING PRODUCTS	1	150
CT3522C	LIGHTING PRODUCTS	1	150
CT3525C	LIGHTING PRODUCTS	1	150

## D

Code	Catalogue Section	Qty	Pg
DC001	DOOR CHIMES	1	111
DC002	DOOR CHIMES	1	110
DC003	DOOR CHIMES	1	110
DC005	DOOR CHIMES	1	111
DC006	DOOR CHIMES	1	111
DC007	DOOR CHIMES	1	110
DC008	DOOR CHIMES	1	111
DEC1233C	BATHROOM	1	167
DEC1234C	BATHROOM	1	167
DGZ10B	LIGHTING PRODUCTS	20	136
DGZ10C	LIGHTING PRODUCTS	20	136
DGZ10CBR	LIGHTING PRODUCTS	20	136
DGZ10W	LIGHTING PRODUCTS	20	136
DT001	SENSORS	1	114
DT002	SENSORS	1	113
DT003	SENSORS	1	114
DT004	SENSORS	1	113
DT005	SENSORS	1	114
DT006	SENSORS	1	114
DT007	SENSORS	1	113

## E

Code	Catalogue Section	Qty	Pg
E27PC	BULKHEADS	1	200
E27PR	BULKHEADS	1	200
EB1	WIRING ACCESSORIES	10	85
EB2	WIRING ACCESSORIES	5	85
EG116	STEEL GALVANISED BOXES	20	82

Code	Catalogue Section	Qty	Pg
EG125	STEEL GALVANISED BOXES	10	82
EG135	STEEL GALVANISED BOXES	10	82
EG225	STEEL GALVANISED BOXES	5	82
EG235	STEEL GALVANISED BOXES	5	82
EM8WM	EMERGENCY LIGHTING	1	232
EM8WNM	EMERGENCY LIGHTING	1	232
EMEXIT	EMERGENCY LIGHTING	1	230
EMEXITL2	EMERGENCY LIGHTING	1	230
EMEXITL3	EMERGENCY LIGHTING	1	230
EMEXITLR	EMERGENCY LIGHTING	1	230
EMKIT	EMERGENCY LIGHTING	1	234
EMLED1	EMERGENCY LIGHTING	1	232
EMLED2	EMERGENCY LIGHTING	1	232
EMLREC	EMERGENCY LIGHTING	1	230
EMLSUS	EMERGENCY LIGHTING	1	230
EMPOWER	EMERGENCY LIGHTING	1	233
EMPOWER2	EMERGENCY LIGHTING	1	233
EMPOWERW2	EMERGENCY LIGHTING	1	233
EMRUN	EMERGENCY LIGHTING	1	231
EMRUND	EMERGENCY LIGHTING	1	231
EMRUNL	EMERGENCY LIGHTING	1	231
EMRUNR	EMERGENCY LIGHTING	1	231
EMRUNU	EMERGENCY LIGHTING	1	231
EMSWING	EMERGENCY LIGHTING	1	231
EMSWINGD	EMERGENCY LIGHTING	1	231
EMSWINGLR	EMERGENCY LIGHTING	1	231
EMTWIN	EMERGENCY LIGHTING	1	234
EMTWIN65	EMERGENCY LIGHTING	1	234
ENM5	EMERGENCY LIGHTING	1	233
EVOABF	FIRE-RATED DOWNLIGHTS AND ACCESSORIES	1	125
EVOABT	FIRE-RATED DOWNLIGHTS AND ACCESSORIES	1	126
EVOBCF	FIRE-RATED DOWNLIGHTS AND ACCESSORIES	1	125
EVOBCT	FIRE-RATED DOWNLIGHTS AND ACCESSORIES	1	126
EVOBKF	FIRE-RATED DOWNLIGHTS AND ACCESSORIES	1	125
EVOBKT	FIRE-RATED DOWNLIGHTS AND ACCESSORIES	1	126
EVOBRF	FIRE-RATED DOWNLIGHTS AND ACCESSORIES	1	125
EVOBRT	FIRE-RATED DOWNLIGHTS AND ACCESSORIES	1	126
EVOCHF	FIRE-RATED DOWNLIGHTS AND ACCESSORIES	1	125
EVOCHT	FIRE-RATED DOWNLIGHTS AND ACCESSORIES	1	126
EVOGMF	FIRE-RATED DOWNLIGHTS AND ACCESSORIES	1	125
EVOGMT	FIRE-RATED DOWNLIGHTS AND ACCESSORIES	1	126
EVOICF	FIRE-RATED DOWNLIGHTS AND ACCESSORIES	1	125
EVOICT	FIRE-RATED DOWNLIGHTS AND ACCESSORIES	1	126

<b>Code</b>	<b>Catalogue Section</b>	<b>Qty</b>	<b>Pg</b>
EVOIPBC	FIRE-RATED DOWNLIGHTS AND ACCESSORIES	1	125
EVOIPCH	FIRE-RATED DOWNLIGHTS AND ACCESSORIES	1	125
EVOIPWH	FIRE-RATED DOWNLIGHTS AND ACCESSORIES	1	125
EVOMWF	FIRE-RATED DOWNLIGHTS AND ACCESSORIES	1	125
EVOMWT	FIRE-RATED DOWNLIGHTS AND ACCESSORIES	1	126
EVOWHF	FIRE-RATED DOWNLIGHTS AND ACCESSORIES	1	125
EVOWHT	FIRE-RATED DOWNLIGHTS AND ACCESSORIES	1	126
EX001	VENTILATION	1	108
EX0010B	VENTILATION	1	109
EX0010T	VENTILATION	1	109
EX0010W	VENTILATION	1	109
EX001T	VENTILATION	1	108
EX002T	VENTILATION	1	108
EX003T	VENTILATION	1	108
EX004T	VENTILATION	1	108
EX007B	VENTILATION	1	109
EX007T	VENTILATION	1	109
EX007W	VENTILATION	1	109
EX008B	VENTILATION	1	109
EX008T	VENTILATION	1	109
EX008W	VENTILATION	1	109
EX009B	VENTILATION	1	109
EX009T	VENTILATION	1	109
EX009W	VENTILATION	1	109
EX4DUCT	VENTILATION	1	109
EX6DUCT	VENTILATION	1	109
EXT1	MISCELLANEOUS ACCESSORIES	1	248
EXT2	MISCELLANEOUS ACCESSORIES	1	212

**F**

<b>Code</b>	<b>Catalogue Section</b>	<b>Qty</b>	<b>Pg</b>
FL01BK	FLOODLIGHTS & SECURITY LIGHTING	1	205
FL02BK	FLOODLIGHTS & SECURITY LIGHTING	1	205
FL02W	FLOODLIGHTS & SECURITY LIGHTING	1	205
FL03BK	FLOODLIGHTS & SECURITY LIGHTING	1	206
FL04BK	FLOODLIGHTS & SECURITY LIGHTING	1	205
FL06BK	FLOODLIGHTS & SECURITY LIGHTING	1	206
FL08A	FLOODLIGHTS & SECURITY LIGHTING	1	205
FL10BK	FLOODLIGHTS & SECURITY LIGHTING	1	205
FL80	FLOODLIGHTS & SECURITY LIGHTING	1	203
FLB15	LED FLOOD AND SECURITY LIGHTING	1	204

<b>Code</b>	<b>Catalogue Section</b>	<b>Qty</b>	<b>Pg</b>
FLB25	LED FLOOD AND SECURITY LIGHTING	1	204
FLB50	LED FLOOD AND SECURITY LIGHTING	1	204
FLE10RGBKB	LED FLOOD AND SECURITY LIGHTING	1	204
FLE20RGBKB	LED FLOOD AND SECURITY LIGHTING	1	204
FLEXCON	LED STRIPS & FLEX	1	149
FLEXFIX	LED STRIPS & FLEX	1	149
FLS130BK	LED FLOOD AND SECURITY LIGHTING	1	203
FLS15BK	LED FLOOD AND SECURITY LIGHTING	1	202
FLS15PBK	LED FLOOD AND SECURITY LIGHTING	1	202
FLS30BK	LED FLOOD AND SECURITY LIGHTING	1	202
FLS30PBK	LED FLOOD AND SECURITY LIGHTING	1	202
FLS50BK	LED FLOOD AND SECURITY LIGHTING	1	203
FLS50PBK	LED FLOOD AND SECURITY LIGHTING	1	202
FLS70BK	LED FLOOD AND SECURITY LIGHTING	1	203
FP0100BB	FLAT PLATE	1	54
FP0100BC	FLAT PLATE	1	54
FP0100GM	FLAT PLATE	1	54
FP0100PB	FLAT PLATE	1	54
FP0100PC	FLAT PLATE	1	54
FP0100PL	FLAT PLATE	1	54
FP0140BB	FLAT PLATE	1	54
FP0140BC	FLAT PLATE	1	54
FP0140GM	FLAT PLATE	1	54
FP0140PB	FLAT PLATE	1	54
FP0140PC	FLAT PLATE	1	54
FP0140PL	FLAT PLATE	1	54
FP0150BB	FLAT PLATE	1	54
FP0150BC	FLAT PLATE	1	54
FP0150GM	FLAT PLATE	1	54
FP0150PB	FLAT PLATE	1	54
FP0150PC	FLAT PLATE	1	54
FP0150PL	FLAT PLATE	1	54
FP0160BB	FLAT PLATE	1	54
FP0160BC	FLAT PLATE	1	54
FP0160GM	FLAT PLATE	1	54
FP0160PB	FLAT PLATE	1	54
FP0160PC	FLAT PLATE	1	54
FP0160PL	FLAT PLATE	1	54
FP1100BB	FLAT PLATE	1	45
FP1100BC	FLAT PLATE	1	45
FP1100GM	FLAT PLATE	1	45
FP1100PB	FLAT PLATE	1	45
FP1100PC	FLAT PLATE	1	45
FP1100PL	FLAT PLATE	1	45
FP1200BB	FLAT PLATE	1	45

## A-Z INDEX

Code	Catalogue Section	Qty	Pg
FP1200PL	FLAT PLATE	1	45
FP1200BC	FLAT PLATE	1	45
FP1200GM	FLAT PLATE	1	45
FP1200PB	FLAT PLATE	1	45
FP1200PC	FLAT PLATE	1	45
FP1200PL	FLAT PLATE	1	45
FP12TOGBB	FLAT PLATE	1	48
FP12TOGBC	FLAT PLATE	1	48
FP12TOGGM	FLAT PLATE	1	48
FP12TOGPB	FLAT PLATE	1	48
FP12TOGPC	FLAT PLATE	1	48
FP12TOGPL	FLAT PLATE	1	48
FP1GBB	FLAT PLATE	1	57
FP1GBC	FLAT PLATE	1	57
FP1GGM	FLAT PLATE	1	57
FP1GPB	FLAT PLATE	1	57
FP1GPC	FLAT PLATE	1	57
FP1GPL	FLAT PLATE	1	57
FP1TOGBB	FLAT PLATE	1	48
FP1TOGBC	FLAT PLATE	1	48
FP1TOGGM	FLAT PLATE	1	48
FP1TOGPB	FLAT PLATE	1	48
FP1TOGPC	FLAT PLATE	1	48
FP1TOGPL	FLAT PLATE	1	48
FP2000BB	FLAT PLATE	1	45
FP2000BC	FLAT PLATE	1	45
FP2000GM	FLAT PLATE	1	45
FP2000PB	FLAT PLATE	1	45
FP2000PC	FLAT PLATE	1	45
FP2000PL	FLAT PLATE	1	45
FP2161BB	FLAT PLATE	1	47
FP2161BC	FLAT PLATE	1	47
FP2161GM	FLAT PLATE	1	47
FP2161PB	FLAT PLATE	1	47
FP2161PC	FLAT PLATE	1	47
FP2161PL	FLAT PLATE	1	47
FP2162BB	FLAT PLATE	1	47
FP2162BC	FLAT PLATE	1	47
FP2162GM	FLAT PLATE	1	47
FP2162PB	FLAT PLATE	1	47
FP2162PC	FLAT PLATE	1	47
FP2162PL	FLAT PLATE	1	47
FP2163BB	FLAT PLATE	1	47
FP2163BC	FLAT PLATE	1	47
FP2163GM	FLAT PLATE	1	47
FP2163PB	FLAT PLATE	1	47
FP2163PC	FLAT PLATE	1	47
FP2163PL	FLAT PLATE	1	47
FP2164BB	FLAT PLATE	1	47
FP2164BC	FLAT PLATE	1	47
FP2164GM	FLAT PLATE	1	47
FP2164PB	FLAT PLATE	1	47
FP2164PC	FLAT PLATE	1	47
FP2164PL	FLAT PLATE	1	47

Code	Catalogue Section	Qty	Pg
FP2GBB	FLAT PLATE	1	57
FP2GBC	FLAT PLATE	1	57
FP2GGM	FLAT PLATE	1	57
FP2GPB	FLAT PLATE	1	57
FP2GPC	FLAT PLATE	1	57
FP2GPL	FLAT PLATE	1	57
FP2TOGBB	FLAT PLATE	1	48
FP2TOGBC	FLAT PLATE	1	48
FP2TOGGM	FLAT PLATE	1	48
FP2TOGPB	FLAT PLATE	1	48
FP2TOGPC	FLAT PLATE	1	48
FP2TOGPL	FLAT PLATE	1	48
FP3000BB	FLAT PLATE	1	45
FP3000BC	FLAT PLATE	1	45
FP3000GM	FLAT PLATE	1	45
FP3000PB	FLAT PLATE	1	45
FP3000PC	FLAT PLATE	1	45
FP3000PL	FLAT PLATE	1	45
FP3TOGBB	FLAT PLATE	1	49
FP3TOGBC	FLAT PLATE	1	49
FP3TOGGM	FLAT PLATE	1	49
FP3TOGPB	FLAT PLATE	1	49
FP3TOGPC	FLAT PLATE	1	49
FP3TOGPL	FLAT PLATE	1	49
FP4000BB	FLAT PLATE	1	46
FP4000BC	FLAT PLATE	1	46
FP4000GM	FLAT PLATE	1	46
FP4000PB	FLAT PLATE	1	46
FP4000PC	FLAT PLATE	1	46
FP4000PL	FLAT PLATE	1	46
FP4100BB	FLAT PLATE	1	46
FP4100BC	FLAT PLATE	1	46
FP4100GM	FLAT PLATE	1	46
FP4100PB	FLAT PLATE	1	46
FP4100PC	FLAT PLATE	1	46
FP4100PL	FLAT PLATE	1	46
FP4200BB	FLAT PLATE	1	46
FP4200BC	FLAT PLATE	1	46
FP4200GM	FLAT PLATE	1	46
FP4200PB	FLAT PLATE	1	46
FP4200PC	FLAT PLATE	1	46
FP4200PL	FLAT PLATE	1	46
FP4GBB	FLAT PLATE	1	57
FP4GBC	FLAT PLATE	1	57
FP4GGM	FLAT PLATE	1	57
FP4GPB	FLAT PLATE	1	57
FP4GPC	FLAT PLATE	1	57
FP4GPL	FLAT PLATE	1	57
FP4TOGBB	FLAT PLATE	1	49
FP4TOGBC	FLAT PLATE	1	49
FP4TOGGM	FLAT PLATE	1	49
FP4TOGPB	FLAT PLATE	1	49
FP4TOGPC	FLAT PLATE	1	49
FP4TOGPL	FLAT PLATE	1	49

<b>Code</b>	<b>Catalogue Section</b>	<b>Qty</b>	<b>Pg</b>
FP5ABB	FLAT PLATE	1	43
FP5ABC	FLAT PLATE	1	43
FP5ABCW	FLAT PLATE	1	43
FP5AGM	FLAT PLATE	1	43
FP5APB	FLAT PLATE	1	43
FP5APC	FLAT PLATE	1	43
FP5APCW	FLAT PLATE	1	43
FP5APLW	FLAT PLATE	1	43
FP6000BB	FLAT PLATE	1	50
FP6000BC	FLAT PLATE	1	50
FP6000GM	FLAT PLATE	1	50
FP6000NBB	FLAT PLATE	1	50
FP6000NBC	FLAT PLATE	1	50
FP6000NGM	FLAT PLATE	1	50
FP6000NPB	FLAT PLATE	1	50
FP6000NPC	FLAT PLATE	1	50
FP6000NPL	FLAT PLATE	1	50
FP6000PB	FLAT PLATE	1	50
FP6000PC	FLAT PLATE	1	50
FP6000PL	FLAT PLATE	1	50
FP6300BB	FLAT PLATE	1	50
FP6300BC	FLAT PLATE	1	50
FP6300FBB	FLAT PLATE	1	50
FP6300FBC	FLAT PLATE	1	50
FP6300FGM	FLAT PLATE	1	50
FP6300FPB	FLAT PLATE	1	50
FP6300FPC	FLAT PLATE	1	50
FP6300FPL	FLAT PLATE	1	50
FP6300GM	FLAT PLATE	1	50
FP6300NBB	FLAT PLATE	1	50
FP6300NBC	FLAT PLATE	1	50
FP6300NGM	FLAT PLATE	1	50
FP6300NPB	FLAT PLATE	1	50
FP6300NPC	FLAT PLATE	1	50
FP6300NPL	FLAT PLATE	1	50
FP6300PB	FLAT PLATE	1	50
FP6300PC	FLAT PLATE	1	50
FP6300PL	FLAT PLATE	1	50
FP7000BB	FLAT PLATE	1	40
FP7000BC	FLAT PLATE	1	40
FP7000BCW	FLAT PLATE	1	40
FP7000GM	FLAT PLATE	1	40
FP7000PB	FLAT PLATE	1	40
FP7000PC	FLAT PLATE	1	40
FP7000PCW	FLAT PLATE	1	40
FP7000PLW	FLAT PLATE	1	40
FP7300BB	FLAT PLATE	1	53
FP7300BC	FLAT PLATE	1	53
FP7300GM	FLAT PLATE	1	53
FP7300PB	FLAT PLATE	1	53
FP7300PC	FLAT PLATE	1	53
FP7300PL	FLAT PLATE	1	53
FP7400BB	FLAT PLATE	1	53
FP7400BC	FLAT PLATE	1	53
FP7400GM	FLAT PLATE	1	53

<b>Code</b>	<b>Catalogue Section</b>	<b>Qty</b>	<b>Pg</b>
FP7400PB	FLAT PLATE	1	53
FP7400PC	FLAT PLATE	1	53
FP7400PL	FLAT PLATE	1	53
FP7UBBW	FLAT PLATE	1	44
FP7UBCW	FLAT PLATE	1	44
FP7UPBW	FLAT PLATE	1	44
FP7UPCW	FLAT PLATE	1	44
FP7USB4BB	FLAT PLATE	1	42
FP7USB4BC	FLAT PLATE	1	42
FP7USB4BCW	FLAT PLATE	1	42
FP7USB4GM	FLAT PLATE	1	42
FP7USB4PB	FLAT PLATE	1	42
FP7USB4PC	FLAT PLATE	1	42
FP7USB4PCW	FLAT PLATE	1	42
FP7USB4PLW	FLAT PLATE	1	42
FP8331NBB	FLAT PLATE	1	52
FP8331NBC	FLAT PLATE	1	52
FP8331NGM	FLAT PLATE	1	52
FP8331NPB	FLAT PLATE	1	52
FP8331NPC	FLAT PLATE	1	52
FP8331NPL	FLAT PLATE	1	52
FP8332NBB	FLAT PLATE	1	52
FP8332NBC	FLAT PLATE	1	52
FP8332NGM	FLAT PLATE	1	52
FP8332NPB	FLAT PLATE	1	52
FP8332NPC	FLAT PLATE	1	52
FP8332NPL	FLAT PLATE	1	52
FP8333NBB	FLAT PLATE	1	52
FP8333NBC	FLAT PLATE	1	52
FP8333NBCW	FLAT PLATE	1	52
FP8333NGM	FLAT PLATE	1	52
FP8333NPB	FLAT PLATE	1	52
FP8333NPC	FLAT PLATE	1	52
FP8333NPCW	FLAT PLATE	1	52
FP8333NPLW	FLAT PLATE	1	52
FP8341BB	FLAT PLATE	1	51
FP8341BC	FLAT PLATE	1	51
FP8341FBB	FLAT PLATE	1	51
FP8341FBC	FLAT PLATE	1	51
FP8341FGM	FLAT PLATE	1	51
FP8341FPB	FLAT PLATE	1	51
FP8341FPC	FLAT PLATE	1	51
FP8341FPL	FLAT PLATE	1	51
FP8341GM	FLAT PLATE	1	51
FP8341NBB	FLAT PLATE	1	51
FP8341NBC	FLAT PLATE	1	51
FP8341NGM	FLAT PLATE	1	51
FP8341NPB	FLAT PLATE	1	51
FP8341NPC	FLAT PLATE	1	51
FP8341NPL	FLAT PLATE	1	51
FP8341PB	FLAT PLATE	1	51
FP8341PC	FLAT PLATE	1	51
FP8341PL	FLAT PLATE	1	51
FP8350BB	FLAT PLATE	1	56
FP8350BC	FLAT PLATE	1	56

## A-Z INDEX

Code	Catalogue Section	Qty	Pg
FP8350GM	FLAT PLATE	1	56
FP8350PB	FLAT PLATE	1	56
FP8350PC	FLAT PLATE	1	56
FP8350PL	FLAT PLATE	1	56
FP8360BB	FLAT PLATE	1	56
FP8360BC	FLAT PLATE	1	56
FP8360GM	FLAT PLATE	1	56
FP8360PB	FLAT PLATE	1	56
FP8360PC	FLAT PLATE	1	56
FP8360PL	FLAT PLATE	1	56
FP8900BB	FLAT PLATE	1	55
FP8900BC	FLAT PLATE	1	55
FP8900BCW	FLAT PLATE	1	55
FP8900GM	FLAT PLATE	1	55
FP8900PB	FLAT PLATE	1	55
FP8900PC	FLAT PLATE	1	55
FP8900PCW	FLAT PLATE	1	55
FP8900PLW	FLAT PLATE	1	55
FP9000BB	FLAT PLATE	1	40
FP9000BC	FLAT PLATE	1	40
FP9000BCW	FLAT PLATE	1	40
FP9000GM	FLAT PLATE	1	40
FP9000PB	FLAT PLATE	1	40
FP9000PC	FLAT PLATE	1	40
FP9000PCW	FLAT PLATE	1	40
FP9000PLW	FLAT PLATE	1	40
FP9901BB	FLAT PLATE	1	41
FP9901BC	FLAT PLATE	1	41
FP9901BCW	FLAT PLATE	1	41
FP9901GM	FLAT PLATE	1	41
FP9901PB	FLAT PLATE	1	41
FP9901PC	FLAT PLATE	1	41
FP9901PCW	FLAT PLATE	1	41
FP9901PLW	FLAT PLATE	1	41
FP9902BB	FLAT PLATE	1	42
FP9902BC	FLAT PLATE	1	42
FP9902BCW	FLAT PLATE	1	42
FP9902GM	FLAT PLATE	1	42
FP9902PB	FLAT PLATE	1	42
FP9902PC	FLAT PLATE	1	42
FP9902PCW	FLAT PLATE	1	42
FP9902PLW	FLAT PLATE	1	42
FP9UBBW	FLAT PLATE	1	44
FP9UBCW	FLAT PLATE	1	44
FP9UPBW	FLAT PLATE	1	44
FP9UPCW	FLAT PLATE	1	44
FPQUADBB	FLAT PLATE	1	41
FPQUADBC	FLAT PLATE	1	41
FPQUADBCW	FLAT PLATE	1	41
FPQUADGM	FLAT PLATE	1	41
FPQUADPB	FLAT PLATE	1	41
FPQUADPC	FLAT PLATE	1	41
FPQUADPCW	FLAT PLATE	1	41
FPQUADPLW	FLAT PLATE	1	41

Code	Catalogue Section	Qty	Pg
FPRJ45BB	FLAT PLATE	1	53
FPRJ45BC	FLAT PLATE	1	53
FPRJ45GM	FLAT PLATE	1	53
FPRJ45PB	FLAT PLATE	1	53
FPRJ45PC	FLAT PLATE	1	53
FPRJ45PL	FLAT PLATE	1	53
FR1200	FIRE-RATED DOWNLIGHTS AND ACCESSORIES	1	175
FR150	FIRE-RATED DOWNLIGHTS AND ACCESSORIES	1	136
FR600	FIRE-RATED DOWNLIGHTS AND ACCESSORIES	1	175

## G

Code	Catalogue Section	Qty	Pg
G4LED1	LED LAMPS	10	240
G4LED2	LED LAMPS	10	240
G4LED3	LED LAMPS	10	240
G4LED4	LED LAMPS	10	240
G9-25W	LAMPS	20	240
G9-40W	LAMPS	20	240
G9-60W	LAMPS	20	240
G918W	LAMPS	20	240
G928W	LAMPS	20	240
G942W	LAMPS	20	240
G9LED10	LED LAMPS	10	240
G9LED11	LED LAMPS	10	240
G9LED6	LED LAMPS	10	240
G9LED7	LED LAMPS	10	240
G9LED8	LED LAMPS	10	240
G9LED9	LED LAMPS	10	240
GB4BCC	LED LAMPS	10	238
GB4BCO	LED LAMPS	10	238
GB4ESC	LED LAMPS	10	238
GB4ESO	LED LAMPS	10	238
GB4SBCC	LED LAMPS	10	238
GB4SBCO	LED LAMPS	10	238
GB4SESC	LED LAMPS	10	238
GB4SESO	LED LAMPS	10	238
GLS6BCC	LED LAMPS	10	238
GLS6BCO	LED LAMPS	10	238
GLS6ESC	LED LAMPS	10	238
GLS6ESO	LED LAMPS	10	238
GLS8BCC	LED LAMPS	10	238
GLS8BCO	LED LAMPS	10	238
GLS8ESC	LED LAMPS	10	238
GLS8ESO	LED LAMPS	10	238
GROUND1	OUTDOOR LIGHTING	1	215
GROUND2	OUTDOOR LIGHTING	1	215
GU10	LAMPS	10	243
GU10-25	LAMPS	10	243
GU10-35	LAMPS	10	243
GU10-35L	LAMPS	10	243
GU1011W	LAMPS	10	245
GU10COB3CW	LED LAMPS	10	236



<b>Code</b>	<b>Catalogue Section</b>	<b>Qty Pg</b>
GU10COB3WW	LED LAMPS	10 236
GU10L	LAMPS	10 243
GU10LEDB	LED LAMPS	10 242
GU10LEDG	LED LAMPS	10 242
GU10LEDR	LED LAMPS	10 242
GU10LEDV	LED LAMPS	10 242
GU10LEDW	LED LAMPS	10 242
GU10LEDY	LED LAMPS	10 242
GU10SPIKE	OUTDOOR LIGHTING	1 212
GU10SPIKEBK	OUTDOOR LIGHTING	1 212
GU10SPIKEL	OUTDOOR LIGHTING	1 212
GUCOB5CW	LED LAMPS	10 236
GUCOB5WW	LED LAMPS	10 236
GUCOB7CW	LED LAMPS	20 236
GUCOB7DL	LED LAMPS	20 236
GUCOB7WW	LED LAMPS	20 236
GUCR5CW	LED LAMPS	20 237
GUCR5DL	LED LAMPS	20 237
GUCR5WW	LED LAMPS	20 237
GUG5CW	LED LAMPS	20 237
GUG5DL	LED LAMPS	20 237
GUG5WW	LED LAMPS	20 237
GUSM5CW	LED LAMPS	20 237
GUSM5DL	LED LAMPS	20 237
GUSM5WW	LED LAMPS	20 237
GX53	LAMPS	1 245

**H**

<b>Code</b>	<b>Catalogue Section</b>	<b>Qty Pg</b>
HALO-C28BC	LAMPS	10 244
HALO-C28SBC	LAMPS	10 244
HALO-C28SES	LAMPS	10 244
HALO-C42BC	LAMPS	10 244
HALO-C42SBC	LAMPS	10 244
HALO-C42SES	LAMPS	10 244
HALO-F28BC	LAMPS	10 244
HALO-F28SBC	LAMPS	10 244
HALO-F28SES	LAMPS	10 244
HALO-F42BC	LAMPS	10 244
HELO-F42SBC	LAMPS	10 244
HALO-F42SES	LAMPS	10 244
HALO-G28BC	LAMPS	10 244
HALO-G28ES	LAMPS	10 244
HALO-G42BC	LAMPS	10 244
HALO-G42ES	LAMPS	10 244
HALO-G70BC	LAMPS	10 244
HALO-G70ES	LAMPS	10 244
HCB	LIGHTING PRODUCTS	1 135
HCBC	LIGHTING PRODUCTS	1 135
HCC	LIGHTING PRODUCTS	1 135
HCW	LIGHTING PRODUCTS	1 135
HEOD1309BK	HEATERS (OUTDOOR)	1 227
HEOD1309W	HEATERS (OUTDOOR)	1 227
HEOT1300W	LAMPS	1 227

<b>Code</b>	<b>Catalogue Section</b>	<b>Qty Pg</b>
HPLED1B	LED OUTDOOR	1 222
HPLED1W	LED OUTDOOR	1 222
HS20MM	TOOLS & TEST EQUIPMENT	1 102
HS25MM	TOOLS & TEST EQUIPMENT	1 102
HS32MM	TOOLS & TEST EQUIPMENT	1 102
HS38MM	TOOLS & TEST EQUIPMENT	1 102
HS51MM	TOOLS & TEST EQUIPMENT	1 102
HS60MM	TOOLS & TEST EQUIPMENT	1 102
HS65MM	TOOLS & TEST EQUIPMENT	1 102
HS70MM	TOOLS & TEST EQUIPMENT	1 102
HS72MM	TOOLS & TEST EQUIPMENT	1 102
HS75MM	TOOLS & TEST EQUIPMENT	1 102
HS80MM	TOOLS & TEST EQUIPMENT	1 102
HS85MM	TOOLS & TEST EQUIPMENT	1 102
HS90MM	TOOLS & TEST EQUIPMENT	1 102
HSARBORL	TOOLS & TEST EQUIPMENT	1 102
HSARBORS	TOOLS & TEST EQUIPMENT	1 102
HSPILOTDB5	TOOLS & TEST EQUIPMENT	1 102

**I**

<b>Code</b>	<b>Catalogue Section</b>	<b>Qty Pg</b>
IN001	INDUSTRIAL	10 99
IN0010	INDUSTRIAL	5 100
IN0011	INDUSTRIAL	10 100
IN0012	INDUSTRIAL	10 100
IN0013	INDUSTRIAL	10 100
IN0014	INDUSTRIAL	10 100
IN0015	INDUSTRIAL	10 100
IN0016	INDUSTRIAL	10 100
IN0017	INDUSTRIAL	10 100
IN0018	INDUSTRIAL	10 100
IN0019	INDUSTRIAL	10 100
IN002	INDUSTRIAL	10 99
IN0020	INDUSTRIAL	10 100
IN0021	INDUSTRIAL	1 100
IN0022	INDUSTRIAL	1 100
IN0025	INDUSTRIAL	1 99
IN0026	INDUSTRIAL	1 99
IN0027	INDUSTRIAL	1 99
IN003	INDUSTRIAL	10 99
IN004	INDUSTRIAL	10 99
IN005	INDUSTRIAL	5 99
IN006	INDUSTRIAL	10 100
IN007	INDUSTRIAL	10 100
IN008	INDUSTRIAL	10 100
IN009	INDUSTRIAL	20 100
IP2000	WEATHERPROOF	1 90
IP3000	WEATHERPROOF	1 90
IP3G	WEATHERPROOF	1 91
IP5G	WEATHERPROOF	1 91
IP6000	WEATHERPROOF	1 92
IP6300	WEATHERPROOF	1 92
IP663G	WEATHERPROOF	1 91
IP665G	WEATHERPROOF	1 91

## A-Z INDEX

Code	Catalogue Section	Qty	Pg
IP68JBS	TRANSFORMERS/DRIVERS	1	246
IP7000	WEATHERPROOF	1	90
IP7000D	WEATHERPROOF	1	90
IP7000R	WEATHERPROOF	1	90
IP9000	WEATHERPROOF	1	90
IP9000R	WEATHERPROOF	1	90
IPRCD	WEATHERPROOF	1	90

## J

Code	Catalogue Section	Qty	Pg
JB001	WEATHERPROOF	1	85
JB0010	WEATHERPROOF	1	92
JB002	WEATHERPROOF	1	92
JB003	WEATHERPROOF	1	92
JB004	WEATHERPROOF	1	92
JB005	WEATHERPROOF	1	92
JB006	WEATHERPROOF	10	92
JB007	WEATHERPROOF	1	92
JB008	WEATHERPROOF	1	92
JB009	WEATHERPROOF	1	92

## K

Code	Catalogue Section	Qty	Pg
KIT15BCW	LIGHTING KITS	1	221
KIT16B	LIGHTING KITS	1	220
KIT16W	LIGHTING KITS	1	220
KIT2B	LIGHTING KITS	1	221
KIT2W	LIGHTING KITS	1	221
KIT3B	LIGHTING KITS	1	221
KIT3W	LIGHTING KITS	1	221
KIT4B	LIGHTING KITS	1	221
KIT4W	LIGHTING KITS	1	221
KIT5M	LIGHTING KITS	1	221
KIT5X	LIGHTING KITS	1	221

## L

Code	Catalogue Section	Qty	Pg
L01C	LIGHTING PRODUCTS	1	133
L01CBR	LIGHTING PRODUCTS	1	133
L01W	LIGHTING PRODUCTS	1	133
L02B1	LIGHTING PRODUCTS	1	133
L02BK1	LIGHTING PRODUCTS	1	133
L02C1	LIGHTING PRODUCTS	1	133
L02CBR1	LIGHTING PRODUCTS	1	133
L02W1	LIGHTING PRODUCTS	1	133
L1000	LAMPS	50	241
L110	LAMPS	50	241
L120	LAMPS	50	241
L160	LAMPS	50	241
L22D	LAMPS	20	242
L230	LAMPS	50	241
L25D	LAMPS	20	242
L400	LAMPS	50	241
L50D	LAMPS	20	242
L58D	LAMPS	20	242

Code	Catalogue Section	Qty	Pg
L69D	LAMPS	20	242
L58DAL	LAMPS	20	242
L58DB	LAMPS	20	242
L58DL	LAMPS	20	242
L58DR	LAMPS	20	242
L59D	LAMPS	20	242
L59DAL	LAMPS	20	242
L69D	LAMPS	20	242
L69DAL	LAMPS	20	242
L80	LAMPS	50	241
L81D	LAMPS	20	242
L81DAL	LAMPS	20	242
LC1	LIGHTING PRODUCTS	1	142
LC2	LIGHTING PRODUCTS	1	142
LC3	LIGHTING PRODUCTS	1	142
LC4	LIGHTING PRODUCTS	1	142
LC5	LIGHTING PRODUCTS	1	142
LC6	LIGHTING PRODUCTS	1	142
LE04B1	LIGHTING PRODUCTS	1	134
LE04BK1	LIGHTING PRODUCTS	1	134
LE04C1	LIGHTING PRODUCTS	1	134
LE04CBR1	LIGHTING PRODUCTS	1	134
LE04W1	LIGHTING PRODUCTS	1	134
LED100	LED STRIPS & FLEX	1	146
LED1000	LED STRIPS & FLEX	1	146
LED11WB	LED STRIPS & FLEX	1	145
LED11WCW	LED STRIPS & FLEX	1	145
LED11WWW	LED STRIPS & FLEX	1	145
LED144K	LED LAMPS	1	241
LED146K	LED LAMPS	1	241
LED24RGB	LED STRIPS & FLEX	1	147
LED250	LED STRIPS & FLEX	1	146
LED2500	LED STRIPS & FLEX	1	146
LED3WB	LED STRIPS & FLEX	1	145
LED3WCW	LED STRIPS & FLEX	1	145
LED3WWW	LED STRIPS & FLEX	1	145
LED5WB	LED STRIPS & FLEX	1	145
LED5WCW	LED STRIPS & FLEX	1	145
LED5WWW	LED STRIPS & FLEX	1	145
LED8SPLIT	LED STRIPS & FLEX	1	146
LEDADP36	LED STRIPS & FLEX	1	146
LEDBAT10	LED LIGHTING	1	152
LEDBAT20	LED LIGHTING	1	152
LEDBAT25	LED LIGHTING	1	152
LEDDIMMER	LED STRIPS & FLEX	1	146
LEDF12B	LED STRIPS & FLEX	1	148
LEDF12CW	LED STRIPS & FLEX	1	148
LEDF12G	LED STRIPS & FLEX	1	148
LEDF12IPB	LED STRIPS & FLEX	1	148
LEDF12IPCW	LED STRIPS & FLEX	1	148
LEDF12IPWW	LED STRIPS & FLEX	1	148
LEDF12R	LED STRIPS & FLEX	1	148
LEDF12WW	LED STRIPS & FLEX	1	148
LEDF12Y	LED STRIPS & FLEX	1	148

Code	Catalogue Section	Qty	Pg
LEDF212B	LED STRIPS & FLEX	1	148
LEDF212CW	LED STRIPS & FLEX	1	148
LEDF212WW	LED STRIPS & FLEX	1	148
LEDF24B	LED STRIPS & FLEX	1	148
LEDF24CW	LED STRIPS & FLEX	1	148
LEDF24WW	LED STRIPS & FLEX	1	148
LEDCLIP	LED STRIPS & FLEX	1	146
LEDCON	LED STRIPS & FLEX	1	146
LEDGL5	LED OUTDOOR	1	218
LEDGL6	LED OUTDOOR	1	218
LEDGL9	LED OUTDOOR	1	218
LEDM06B	LED OUTDOOR	1	220
LEDM06W	LED OUTDOOR	1	220
LEDM07B	LED OUTDOOR	1	219
LEDM07W	LED OUTDOOR	1	219
LEDM08B1	LED OUTDOOR	1	219
LEDM08W1	LED OUTDOOR	1	219
LEDMRC	LED LIGHTING	1	173
LEDPAN2	LED LIGHTING	1	173
LEDPAN3	LED LIGHTING	1	173
LEDRACON	LED STRIPS & FLEX	1	146
LEDREC	LED LIGHTING	1	143
LEDT11WCW	LED STRIPS & FLEX	1	145
LEDT11WWW	LED STRIPS & FLEX	1	145
LEDT3WCW	LED STRIPS & FLEX	1	145
LEDT3WWW	LED STRIPS & FLEX	1	145
LEDT5WCW	LED STRIPS & FLEX	1	145
LEDT5WWW	LED STRIPS & FLEX	1	145
LEDTCLIP	LED STRIPS & FLEX	1	145
LEDTCON	LED STRIPS & FLEX	1	145
LEDTD1	LED STRIPS & FLEX	1	146
LEDTD2	LED STRIPS & FLEX	1	146
LEDTRI	LED LIGHTING	1	143
LG06C	LIGHTING PRODUCTS	1	133
LG06CBR	LIGHTING PRODUCTS	1	133
LG06W	LIGHTING PRODUCTS	1	133
LH01	MISCELLANEOUS ACCESSORIES	50	248
LH01C	MISCELLANEOUS ACCESSORIES	50	248
LH02	MISCELLANEOUS ACCESSORIES	50	248
LH03	MISCELLANEOUS ACCESSORIES	50	248
LH04	MISCELLANEOUS ACCESSORIES	50	248
LIN1	LED LIGHTING	1	180
LIN2	LED LIGHTING	1	180
LIN200	LED LIGHTING	1	180
LIN3	LED LIGHTING	1	180
LIN300	LED LIGHTING	1	180
LIN4	LED LIGHTING	1	180
LIN450	LED LIGHTING	1	180
LINCUP	LED LIGHTING	5	180
LINP	LED LIGHTING	1	180
LINS	LED LIGHTING	1	180
LJ001	TELEPHONE ACCESSORIES	1	78
LJ0010	TELEPHONE ACCESSORIES	1	78
LJ0011	TELEPHONE ACCESSORIES	1	78

Code	Catalogue Section	Qty	Pg
LJ0012	TELEPHONE ACCESSORIES	1	78
LJ0013	TELEPHONE ACCESSORIES	1	78
LJ005	TELEPHONE ACCESSORIES	10	78
LJ006	TELEPHONE ACCESSORIES	10	78
LJ007	TELEPHONE ACCESSORIES	10	78
LJ008	TELEPHONE ACCESSORIES	10	78
LJ009	TELEPHONE ACCESSORIES	10	78
LJ5002	DATAComms ACCESSORIES	1	75
LJ5207BP	DATAComms ACCESSORIES	1	75
LSC1	MISCELLANEOUS ACCESSORIES	10	248
LT101C	LIGHTING PRODUCTS	1	143
LT101CBR	LIGHTING PRODUCTS	1	143
LT101W	LIGHTING PRODUCTS	1	143
LVC1	MISCELLANEOUS ACCESSORIES	100	248
LVC2	MISCELLANEOUS ACCESSORIES	100	248
LVL1	LAMPS	20	240
LVL2	LAMPS	20	240
LVL3	LAMPS	20	240

## M

Code	Catalogue Section	Qty	Pg
M1100	METAL CLAD	1	96
M1200	METAL CLAD	1	96
M1G	METAL CLAD	1	98
M2000	METAL CLAD	10	96
M2161	METAL CLAD	1	96
M2162	METAL CLAD	1	96
M2G	METAL CLAD	1	98
M3000	METAL CLAD	10	96
M4000	METAL CLAD	10	96
M4100	METAL CLAD	1	96
M4200	METAL CLAD	1	96
M4G	METAL CLAD	1	98
M6000	METAL CLAD	10	97
M6000N	METAL CLAD	10	97
M6300	METAL CLAD	10	97
M6300F	METAL CLAD	10	97
M6300N	METAL CLAD	10	97
M7000	METAL CLAD	10	95
M7000U	METAL CLAD	10	95
M7300	METAL CLAD	1	98
M7400	METAL CLAD	1	98
M8331N	METAL CLAD	1	97
M8332N	METAL CLAD	1	97
M8333N	METAL CLAD	1	97
M8341	METAL CLAD	10	97
M8341N	METAL CLAD	10	97
M8341WH	METAL CLAD	1	97
M8500	METAL CLAD	10	98
M8600	METAL CLAD	10	98
M8700	METAL CLAD	10	98
M8900	METAL CLAD	5	98
M9000	METAL CLAD	5	95
M9000U	METAL CLAD	5	95

## A-Z INDEX

Code	Catalogue Section	Qty	Pg
MD03B	LIGHTING PRODUCTS	1	137
MC7000USB	METAL CLAD	1	95
MC9000USB	METAL CLAD	1	95
MD01C	LIGHTING PRODUCTS	1	137
MD01W	LIGHTING PRODUCTS	1	137
MD02B	LIGHTING PRODUCTS	1	137
MD02C	LIGHTING PRODUCTS	1	137
MD02W	LIGHTING PRODUCTS	1	137
MD03B	LIGHTING PRODUCTS	1	137
MD03C	LIGHTING PRODUCTS	1	137
MD03W	LIGHTING PRODUCTS	1	137
ME04B	LIGHTING PRODUCTS	1	137
ME04C	LIGHTING PRODUCTS	1	137
ME04W	LIGHTING PRODUCTS	1	137
ME05B	LIGHTING PRODUCTS	1	137
ME05C	LIGHTING PRODUCTS	1	137
ME05W	LIGHTING PRODUCTS	1	137
ME06B	LIGHTING PRODUCTS	1	137
ME06C	LIGHTING PRODUCTS	1	137
ME06W	LIGHTING PRODUCTS	1	137
MIXEDFUSES	WIRING ACCESSORIES	100	249
MRA436EMHF	HIGH FREQUENCY MODULAR & FLUORESCENT FITTINGS	1	175
MRA436HF	HIGH FREQUENCY MODULAR & FLUORESCENT FITTINGS	1	175
MRB418EMHF	HIGH FREQUENCY MODULAR & FLUORESCENT FITTINGS	1	175
MRB418HF	HIGH FREQUENCY MODULAR & FLUORESCENT FITTINGS	1	175
MRBLED	LED LIGHTING	1	172
MRBLED6	LED LIGHTING	1	172
MRC414EMHF	HIGH FREQUENCY MODULAR & FLUORESCENT FITTINGS	1	174
MRC414HF	HIGH FREQUENCY MODULAR & FLUORESCENT FITTINGS	1	174
MRC0B5CW	LED LAMPS	10	236
MRC0B5WW	LED LAMPS	10	236
MRD255PLEMHF	HIGH FREQUENCY MODULAR & FLUORESCENT FITTINGS	1	176
MRD255PLHF	HIGH FREQUENCY MODULAR & FLUORESCENT FITTINGS	1	176
MRE255PLEMHF	HIGH FREQUENCY MODULAR & FLUORESCENT FITTINGS	1	176
MRE255PLHF	HIGH FREQUENCY MODULAR & FLUORESCENT FITTINGS	1	176
MRF255PLEMHF	HIGH FREQUENCY MODULAR & FLUORESCENT FITTINGS	1	176
MRF255PLHF	HIGH FREQUENCY MODULAR & FLUORESCENT FITTINGS	1	176
MRG414EMHF	HIGH FREQUENCY MODULAR & FLUORESCENT FITTINGS	1	174
MRG414HF	HIGH FREQUENCY MODULAR & FLUORESCENT FITTINGS	1	174
MRH414EMHF	HIGH FREQUENCY MODULAR & FLUORESCENT FITTINGS	1	174
MRH414HF	HIGH FREQUENCY MODULAR & FLUORESCENT FITTINGS	1	174
MRJ45	METAL CLAD	1	98
MSENSOR	LIGHTING PRODUCTS	1	196

## N

Code	Catalogue Section	Qty	Pg
NC65114HF	COMMERCIAL LIGHTING	1	188
NC65128HF	COMMERCIAL LIGHTING	1	188
NC65135EMHF	COMMERCIAL LIGHTING	1	188
NC65135HF	COMMERCIAL LIGHTING	1	188
NC65214HF	COMMERCIAL LIGHTING	1	188
NC65228HF	COMMERCIAL LIGHTING	1	188
NC65235EMHF	COMMERCIAL LIGHTING	1	188
NC65235HF	COMMERCIAL LIGHTING	1	188
NCLD36	LED LIGHTING	1	186
NCLD36EM	LED LIGHTING	1	186
NCLD48	LED LIGHTING	1	186
NCLD48EM	LED LIGHTING	1	186
NCT5CLIP	COMMERCIAL LIGHTING	20	188
NET13BK	DATAKOMMS ACCESSORIES	1	72
NET13WH	DATAKOMMS ACCESSORIES	1	72
NET16WH	DATAKOMMS ACCESSORIES	10	70
NET26WH	DATAKOMMS ACCESSORIES	10	70
NET46WH	DATAKOMMS ACCESSORIES	10	70
NET6KIT1	DATAKOMMS ACCESSORIES	1	73
NET6KIT2	DATAKOMMS ACCESSORIES	1	73
NETBRUSH2G	DATAKOMMS ACCESSORIES	1	73
NETBRUSH4G	DATAKOMMS ACCESSORIES	1	73
NETBTMBK	DATAKOMMS ACCESSORIES	1	70
NETBTMWH	DATAKOMMS ACCESSORIES	1	70
NETBTSBK	DATAKOMMS ACCESSORIES	1	70
NETBTSWH	DATAKOMMS ACCESSORIES	1	70
NETC510M	DATAKOMMS ACCESSORIES	1	74
NETC51M	DATAKOMMS ACCESSORIES	1	74
NETC53M	DATAKOMMS ACCESSORIES	1	74
NETC55M	DATAKOMMS ACCESSORIES	1	74
NETC5CP	DATAKOMMS ACCESSORIES	1	75
NETC610M	DATAKOMMS ACCESSORIES	1	74
NETC61M	DATAKOMMS ACCESSORIES	1	74
NETC63M	DATAKOMMS ACCESSORIES	1	74
NETC65M	DATAKOMMS ACCESSORIES	1	74
NETC6CP	DATAKOMMS ACCESSORIES	1	75
NETCAT5BK	DATAKOMMS ACCESSORIES	1	70
NETCAT5WH	DATAKOMMS ACCESSORIES	1	70
NETCAT6BK	DATAKOMMS ACCESSORIES	1	70
NETCAT6WH	DATAKOMMS ACCESSORIES	1	70
NETDISATBK	DATAKOMMS ACCESSORIES	1	71
NETDISATWH	DATAKOMMS ACCESSORIES	1	71
NETDITYBK	DATAKOMMS ACCESSORIES	1	71
NETDITVWH	DATAKOMMS ACCESSORIES	1	71
NETHBK	DATAKOMMS ACCESSORIES	1	72
NETHDMIBK	DATAKOMMS ACCESSORIES	1	72
NETHDMIWH	DATAKOMMS ACCESSORIES	1	72
NETHWH	DATAKOMMS ACCESSORIES	1	72
NETQBK	DATAKOMMS ACCESSORIES	1	72
NETQDBK	DATAKOMMS ACCESSORIES	1	71
NETQDWH	DATAKOMMS ACCESSORIES	1	71
NETQWH	DATAKOMMS ACCESSORIES	1	72
NETRJ11BK	DATAKOMMS ACCESSORIES	1	70

Code	Catalogue Section	Qty	Pg
NETRJ11WH	DATAACOMMS ACCESSORIES	1	70
NETSATBK	DATAACOMMS ACCESSORIES	1	72
NETSATSBK	DATAACOMMS ACCESSORIES	1	71
NETSATSWH	DATAACOMMS ACCESSORIES	1	71
NETSATWH	DATAACOMMS ACCESSORIES	1	72
NETTRIBK	DATAACOMMS ACCESSORIES	1	71
NETTRIWH	DATAACOMMS ACCESSORIES	1	71
NETTVBK	DATAACOMMS ACCESSORIES	1	72
NETTVSBK	DATAACOMMS ACCESSORIES	1	71
NETTVSWH	DATAACOMMS ACCESSORIES	1	71
NETVWH	DATAACOMMS ACCESSORIES	1	72
NETUSBBK	DATAACOMMS ACCESSORIES	1	72
NETUSBWH	DATAACOMMS ACCESSORIES	1	72
NH0112DS	LIGHTING PRODUCTS	1	227
NH016W	LED OUTDOOR	1	224
NH017W	LED OUTDOOR	1	224
NH0183BD	LIGHTING PRODUCTS	1	160
NH0184SQ	LIGHTING PRODUCTS	1	160
NH019B	LED OUTDOOR	1	224
NH019W	LED OUTDOOR	1	224
NH020B	LED OUTDOOR	1	224
NH020W	LED OUTDOOR	1	224
NH021W	LIGHTING PRODUCTS	1	225
NH022W	LIGHTING PRODUCTS	1	225
NH023B	LED OUTDOOR	1	159
NH023W	LED OUTDOOR	1	159
NH025W	LED OUTDOOR	1	159
NH027	OUTDOOR LIGHTING	1	226
NH027S	OUTDOOR LIGHTING	1	226
NH028	OUTDOOR LIGHTING	1	226
NH028S	OUTDOOR LIGHTING	1	226
NH1061W	LED OUTDOOR	1	225
NH1064W	LED OUTDOOR	1	225
NL001	MISCELLANEOUS ACCESSORIES	1	249
NL002	MISCELLANEOUS ACCESSORIES	1	249

**O**

Code	Catalogue Section	Qty	Pg
OS001	SENSORS	1	117
OS0011	SENSORS	1	116
OS001B	SENSORS	1	117
OS002	SENSORS	1	115
OS003	SENSORS	1	115
OS004	SENSORS	1	117
OS004B	SENSORS	1	117
OS005	SENSORS	1	118
OS006	SENSORS	1	118
OS007	SENSORS	1	116
OS009	SENSORS	1	115
OVFL02	FLOODLIGHTS & SECURITY LIGHTING	1	205
OVFL08	FLOODLIGHTS & SECURITY LIGHTING	1	205

**P**

Code	Catalogue Section	Qty	Pg
P1163	LIGHTING PRODUCTS	1	215
P1200M	PURE WHITE RANGE	1	9
PAR38120W	LAMPS	1	243
PAR3880B	LAMPS	1	243
PAR3880G	LAMPS	1	243
PAR3880R	LAMPS	1	243
PAR3880W	LAMPS	1	243
PAR3880Y	LAMPS	1	243
PIR0901	SENSORS	1	116
PIR0901S	SENSORS	1	116
PL18W2P	LAMP	1	241
PL18LED	LED DOWNLIGHTS	1	170
PL18W4P	LAMPS	20	241
PL23LED	LED DOWNLIGHTS	1	170
PL26W4P	LAMPS	20	241
PL55W4P	LAMPS	10	241
PL9W2P	LAMPS	10	241
PLBL01	LIGHTING PRODUCTS	1	223
PLD118	COMMERCIAL LIGHTING	1	171
PLD126	COMMERCIAL LIGHTING	1	171
PLD218	COMMERCIAL LIGHTING	1	171
PLD218EM	COMMERCIAL LIGHTING	1	171
PLD226	COMMERCIAL LIGHTING	1	171
PLD226EM	COMMERCIAL LIGHTING	1	171
PLD23W	TRANSFORMERS/DRIVERS	1	170
PLDDGM	COMMERCIAL LIGHTING	1	171
PLDIPCG	COMMERCIAL LIGHTING	1	171
PLDIPMG	COMMERCIAL LIGHTING	1	171
PLED5W	LED DOWNLIGHTS	1	170
PLED9W	LED DOWNLIGHTS	1	170
PPC24	DATAACOMMS ACCESSORIES	1	74
PPC24CAT6	DATAACOMMS ACCESSORIES	1	74
PPC48	DATAACOMMS ACCESSORIES	1	74
PPC48CAT6	DATAACOMMS ACCESSORIES	1	74
PRS235EMHF	HIGH FREQUENCY MODULAR & FLUORESCENT FITTINGS	1	180
PRS235HF	HIGH FREQUENCY MODULAR & FLUORESCENT FITTINGS	1	180
PS0100	PURE WHITE RANGE	1	15
PS0130	PURE WHITE RANGE	1	15
PS0140	PURE WHITE RANGE	1	15
PS1200	PURE WHITE RANGE	1	15
PS2000	PURE WHITE RANGE	1	15
PS2161	PURE WHITE RANGE	1	15
PS2162	PURE WHITE RANGE	1	15
PS2163	PURE WHITE RANGE	1	15
PS2164	PURE WHITE RANGE	1	15
PS3000	PURE WHITE RANGE	1	15
PS4000	PURE WHITE RANGE	1	15
PS4100	PURE WHITE RANGE	1	15
PS4200	PURE WHITE RANGE	1	15
PS7000	PURE WHITE RANGE	1	14
PS7000N	PURE WHITE RANGE	1	14

## A-Z INDEX

Code	Catalogue Section	Qty	Pg
PS7000U	PURE WHITE RANGE	1	14
PS7300	PURE WHITE RANGE	1	15
PS7400	PURE WHITE RANGE	1	15
PS9000	PURE WHITE RANGE	1	14
PS9000N	PURE WHITE RANGE	1	14
PS9000U	PURE WHITE RANGE	1	14
PU0100	PURE WHITE RANGE	1	13
PU0130	PURE WHITE RANGE	1	13
PU0140	PURE WHITE RANGE	1	13
PU1100	PURE WHITE RANGE	1	9
PU1200	PURE WHITE RANGE	1	9
PU1300	PURE WHITE RANGE	10	16
PU1400	PURE WHITE RANGE	10	16
PU1500	PURE WHITE RANGE	10	16
PU1600	PURE WHITE RANGE	10	16
PU1610	PURE WHITE RANGE	10	16
PU1700	PURE WHITE RANGE	10	16
PU1800	PURE WHITE RANGE	10	16
PU2000	PURE WHITE RANGE	1	9
PU2161	PURE WHITE RANGE	1	10
PU2162	PURE WHITE RANGE	1	10
PU2163	PURE WHITE RANGE	1	10
PU2164	PURE WHITE RANGE	1	10
PU2U	PURE WHITE RANGE	1	8
PU3000	PURE WHITE RANGE	1	9
PU4000	PURE WHITE RANGE	1	9
PU4100	PURE WHITE RANGE	1	9
PU4200	PURE WHITE RANGE	1	9
PU5U	PURE WHITE RANGE	1	8
PU6000	PURE WHITE RANGE	1	11
PU6000F	PURE WHITE RANGE	1	11
PU6000N	PURE WHITE RANGE	1	11
PU6300	PURE WHITE RANGE	1	11
PU6300F	PURE WHITE RANGE	1	11
PU6300N	PURE WHITE RANGE	1	11
PU7000	PURE WHITE RANGE	1	8
PU7000N	PURE WHITE RANGE	1	8
PU7000U	PURE WHITE RANGE	1	8
PU7300	PURE WHITE RANGE	1	13
PU7400	PURE WHITE RANGE	1	13
PU8331	PURE WHITE RANGE	1	12
PU8331N	PURE WHITE RANGE	1	12
PU8332	PURE WHITE RANGE	1	12
PU8332N	PURE WHITE RANGE	1	12
PU8333	PURE WHITE RANGE	1	12
PU8333N	PURE WHITE RANGE	1	12
PU8340	PURE WHITE RANGE	1	12
PU8341	PURE WHITE RANGE	1	9
PU8341F	PURE WHITE RANGE	1	9
PU8341N	PURE WHITE RANGE	1	9
PU8342	PURE WHITE RANGE	1	11
PU8350	PURE WHITE RANGE	10	13
PU8360	PURE WHITE RANGE	5	13
PU8900	PURE WHITE RANGE	2	8

Code	Catalogue Section	Qty	Pg
PU9000	PURE WHITE RANGE	1	8
PU9000N	PURE WHITE RANGE	1	8
PU9000U	PURE WHITE RANGE	1	8
PU9901	PURE WHITE RANGE	1	7
PU9902	PURE WHITE RANGE	1	7
PU9SPACER	PURE WHITE RANGE	1	7

## R

Code	Catalogue Section	Qty	Pg
RCD001	RCD PRODUCTS	1	89
RCD002	RCD PRODUCTS	1	89
RCD6000	RCD PRODUCTS	1	67
RCD9000	RCD PRODUCTS	1	63
RCT5039	BATHROOM	1	164
RCT5048	BATHROOM	1	164
RCT6045	BATHROOM	1	166
RCT6045SD	BATHROOM	1	166
RCT6070S	BATHROOM	1	166
RCT6070SD	BATHROOM	1	166
RCTM2LED	BATHROOM	1	163
RCTM2T8	BATHROOM	1	165
RD1B	LIGHTING PRODUCTS	1	132
RD1C	LIGHTING PRODUCTS	1	132
RD1CBR	LIGHTING PRODUCTS	1	132
RD1W	LIGHTING PRODUCTS	1	132
RD2B	LIGHTING PRODUCTS	1	132
RD2C	LIGHTING PRODUCTS	1	132
RD2CBR	LIGHTING PRODUCTS	1	132
RD2W	LIGHTING PRODUCTS	1	132
RDSHC	LIGHTING PRODUCTS	1	168
RDSHCBR	LIGHTING PRODUCTS	1	168
RDSHW	LIGHTING PRODUCTS	1	168
RGBAMP	LED STRIPS & FLEX	1	149
RGBCON	LED STRIPS & FLEX	1	147
RGBFCON	LED STRIPS & FLEX	1	149
RGBFLEX	LED STRIPS & FLEX	1	149

## S

Code	Catalogue Section	Qty	Pg
SC15A	WIRING ACCESSORIES	10	249
SC30A	WIRING ACCESSORIES	10	249
SC3A	WIRING ACCESSORIES	10	249
SC5A	WIRING ACCESSORIES	10	249
SC60A	WIRING ACCESSORIES	10	249
SF0100BC	SCREWLESS FLAT PLATE RANGE	1	33
SF0100BN	SCREWLESS FLAT PLATE RANGE	1	33
SF0100MB	SCREWLESS FLAT PLATE RANGE	1	33
SF0100PB	SCREWLESS FLAT PLATE RANGE	1	33
SF0100PC	SCREWLESS FLAT PLATE RANGE	1	33
SF0140BC	SCREWLESS FLAT PLATE RANGE	1	33
SF0140BN	SCREWLESS FLAT PLATE RANGE	1	33
SF0140MB	SCREWLESS FLAT PLATE RANGE	1	33
SF0140PB	SCREWLESS FLAT PLATE RANGE	1	33
SF0140PC	SCREWLESS FLAT PLATE RANGE	1	33



# A-Z INDEX

Code	Catalogue Section	Qty	Pg
SF5ABNW	SCREWLESS FLAT PLATE RANGE	1	24
SF5AMB	SCREWLESS FLAT PLATE RANGE	1	24
SF5APB	SCREWLESS FLAT PLATE RANGE	1	24
SF5APBW	SCREWLESS FLAT PLATE RANGE	1	24
SF5APC	SCREWLESS FLAT PLATE RANGE	1	24
SF5APCW	SCREWLESS FLAT PLATE RANGE	1	24
SF6000BC	SCREWLESS FLAT PLATE RANGE	1	30
SF6000BN	SCREWLESS FLAT PLATE RANGE	1	30
SF6000MB	SCREWLESS FLAT PLATE RANGE	1	30
SF6000NBC	SCREWLESS FLAT PLATE RANGE	1	30
SF6000NBN	SCREWLESS FLAT PLATE RANGE	1	30
SF6000NMB	SCREWLESS FLAT PLATE RANGE	1	30
SF6000NPB	SCREWLESS FLAT PLATE RANGE	1	30
SF6000NPC	SCREWLESS FLAT PLATE RANGE	1	30
SF6000PC	SCREWLESS FLAT PLATE RANGE	1	30
SF6000PC	SCREWLESS FLAT PLATE RANGE	1	30
SF6300BC	SCREWLESS FLAT PLATE RANGE	1	30
SF6300BN	SCREWLESS FLAT PLATE RANGE	1	30
SF6300MB	SCREWLESS FLAT PLATE RANGE	1	30
SF6300NBC	SCREWLESS FLAT PLATE RANGE	1	30
SF6300NBN	SCREWLESS FLAT PLATE RANGE	1	30
SF6300NMB	SCREWLESS FLAT PLATE RANGE	1	30
SF6300NPB	SCREWLESS FLAT PLATE RANGE	1	30
SF6300NPC	SCREWLESS FLAT PLATE RANGE	1	30
SF6300PB	SCREWLESS FLAT PLATE RANGE	1	30
SF6300PC	SCREWLESS FLAT PLATE RANGE	1	30
SF7000BC	SCREWLESS FLAT PLATE RANGE	1	21
SF7000BCW	SCREWLESS FLAT PLATE RANGE	1	21
SF7000BN	SCREWLESS FLAT PLATE RANGE	1	21
SF7000BNW	SCREWLESS FLAT PLATE RANGE	1	21
SF7000MB	SCREWLESS FLAT PLATE RANGE	1	21
SF7000PB	SCREWLESS FLAT PLATE RANGE	1	21
SF7000PBW	SCREWLESS FLAT PLATE RANGE	1	21
SF7000PC	SCREWLESS FLAT PLATE RANGE	1	21
SF7000PCW	SCREWLESS FLAT PLATE RANGE	1	21
SF7300BC	SCREWLESS FLAT PLATE RANGE	1	33
SF7300BN	SCREWLESS FLAT PLATE RANGE	1	33
SF7300MB	SCREWLESS FLAT PLATE RANGE	1	33
SF7300PB	SCREWLESS FLAT PLATE RANGE	1	33
SF7300PC	SCREWLESS FLAT PLATE RANGE	1	33
SF7400BC	SCREWLESS FLAT PLATE RANGE	1	33
SF7400BN	SCREWLESS FLAT PLATE RANGE	1	33
SF7400MB	SCREWLESS FLAT PLATE RANGE	1	33
SF7400PB	SCREWLESS FLAT PLATE RANGE	1	33
SF7400PC	SCREWLESS FLAT PLATE RANGE	1	33
SF7USB4BC	SCREWLESS FLAT PLATE RANGE	1	23
SF7USB4BCW	SCREWLESS FLAT PLATE RANGE	1	23
SF7USB4BN	SCREWLESS FLAT PLATE RANGE	1	23
SF7USB4BNW	SCREWLESS FLAT PLATE RANGE	1	23
SF7USB4MB	SCREWLESS FLAT PLATE RANGE	1	23
SF7USB4PB	SCREWLESS FLAT PLATE RANGE	1	23
SF7USB4PBW	SCREWLESS FLAT PLATE RANGE	1	23
SF7USB4PC	SCREWLESS FLAT PLATE RANGE	1	23
SF7USB4PCW	SCREWLESS FLAT PLATE RANGE	1	23
SF8331NBC	SCREWLESS FLAT PLATE RANGE	1	32

Code	Catalogue Section	Qty	Pg
SF8331NBN	SCREWLESS FLAT PLATE RANGE	1	32
SF8331NMB	SCREWLESS FLAT PLATE RANGE	1	32
SF8331NPB	SCREWLESS FLAT PLATE RANGE	1	32
SF8331NPC	SCREWLESS FLAT PLATE RANGE	1	32
SF8332NBC	SCREWLESS FLAT PLATE RANGE	1	32
SF8332NBN	SCREWLESS FLAT PLATE RANGE	1	32
SF8332NMB	SCREWLESS FLAT PLATE RANGE	1	32
SF8332NPB	SCREWLESS FLAT PLATE RANGE	1	32
SF8332NPC	SCREWLESS FLAT PLATE RANGE	1	32
SF8333NBC	SCREWLESS FLAT PLATE RANGE	1	32
SF8333NBCW	SCREWLESS FLAT PLATE RANGE	1	32
SF8333NBN	SCREWLESS FLAT PLATE RANGE	1	32
SF8333NBNW	SCREWLESS FLAT PLATE RANGE	1	32
SF8333NMB	SCREWLESS FLAT PLATE RANGE	1	32
SF8333NPB	SCREWLESS FLAT PLATE RANGE	1	32
SF8333NPBW	SCREWLESS FLAT PLATE RANGE	1	32
SF8333NPC	SCREWLESS FLAT PLATE RANGE	1	32
SF8333NPCW	SCREWLESS FLAT PLATE RANGE	1	32
SF8341BC	SCREWLESS FLAT PLATE RANGE	1	31
SF8341BN	SCREWLESS FLAT PLATE RANGE	1	31
SF8341MB	SCREWLESS FLAT PLATE RANGE	1	31
SF8341NBC	SCREWLESS FLAT PLATE RANGE	1	31
SF8341NBN	SCREWLESS FLAT PLATE RANGE	1	31
SF8341NMB	SCREWLESS FLAT PLATE RANGE	1	31
SF8341NPB	SCREWLESS FLAT PLATE RANGE	1	31
SF8341NPC	SCREWLESS FLAT PLATE RANGE	1	31
SF8341PB	SCREWLESS FLAT PLATE RANGE	1	31
SF8341PC	SCREWLESS FLAT PLATE RANGE	1	31
SF8350BC	SCREWLESS FLAT PLATE RANGE	1	36
SF8350BN	SCREWLESS FLAT PLATE RANGE	1	36
SF8350MB	SCREWLESS FLAT PLATE RANGE	1	36
SF8350PB	SCREWLESS FLAT PLATE RANGE	1	36
SF8350PC	SCREWLESS FLAT PLATE RANGE	1	36
SF8360BC	SCREWLESS FLAT PLATE RANGE	1	36
SF8360BN	SCREWLESS FLAT PLATE RANGE	1	36
SF8360MB	SCREWLESS FLAT PLATE RANGE	1	36
SF8360PB	SCREWLESS FLAT PLATE RANGE	1	36
SF8360PC	SCREWLESS FLAT PLATE RANGE	1	36
SF8900BC	SCREWLESS FLAT PLATE RANGE	1	21
SF8900BCW	SCREWLESS FLAT PLATE RANGE	1	35
SF8900BN	SCREWLESS FLAT PLATE RANGE	1	35
SF8900BNW	SCREWLESS FLAT PLATE RANGE	1	35
SF8900MB	SCREWLESS FLAT PLATE RANGE	1	35
SF8900PB	SCREWLESS FLAT PLATE RANGE	1	35
SF8900PBW	SCREWLESS FLAT PLATE RANGE	1	35
SF8900PC	SCREWLESS FLAT PLATE RANGE	1	35
SF8900PCW	SCREWLESS FLAT PLATE RANGE	1	35
SF9000BC	SCREWLESS FLAT PLATE RANGE	1	35
SF9000BCW	SCREWLESS FLAT PLATE RANGE	1	21
SF9000BN	SCREWLESS FLAT PLATE RANGE	1	21
SF9000BNW	SCREWLESS FLAT PLATE RANGE	1	21
SF9000MB	SCREWLESS FLAT PLATE RANGE	1	21
SF9000PB	SCREWLESS FLAT PLATE RANGE	1	21
SF9000PBW	SCREWLESS FLAT PLATE RANGE	1	21
SF9000PC	SCREWLESS FLAT PLATE RANGE	1	21



Code	Catalogue Section	Qty	Pg
SF9000PCW	SCREWLESS FLAT PLATE RANGE	1	21
SF9901BC	SCREWLESS FLAT PLATE RANGE	1	22
SF9901BCW	SCREWLESS FLAT PLATE RANGE	1	22
SF9901BN	SCREWLESS FLAT PLATE RANGE	1	22
SF9901BNW	SCREWLESS FLAT PLATE RANGE	1	22
SF9901MB	SCREWLESS FLAT PLATE RANGE	1	22
SF9901PB	SCREWLESS FLAT PLATE RANGE	1	22
SF9901PBW	SCREWLESS FLAT PLATE RANGE	1	22
SF9901PC	SCREWLESS FLAT PLATE RANGE	1	22
SF9901PCW	SCREWLESS FLAT PLATE RANGE	1	22
SF9902BC	SCREWLESS FLAT PLATE RANGE	1	23
SF9902BCW	SCREWLESS FLAT PLATE RANGE	1	23
SF9902BN	SCREWLESS FLAT PLATE RANGE	1	23
SF9902BNW	SCREWLESS FLAT PLATE RANGE	1	23
SF9902MB	SCREWLESS FLAT PLATE RANGE	1	23
SF9902PB	SCREWLESS FLAT PLATE RANGE	1	23
SF9902PBW	SCREWLESS FLAT PLATE RANGE	1	23
SF9902PC	SCREWLESS FLAT PLATE RANGE	1	23
SF9902PCW	SCREWLESS FLAT PLATE RANGE	1	23
SFQUADBC	SCREWLESS FLAT PLATE RANGE	1	22
SFQUADBCW	SCREWLESS FLAT PLATE RANGE	1	22
SFQUADBN	SCREWLESS FLAT PLATE RANGE	1	22
SFQUADBNW	SCREWLESS FLAT PLATE RANGE	1	22
SFQUADMB	SCREWLESS FLAT PLATE RANGE	1	22
SFQUADPB	SCREWLESS FLAT PLATE RANGE	1	22
SFQUADPBW	SCREWLESS FLAT PLATE RANGE	1	22
SFQUADPC	SCREWLESS FLAT PLATE RANGE	1	22
SFQUADPCW	SCREWLESS FLAT PLATE RANGE	1	22
SFRJ45BC	SCREWLESS FLAT PLATE RANGE	1	33
SFRJ45BN	SCREWLESS FLAT PLATE RANGE	1	33
SFRJ45MB	SCREWLESS FLAT PLATE RANGE	1	33
SFRJ45PB	SCREWLESS FLAT PLATE RANGE	1	33
SFRJ45PC	SCREWLESS FLAT PLATE RANGE	1	33
SG116	STEEL GALVANISED BOXES	10	82
SG125	STEEL GALVANISED BOXES	10	82
SG127	STEEL GALVANISED BOXES	20	82
SG135	STEEL GALVANISED BOXES	10	82
SG147	STEEL GALVANISED BOXES	10	82
SG225	STEEL GALVANISED BOXES	10	82
SG235	STEEL GALVANISED BOXES	10	82
SG235D	STEEL GALVANISED BOXES	10	82
SG247	STEEL GALVANISED BOXES	10	82
SG335	STEEL GALVANISED BOXES	10	82
SG335D	STEEL GALVANISED BOXES	10	82
SGZ10B	LIGHTING PRODUCTS	20	136
SGZ10C	LIGHTING PRODUCTS	20	136
SGZ10CBR	LIGHTING PRODUCTS	20	136
SGZ10W	LIGHTING PRODUCTS	20	136
SK001	TRAILING/EXTENSION SOCKETS	1	59
SK002	TRAILING/EXTENSION SOCKETS	1	59
SK003	TRAILING/EXTENSION SOCKETS	1	59
SK004	TRAILING/EXTENSION SOCKETS	1	58
SK005	TRAILING/EXTENSION SOCKETS	1	58
SK006	TRAILING/EXTENSION SOCKETS	1	58

Code	Catalogue Section	Qty	Pg
SK007	TRAILING/EXTENSION SOCKETS	1	59
SLIGHT	BATHROOM	1	164
SM314	DATAComms ACCESSORIES	1	75
SM315	DATAComms ACCESSORIES	1	75
SP1C	LIGHTING PRODUCTS	1	157
SP3C	LIGHTING PRODUCTS	1	157
SP4C	LIGHTING PRODUCTS	1	157
SPGU1BC	LIGHTING PRODUCTS	1	156
SPGU2BC	LIGHTING PRODUCTS	1	156
SPGU3BC	LIGHTING PRODUCTS	1	156
SPGU4BC	LIGHTING PRODUCTS	1	156
SPIKE4BK	LED OUTDOOR	1	213
SPIKE50BL	LED OUTDOOR	1	214
SPIKE5AL	LED OUTDOOR	1	213
SPIKE5SS	LED OUTDOOR	1	213
SPIKEB	OUTDOOR LIGHTING	1	212
SPIKEG	OUTDOOR LIGHTING	1	212
SPIKEW	OUTDOOR LIGHTING	1	212
SPIKEXT	MISCELLANEOUS ACCESSORIES	1	248
SPLD2	SUSPENDED LIGHT FITTINGS	1	181
SPT52	SUSPENDED LIGHT FITTINGS	1	181
ST0100	STANDARD WHITE ACCESSORIES	10	68
ST0110	STANDARD WHITE ACCESSORIES	10	68
ST0120	STANDARD WHITE ACCESSORIES	10	68
ST0140	STANDARD WHITE ACCESSORIES	10	68
ST1000	STANDARD WHITE ACCESSORIES	10	64
ST1100	STANDARD WHITE ACCESSORIES	10	64
ST1200	STANDARD WHITE ACCESSORIES	10	64
ST1200M	STANDARD WHITE ACCESSORIES	1	64
ST1300	STANDARD WHITE ACCESSORIES	10	80
ST1400	STANDARD WHITE ACCESSORIES	10	80
ST1500	STANDARD WHITE ACCESSORIES	10	80
ST1510	STANDARD WHITE ACCESSORIES	10	80
ST1600	STANDARD WHITE ACCESSORIES	10	80
ST1610	STANDARD WHITE ACCESSORIES	10	80
ST1700	STANDARD WHITE ACCESSORIES	10	80
ST1800	STANDARD WHITE ACCESSORIES	10	80
ST1DIM	STANDARD WHITE ACCESSORIES	10	65
ST2000	STANDARD WHITE ACCESSORIES	10	64
ST2161	STANDARD WHITE ACCESSORIES	1	65
ST2162	STANDARD WHITE ACCESSORIES	1	65
ST2163	STANDARD WHITE ACCESSORIES	1	65
ST2164	STANDARD WHITE ACCESSORIES	1	65
ST2165	STANDARD WHITE ACCESSORIES	1	65
ST2DIM	STANDARD WHITE ACCESSORIES	10	65
ST3000	STANDARD WHITE ACCESSORIES	10	64
ST4000	STANDARD WHITE ACCESSORIES	10	64
ST400M	STANDARD WHITE ACCESSORIES	1	65
ST4100	STANDARD WHITE ACCESSORIES	10	64
ST4200	STANDARD WHITE ACCESSORIES	10	64
ST5U	STANDARD WHITE ACCESSORIES	10	63
ST6000	STANDARD WHITE ACCESSORIES	10	67
ST6000-3A	STANDARD WHITE ACCESSORIES	10	67
ST6000N	STANDARD WHITE ACCESSORIES	10	67

## A-Z INDEX

Code	Catalogue Section	Qty	Pg
ST6300	STANDARD WHITE ACCESSORIES	10	67
ST6300N	STANDARD WHITE ACCESSORIES	10	67
ST7000	STANDARD WHITE ACCESSORIES	10	63
ST7000U	STANDARD WHITE ACCESSORIES	10	63
ST7USB4	STANDARD WHITE ACCESSORIES	1	62
ST8310N	STANDARD WHITE ACCESSORIES	10	83
ST8331	STANDARD WHITE ACCESSORIES	10	66
ST8331N	STANDARD WHITE ACCESSORIES	10	66
ST8332	STANDARD WHITE ACCESSORIES	10	66
ST8332N	STANDARD WHITE ACCESSORIES	10	66
ST8333	STANDARD WHITE ACCESSORIES	10	66
ST8333N	STANDARD WHITE ACCESSORIES	10	66
ST8340	STANDARD WHITE ACCESSORIES	10	66
ST8341	STANDARD WHITE ACCESSORIES	10	64
ST8341N	STANDARD WHITE ACCESSORIES	10	64
ST8342	STANDARD WHITE ACCESSORIES	10	64
ST8350	STANDARD WHITE ACCESSORIES	10	68
ST8360	STANDARD WHITE ACCESSORIES	10	68
ST8900	STANDARD WHITE ACCESSORIES	1	63
ST9000U	STANDARD WHITE ACCESSORIES	10	63
ST9001	STANDARD WHITE ACCESSORIES	10	63
ST9002	STANDARD WHITE ACCESSORIES	10	63
ST9903	STANDARD WHITE ACCESSORIES	10	62
ST9904	STANDARD WHITE ACCESSORIES	5	62
ST9SPACER	STANDARD WHITE ACCESSORIES	10	68
STI01C	LIGHTING PRODUCTS	1	144
STI01CBR	LIGHTING PRODUCTS	1	144
STI01W	LIGHTING PRODUCTS	1	144
STQUAD	STANDARD WHITE ACCESSORIES	1	62
SURF235EMHF	HIGH FREQUENCY MODULAR & FLUORESCENT FITTINGS	1	178
SURF235HF	HIGH FREQUENCY MODULAR & FLUORESCENT FITTINGS	1	178
SURF236EMHF	HIGH FREQUENCY MODULAR & FLUORESCENT FITTINGS	1	178
SURF236HF	HIGH FREQUENCY MODULAR & FLUORESCENT FITTINGS	1	178
SURF258EMHF	HIGH FREQUENCY MODULAR & FLUORESCENT FITTINGS	1	178
SURF258HF	HIGH FREQUENCY MODULAR & FLUORESCENT FITTINGS	1	178
SURF270EMHF	HIGH FREQUENCY MODULAR & FLUORESCENT FITTINGS	1	178
SURF270HF	HIGH FREQUENCY MODULAR & FLUORESCENT FITTINGS	1	178
SURF414EMHF	HIGH FREQUENCY MODULAR & FLUORESCENT FITTINGS	1	177
SURF414HF	HIGH FREQUENCY MODULAR & FLUORESCENT FITTINGS	1	177
SURF418EMHF	HIGH FREQUENCY MODULAR & FLUORESCENT FITTINGS	1	177
SURF418HF	HIGH FREQUENCY MODULAR & FLUORESCENT FITTINGS	1	177
SURF436EMHF	HIGH FREQUENCY MODULAR & FLUORESCENT FITTINGS	1	177
SURF436HF	HIGH FREQUENCY MODULAR & FLUORESCENT FITTINGS	1	177
SW127	WIRING ACCESSORIES	20	64

Code	Catalogue Section	Qty	Pg
ST6300	STANDARD WHITE ACCESSORIES	10	67
SW501C	LIGHTING PRODUCTS	1	134
SW501W	LIGHTING PRODUCTS	1	134
SX7051WH	DATA COMMS ACCESSORIES	1	73
SX7052WH	DATA COMMS ACCESSORIES	1	73
SX7206BK	DATA COMMS ACCESSORIES	1	73
SX7208BK	DATA COMMS ACCESSORIES	1	73
SX7210BK	DATA COMMS ACCESSORIES	2	73

## T

Code	Catalogue Section	Qty	Pg
T02	TRANSFORMERS/DRIVERS	1	246
T03	TRANSFORMERS/DRIVERS	1	246
T04	TRANSFORMERS/DRIVERS	1	246
T410	LIGHTING PRODUCTS	1	142
T410TUBE	LAMPS	25	245
T416	LIGHTING PRODUCTS	1	142
T416TUBE	LAMPS	25	245
T420	LIGHTING PRODUCTS	1	142
T420TUBE	LAMPS	25	245
T425	LIGHTING PRODUCTS	1	142
T425TUBE	LAMPS	25	245
T430	LIGHTING PRODUCTS	1	142
T430TUBE	LAMPS	25	245
T46A	LIGHTING PRODUCTS	1	142
T46ATUBE	LAMPS	25	245
T46TUBE	LAMPS	25	245
T5114	BATTENS	4	184
T5128	BATTENS	4	184
T5128EM	BATTENS	1	184
T5135	BATTENS	4	184
T5135EM	BATTENS	1	184
T514	LIGHTING PRODUCTS	1	142
T5149	BATTENS	4	184
T5149EM	BATTENS	1	184
T514TUBE	LAMPS	25	245
T521	LIGHTING PRODUCTS	1	142
T5214	BATTENS	4	184
T521TUBE	LAMPS	25	245
T5228	BATTENS	4	184
T5228EM	BATTENS	1	184
T5235	BATTENS	4	184
T5235EM	BATTENS	1	184
T5249	BATTENS	4	184
T5249EM	BATTENS	1	184
T528	LIGHTING PRODUCTS	1	142
T528TUBE	LAMPS	20	245
T535	LIGHTING PRODUCTS	1	142
T535TUBE	LAMPS	10	245
T56	LIGHTING PRODUCTS	1	142
T56TUBE	LAMPS	25	245
T58	LIGHTING PRODUCTS	1	142
T58TUBE	LAMPS	25	245

# A-Z INDEX

Code	Catalogue Section	Qty	Pg
T5DIF2	BATTENS	2	184
T5DIF4	BATTENS	2	184
T5DIF5	BATTENS	2	184
T8118HF	BATTENS	1	182
T8136EMHF	BATTENS	1	182
T8136HF	BATTENS	4	182
T8158EMHF	BATTENS	1	182
T8158HF	BATTENS	4	182
T8170EMHF	BATTENS	1	182
T8170HF	BATTENS	4	182
T8218HF	BATTENS	4	182
T8236EMHF	BATTENS	1	182
T8236HF	BATTENS	4	182
T8258EMHF	BATTENS	1	182
T8258HF	BATTENS	4	182
T8270EMHF	BATTENS	1	182
T8270HF	BATTENS	4	182
T8BLED12	LED BATTEN	1	185
T8BLED14	LED BATTEN	1	185
T8BLED15	LED BATTEN	1	185
T8BLED15EM	LED BATTEN	1	185
T8BLED16	LED BATTEN	1	185
T8BLED16EM	LED BATTEN	1	185
T8BLED22	LED BATTEN	1	185
T8BLED24	LED BATTEN	1	185
T8BLED25	LED BATTEN	1	185
T8BLED25EM	LED BATTEN	1	185
T8BLED26	LED BATTEN	1	185
T8BLED26EM	LED BATTEN	1	185
T8DIFF136	BATTENS	2	182
T8DIFF158	BATTENS	2	182
T8DIFF170	BATTENS	2	182
T8DIFF236	BATTENS	2	182
T8DIFF258	BATTENS	2	182
T8DIFF270	BATTENS	2	182
T8LB14	LED BATTEN	4	183
T8LB15	LED BATTEN	4	183
T8LB16	LED BATTEN	4	183
T8LB24	LED BATTEN	4	183
T8LB25	LED BATTEN	4	183
T8LB26	LED BATTEN	4	183
T8LED4	LED LAMPS	1	183
T8LED4D	LED LAMPS	1	183
T8LED5	LED LAMPS	1	183
T8LED5D	LED LAMPS	1	183
T8LED6	LED LAMPS	1	183
T8LED6D	LED LAMPS	1	183
T8REF36	BATTENS	4	182
T8REF58	BATTENS	4	182
T8REF70	BATTENS	4	182
TE1	TOOLS & TEST EQUIPMENT	1	104
TE10	TOOLS & TEST EQUIPMENT	1	106
TE11	TOOLS & TEST EQUIPMENT	1	106
TE13	TOOLS & TEST EQUIPMENT	1	106

Code	Catalogue Section	Qty	Pg
TE14	TOOLS & TEST EQUIPMENT	1	106
TE15	TOOLS & TEST EQUIPMENT	1	106
TE2	TOOLS & TEST EQUIPMENT	1	104
TE3	TOOLS & TEST EQUIPMENT	1	104
TE4	TOOLS & TEST EQUIPMENT	1	104
TE5	TOOLS & TEST EQUIPMENT	1	106
TE6	TOOLS & TEST EQUIPMENT	1	105
TE7	TOOLS & TEST EQUIPMENT	1	105
TE8	TOOLS & TEST EQUIPMENT	1	105
TL110	OUTDOOR LIGHTING	1	206
TL230	OUTDOOR LIGHTING	1	206
TP28W2DCEMHF	BULKHEADS	1	198
TP28W2DCHF	BULKHEADS	1	198
TP28W2DEMHF	BULKHEADS	1	198
TP28W2DHF	BULKHEADS	1	198
TP38W2DCHF	BULKHEADS	1	198
TP38W2DHF	BULKHEADS	1	198
TPB14EMLED	LED BULKHEADS	1	195
TPB14EMSLED	LED BULKHEADS	1	195
TPB14LED	LED BULKHEADS	1	195
TPB14SLED	LED BULKHEADS	1	195
TPB16BRRG	BULKHEADS	1	197
TPB16CHRG	BULKHEADS	1	197
TPB16WHRG	BULKHEADS	1	197
TPB16WOHF	BULKHEADS	1	197
TPB16WPHF	BULKHEADS	1	197
TPB28EMPL	EMERGENCY LIGHTING	1	248
TPB28MSEMHF	BULKHEADS	1	196
TPB28MSHF	BULKHEADS	1	196
TPB28WOEMHF	BULKHEADS	1	196
TPB28WOHF	BULKHEADS	1	196
TPB28WPEMHF	BULKHEADS	1	196
TPB28WPHF	BULKHEADS	1	196
TPB33BRRG	BULKHEADS	1	196
TPB33CHRG	BULKHEADS	1	196
TPB33MSRG	BULKHEADS	1	196
TPB33WHRG	BULKHEADS	1	196
TPB38WOHF	BULKHEADS	1	197
TPB38WPHF	BULKHEADS	1	197
TPOV60B	BULKHEADS	1	200
TPOV60W	BULKHEADS	1	200
TPR14LED	LED BULKHEADS	1	198
TPR14LEDEM	LED BULKHEADS	1	198
TPR14LEDS	LED BULKHEADS	1	198
TPR16BOHF	BULKHEADS	1	199
TPR16BPHF	BULKHEADS	1	199
TPR16WOHF	BULKHEADS	1	199
TPR16WPHF	BULKHEADS	1	199
TPR28B0HF	BULKHEADS	1	199
TPR28BPHF	BULKHEADS	1	199
TPR28WOEMHF	BULKHEADS	1	199
TPR28WOHF	BULKHEADS	1	199
TPR28WPEMHF	BULKHEADS	1	199
TPR28WPHF	BULKHEADS	1	199

## A-Z INDEX

Code	Catalogue Section	Qty	Pg
TPS28BOEMHF	BULKHEADS	1	199
TPS28BOHF	BULKHEADS	1	199
TPS28BPEMHF	BULKHEADS	1	199
TPS28BPHF	BULKHEADS	1	199
TPS28WOEMHF	BULKHEADS	1	199
TPS28WOHF	BULKHEADS	1	199
TPS28WPEMHF	BULKHEADS	1	199
TPS28WPHF	BULKHEADS	1	199
TR150HQI	COMMERCIAL LIGHTING	1	208
TR250HB	COMMERCIAL LIGHTING	1	208
TR250SH	COMMERCIAL LIGHTING	1	208
TR250SLB	COMMERCIAL LIGHTING	1	208
TR400SH	COMMERCIAL LIGHTING	1	208
TR400SLB	COMMERCIAL LIGHTING	1	208
TR651181HF	COMMERCIAL LIGHTING	1	189
TR65118HF	COMMERCIAL LIGHTING	1	187
TR65136EMHF	COMMERCIAL LIGHTING	1	187
TR65136HF	COMMERCIAL LIGHTING	1	187
TR651581EMHF	COMMERCIAL LIGHTING	1	189
TR651581HF	COMMERCIAL LIGHTING	1	189
TR65158EMHF	COMMERCIAL LIGHTING	1	187
TR65158HF	COMMERCIAL LIGHTING	1	187
TR65170EMHF	COMMERCIAL LIGHTING	1	187
TR65170HF	COMMERCIAL LIGHTING	1	187
TR652181EMHF	COMMERCIAL LIGHTING	1	189
TR652181HF	COMMERCIAL LIGHTING	1	189
TR65218EMHF	COMMERCIAL LIGHTING	1	187
TR65218HF	COMMERCIAL LIGHTING	1	187
TR65236EMHF	COMMERCIAL LIGHTING	1	187
TR65236HF	COMMERCIAL LIGHTING	1	187
TR652581EMHF	COMMERCIAL LIGHTING	1	189
TR652581HF	COMMERCIAL LIGHTING	1	189
TR65258EMHF	COMMERCIAL LIGHTING	1	187
TR65258HF	COMMERCIAL LIGHTING	1	187
TR65270EMHF	COMMERCIAL LIGHTING	1	187
TR65270HF	COMMERCIAL LIGHTING	1	187
TR70HQI	COMMERCIAL LIGHTING	1	208
TRHP70	COMMERCIAL LIGHTING	1	207
TRHP70PC	COMMERCIAL LIGHTING	1	207
TRI01C	LIGHTING PRODUCTS	1	144
TRI01CBR	LIGHTING PRODUCTS	1	144
TRIGX53CBR	LIGHTING PRODUCTS	1	144
TRK1MBK	TRACK AND SPOT LIGHTING	1	155
TRK1MS	TRACK AND SPOT LIGHTING	1	155
TRK1MW	TRACK AND SPOT LIGHTING	1	155
TRK2MBK	TRACK AND SPOT LIGHTING	1	155
TRK2MS	TRACK AND SPOT LIGHTING	1	155
TRK2MW	TRACK AND SPOT LIGHTING	1	155
TRK3MBK	TRACK AND SPOT LIGHTING	1	155
TRK3MS	TRACK AND SPOT LIGHTING	1	155
TRK3MW	TRACK AND SPOT LIGHTING	1	155
TRKCBK	TRACK AND SPOT LIGHTING	1	155
TRKCS	TRACK AND SPOT LIGHTING	1	155
TRKCW	TRACK AND SPOT LIGHTING	1	155

Code	Catalogue Section	Qty	Pg
TRKDEBK	TRACK AND SPOT LIGHTING	1	155
TRKDES	TRACK AND SPOT LIGHTING	1	155
TRKDEW	TRACK AND SPOT LIGHTING	1	155
TRKFCBK	TRACK AND SPOT LIGHTING	1	155
TRKFCFS	TRACK AND SPOT LIGHTING	1	155
TRKFCW	TRACK AND SPOT LIGHTING	1	155
TRKLBCBK	TRACK AND SPOT LIGHTING	1	155
TRKLCS	TRACK AND SPOT LIGHTING	1	155
TRKLCW	TRACK AND SPOT LIGHTING	1	155
TRKPFBK	TRACK AND SPOT LIGHTING	1	155
TRKPFS	TRACK AND SPOT LIGHTING	1	155
TRKPFW	TRACK AND SPOT LIGHTING	1	155
TRKRABK	TRACK AND SPOT LIGHTING	1	155
TRKRAS	TRACK AND SPOT LIGHTING	1	155
TRKRAW	TRACK AND SPOT LIGHTING	1	155
TRKSP1BC	TRACK AND SPOT LIGHTING	1	154
TRKSP1BK	TRACK AND SPOT LIGHTING	1	154
TRKSP1W	TRACK AND SPOT LIGHTING	1	154
TRKSP2BC	TRACK AND SPOT LIGHTING	1	154
TRKSP2BK	TRACK AND SPOT LIGHTING	1	154
TRKSP2W	TRACK AND SPOT LIGHTING	1	154
TRKSP3BC	TRACK AND SPOT LIGHTING	1	154
TRKSP3BK	TRACK AND SPOT LIGHTING	1	154
TRKSP3W	TRACK AND SPOT LIGHTING	1	154
TRKSP4BC	TRACK AND SPOT LIGHTING	1	154
TRKSP4BK	TRACK AND SPOT LIGHTING	1	154
TRKSP4W	TRACK AND SPOT LIGHTING	1	154
TRKTBK	TRACK AND SPOT LIGHTING	1	155
TRKTS	TRACK AND SPOT LIGHTING	1	155
TRKTW	TRACK AND SPOT LIGHTING	1	155
TRKXBK	TRACK AND SPOT LIGHTING	1	155
TRKXS	TRACK AND SPOT LIGHTING	1	155
TRKXW	TRACK AND SPOT LIGHTING	1	155
TRPC150	COMMERCIAL LIGHTING	1	207
TRPC250	COMMERCIAL LIGHTING	1	207
TRPC400	COMMERCIAL LIGHTING	1	207
TRPC70	COMMERCIAL LIGHTING	1	207
TRPCKIT	SENSORS	1	118
TRRPC	SENSORS	1	118
TRW70	COMMERCIAL LIGHTING	1	207
TRW70PC	COMMERCIAL LIGHTING	1	207

## U

Code	Catalogue Section	Qty	Pg
UC1000	LED LIGHTING	1	141
UC250	LED LIGHTING	1	141
UC500	LED LIGHTING	1	141
UCCUP	LED LIGHTING	5	141
UCLED13	LED LIGHTING	2	141
UCLED13W3K	LED LIGHTING	2	141
UCLED18	LED LIGHTING	2	141
UCLED18W3K	LED LIGHTING	2	141
UCLED22	LED LIGHTING	2	141
UCLED22W3K	LED LIGHTING	2	141

Code	Catalogue Section	Qty	Pg
UCLED4	LED LIGHTING	1	141
UCLED4W3K	LED LIGHTING	1	141
UCLED9	LED LIGHTING	1	141
UCLED9W3K	LED LIGHTING	1	141
UCP200	LED LIGHTING	1	141

**V**

Code	Catalogue Section	Qty	Pg
VFR400M	WIRING ACCESSORIES	1	121
VFR7EM	FIRE-RATED LED AND ACCESSORIES	1	120
VFR8BEZBL	FIRE-RATED LED AND ACCESSORIES	1	122
VFR8BEZBR	FIRE-RATED LED AND ACCESSORIES	1	122
VFR8BEZCBR	FIRE-RATED LED AND ACCESSORIES	1	122
VFR8BEZCH	FIRE-RATED LED AND ACCESSORIES	1	122
VFR8BEZMW	FIRE-RATED LED AND ACCESSORIES	1	122
VFR8CW	FIRE-RATED LED AND ACCESSORIES	1	122
VFR8TBEZBL	FIRE-RATED LED AND ACCESSORIES	1	123
VFR8TBEZBR	FIRE-RATED LED AND ACCESSORIES	1	123
VFR8TBEZCBR	FIRE-RATED LED AND ACCESSORIES	1	123
VFR8TBEZCH	FIRE-RATED LED AND ACCESSORIES	1	123
VFR8TBEZMW	FIRE-RATED LED AND ACCESSORIES	1	123
VFR8TCW	FIRE-RATED LED AND ACCESSORIES	1	123
VFR8TWW	FIRE-RATED LED AND ACCESSORIES	1	123
VFR8WW	FIRE-RATED LED AND ACCESSORIES	1	122
VFRBEZAB	FIRE-RATED LED AND ACCESSORIES	1	120
VFRBEZBK	FIRE-RATED LED AND ACCESSORIES	1	120
VFRBEZBR	FIRE-RATED LED AND ACCESSORIES	1	120
VFRBEZCBR	FIRE-RATED LED AND ACCESSORIES	1	120
VFRBEZCH	FIRE-RATED LED AND ACCESSORIES	1	120
VFRBEZGM	FIRE-RATED LED AND ACCESSORIES	1	120
VFRBEZMW	FIRE-RATED LED AND ACCESSORIES	1	120
VFRBEZW	FIRE-RATED LED AND ACCESSORIES	1	120
VFRCBC	FIRE-RATED LED AND ACCESSORIES	1	121
VFRCC	FIRE-RATED LED AND ACCESSORIES	1	121
VFRCL02C	FIRE-RATED DOWNLIGHTS AND ACCESSORIES	1	129

Code	Catalogue Section	Qty	Pg
VFRCL02CBR	FIRE-RATED DOWNLIGHTS AND ACCESSORIES	1	129
VFRCL02W	FIRE-RATED DOWNLIGHTS AND ACCESSORIES	1	129
VFRCLG06C	FIRE-RATED DOWNLIGHTS AND ACCESSORIES	1	129
VFRCLG06CBR	FIRE-RATED DOWNLIGHTS AND ACCESSORIES	1	129
VFRCLG06W	FIRE-RATED DOWNLIGHTS AND ACCESSORIES	1	129
VFRCOBCW	FIRE-RATED LED AND ACCESSORIES	1	120
VFRCOBCW1	FIRE-RATED LED AND ACCESSORIES	1	121
VFRCOBCW2	FIRE-RATED LED AND ACCESSORIES	1	121
VFRCOBCW3	FIRE-RATED LED AND ACCESSORIES	1	121
VFRCOBWW	FIRE-RATED LED AND ACCESSORIES	1	120
VFRCOBWW1	FIRE-RATED LED AND ACCESSORIES	1	121
VFRCOBWW2	FIRE-RATED LED AND ACCESSORIES	1	121
VFRCOBWW3	FIRE-RATED LED AND ACCESSORIES	1	121
VFRCW	FIRE-RATED LED AND ACCESSORIES	1	121
VFRDGICB	FIRE-RATED DOWNLIGHTS AND ACCESSORIES	1	127
VFRDGICC	FIRE-RATED DOWNLIGHTS AND ACCESSORIES	1	127
VFRDGICCBR	FIRE-RATED DOWNLIGHTS AND ACCESSORIES	1	127
VFRDGICW	FIRE-RATED DOWNLIGHTS AND ACCESSORIES	1	127
VFRSBEZBK	FIRE-RATED LED AND ACCESSORIES	1	120
VFRSBEZCBR	FIRE-RATED LED AND ACCESSORIES	1	120
VFRSBEZCH	FIRE-RATED LED AND ACCESSORIES	1	120
VFRSBEZW	FIRE-RATED LED AND ACCESSORIES	1	120
VFRSGICB	FIRE-RATED DOWNLIGHTS AND ACCESSORIES	1	127
VFRSGICC	FIRE-RATED DOWNLIGHTS AND ACCESSORIES	1	127
VFRSGICCBR	FIRE-RATED DOWNLIGHTS AND ACCESSORIES	1	127
VFRSGICW	FIRE-RATED DOWNLIGHTS AND ACCESSORIES	1	127
VFRSH01C	FIRE-RATED DOWNLIGHTS AND ACCESSORIES	1	130
VFRSH01CBR	FIRE-RATED DOWNLIGHTS AND ACCESSORIES	1	130
VFRSH01W	FIRE-RATED DOWNLIGHTS AND ACCESSORIES	1	130
VFRSHGICB	FIRE-RATED DOWNLIGHTS AND ACCESSORIES	1	128
VFRSHGICC	FIRE-RATED DOWNLIGHTS AND ACCESSORIES	1	128

## A-Z INDEX

<b>Code</b>	<b>Catalogue Section</b>	<b>Qty</b>	<b>Pg</b>
VFRSHGICBR	FIRE-RATED DOWNLIGHTS AND ACCESSORIES	1	128
VFRSHGICW	FIRE-RATED DOWNLIGHTS AND ACCESSORIES	1	128
VFRSHLEC	FIRE-RATED DOWNLIGHTS AND ACCESSORIES	1	130
VFRSHLECBR	FIRE-RATED DOWNLIGHTS AND ACCESSORIES	1	130
VFRSHLEW	FIRE-RATED DOWNLIGHTS AND ACCESSORIES	1	130

## W

<b>Code</b>	<b>Catalogue Section</b>	<b>Qty</b>	<b>Pg</b>
W50LV	OUTDOOR LIGHTING	1	217
W5420	WIRING ACCESSORIES	1	65
WALL1	OUTDOOR LIGHTING	1	211
WALL1L	OUTDOOR LIGHTING	1	211
WALL1LBK	OUTDOOR LIGHTING	1	211
WALL2	OUTDOOR LIGHTING	1	210
WALL2L	OUTDOOR LIGHTING	1	210
WALL2LBK	OUTDOOR LIGHTING	1	210
WALL3	OUTDOOR LIGHTING	1	211
WALL3L	OUTDOOR LIGHTING	1	211
WALL3LBK	OUTDOOR LIGHTING	1	211
WGULED	OUTDOOR LIGHTING	1	217
WGULEN	OUTDOOR LIGHTING	1	216
WHGULED	OUTDOOR LIGHTING	1	216
WSGULED	OUTDOOR LIGHTING	1	216

## X

<b>Code</b>	<b>Catalogue Section</b>	<b>Qty</b>	<b>Pg</b>
XT468	DATACOMMS ACCESSORIES	1	75
XT500BX	DATACOMMS ACCESSORIES	1	75
XT901BX	DATACOMMS ACCESSORIES	1	75







# HOW TO ORDER

Phone: **+44 (0) 1582 88 77 60**

Email: **orders@mlaccessories.co.uk**

Fax: **+44 (0) 1582 88 77 61**

Online: **www.mlaccessories.co.uk**

Technical Helpline: **+44 (0) 1582 88 77 68**

Accounts: **+44 (0) 1582 88 77 66**

Distributed by:

**+44 (0) 1582 88 77 60**

Email your order on:  
**orders@mlaccessories.co.uk**

Fax your order on:  
**+44 (0) 1582 88 77 61**  
next day delivery as standard

Order online at:  
**www.mlaccessories.co.uk**



Unit 4 & 5, Foster Avenue, Woodside Park, Dunstable, Bedfordshire LU5 5TA