

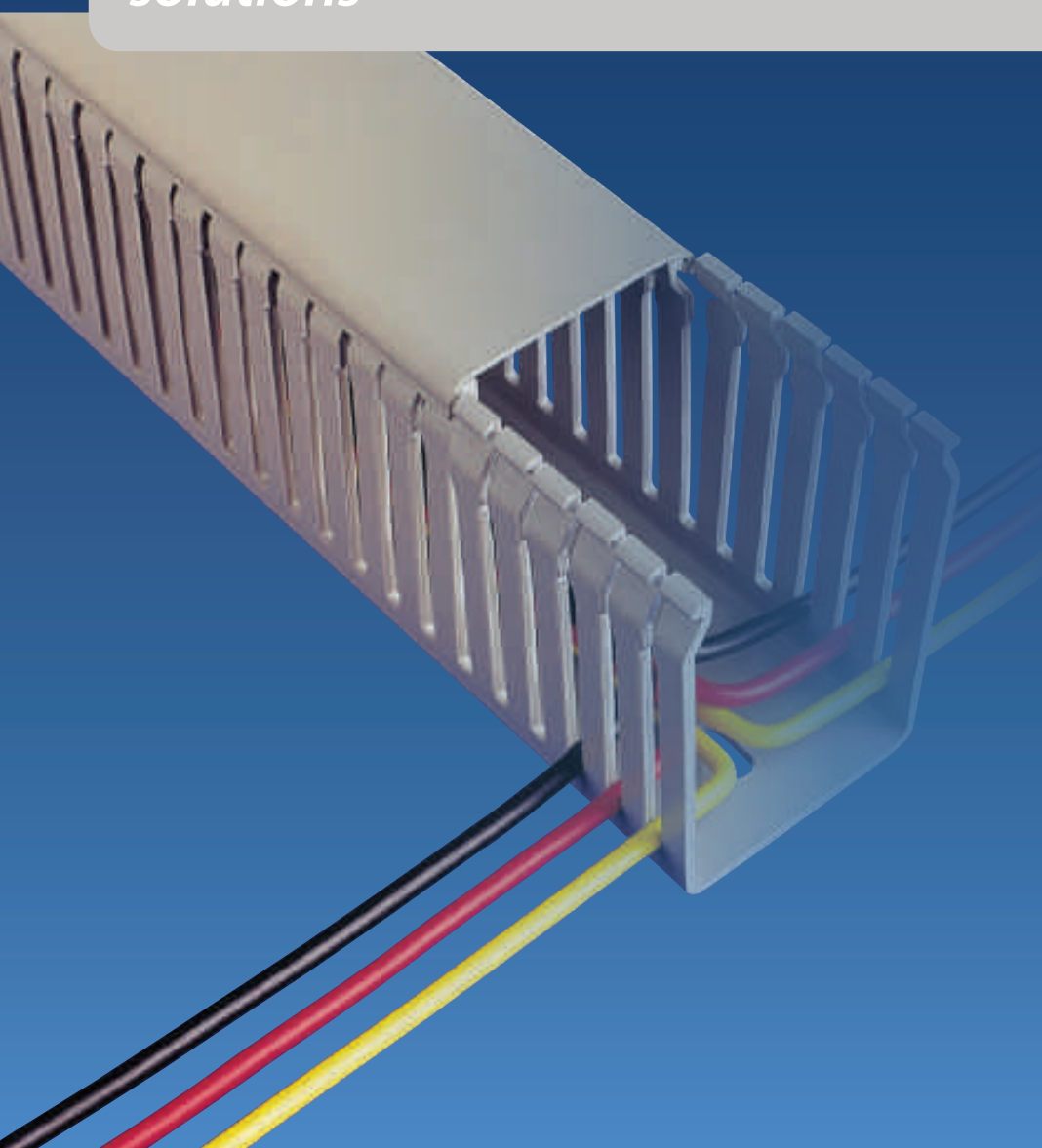

Betaduct control panel trunking solutions

Manufactured in the UK, cuLUs approved Betaduct trunking includes PVC, halogen-free and Noryl options, complete with a wide-range of matched accessories and tooling.



Introduction to Betaduct

The Betaduct range	594
Why choose Betaduct	594

Betaduct PVC trunking

PVC open slot trunking	596
PVC closed slot trunking	601
PVC narrow slot trunking	605
PVC solid wall trunking	610
PVC open and closed slot mini packs	612
PVC open slot duo packs	613
PVC spare lids	614
PVC flexi-duct	615

Betaduct halogen-free trunking

HFN narrow slot trunking	617
Noryl open slot trunking	618
Noryl closed slot trunking	619
Noryl narrow slot trunking	620
Noryl spare lids	622

Betaduct Noryl Extra halogen-free trunking

Noryl Extra open slot trunking	624
Noryl Extra closed slot trunking	625
Noryl Extra solid wall trunking	626
Noryl Extra spare lids	626

Betaduct tools and accessories

Cutting and notching tools	628
Accessories	629

Betaduct Metric trunking

PVC open slot metric trunking	636
PVC narrow open slot metric trunking	639
Accessories	642

Technical information

Betaduct capacity chart	632
Betaduct for the rail industry	633
Betaduct metric capacity chart	644

Betaduct



Betaduct, situated in Tewkesbury, Gloucestershire, is the manufacturing base for the world-renowned Betaduct PVC and LFH control panel trunking, which has been in production for over 40 years.

In 2009, Cablecraft Ltd acquired Betaduct and, went on to successfully launch two new products; grey halogen-free trunking and, by special request, blue halogen-free trunking.



The Betaduct range

Recent launches include metric open and narrow slot trunking, Betaduct halogen-free 2044, Betaduct halogen-free closed slot and Betaduct Noryl Extra.

Our portfolio comprises of Betaduct PVC and halogen-free trunking, Noryl halogen-free trunking, Betaduct metric trunking and Betaduct preparation tools and accessories. Our products are available throughout the world in countries including Australia, New Zealand, North America, Sweden, Italy, UAE and Poland. In addition we are constantly breaking into new markets throughout Europe and Asia.

Every product in the expanding range is designed to meet the needs of original equipment manufacturers, installers, panel builders and system integrators. Their superior quality reflects product compliance with all major national and international standards.



Why choose Betaduct?

Quality guaranteed

As the only UK manufacturer of control panel trunking, we only use the highest grade PVC and Noryl materials in our manufacturing process, to ensure consistent quality.

Manufactured in the UK

Our highly qualified and skilled technicians have trained for many years in the plastic extrusion industry.

Online stock check facility

Quickly check stock on all products. The in-stock indicator shows current stock levels and availability, visit www.cablecraft.co.uk.

cULus approved

Our products are only manufactured from UL/CSA approved raw material. Our plant is subject to a regular inspection from the UL/CSA certification authority to ensure their standards are thoroughly met.

Industry recognised

Our products are recognised for their quality and suitability to be used in a range of applications including marine, offshore and industrial applications.

Widest product range available

We offer the most extensive range of control panel trunking available anywhere, and with our wide selection of sizes can cater for all applications.





Betaduct PVC open slot trunking

Betaduct PVC open slot provides lightweight self-extinguishing cable trunking with excellent rigidity and performance characteristics. Wide fingers give additional cable support and terminated wires can be re-routed easily. Ideal for use when bundles, cables and wires need supporting in control panels, distribution boards and switchgear. Ideal for all panel building applications. Available in 23 sizes.

Recommended fixing method – Betaduct rivets or washers. Supplied with lid.

Product features

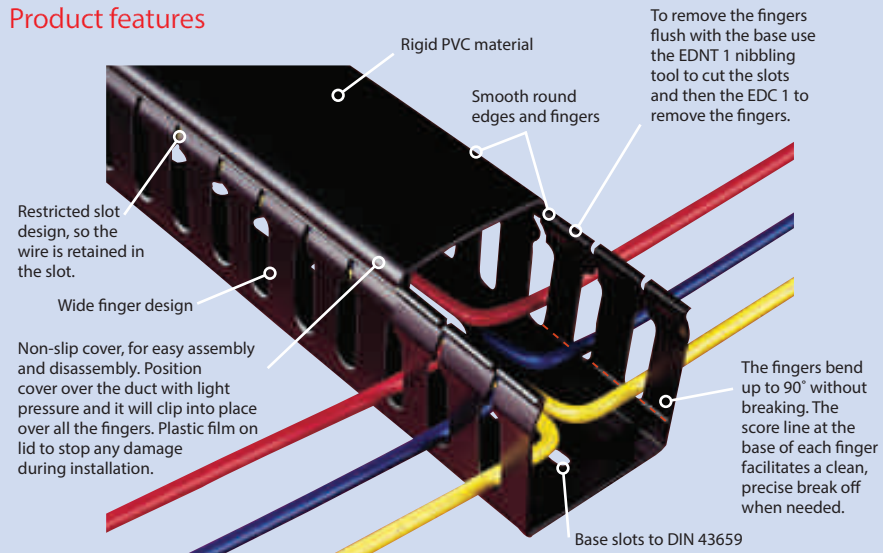

Feature	Benefit
Rigid PVC material	Self-extinguishing PVC.
Wide finger design	To give additional cable support. The wide fingers can be used with a range of wire and bundle sizes.
Restricted slot design	Saves time during installation, once wires are installed they will remain in the slot with or without cover.
Non-slip cover	Once installed lid will not slip. Easy clip-on assembly and disassembly. Plastic film on lid to stop any damage during installation. On 75mm lids and above; non-slip adhesive to ensure lid retention.
Base slots to DIN 43659	Staggered mounting holes, conforms to DIN standard.
Score line at base of each slot	Fingers bend up to 90° without breaking. The score line facilitates a clean, precise break off when needed.
Smooth round edges	Free from burrs or sharp edges that could lead to abrasions on hands and cables.
Associated cutting tools - EDNT 1, EDC 1	For clean, precise cutting of trunking fingers.

Betaduct PVC open slot - Grey

Betaduct PVC open slot provides lightweight self-extinguishing cable trunking with excellent rigidity and performance characteristics. Wide fingers give additional cable support and terminated wires can be re-routed easily.

Available in 23 sizes. Recommended fixing method – Betaduct rivets or washers. Supplied with lid.

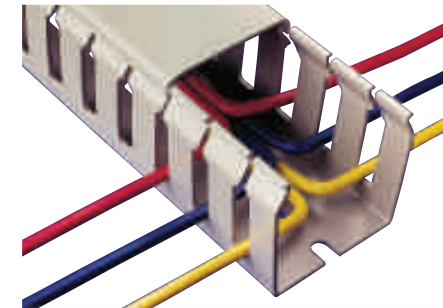

SPECIFICATIONS

Material Self-extinguishing PVC

Slot pitch 20mm, **Slot width** 8mm, **Webs** 12mm

Colour Grey RAL 7030

Service temperature rating -15°C to +60°C

Flammability UL94 V-0 Rated material

Standards Base slots to DIN 43659. RoHS 2 and UL approved: UL E161178A

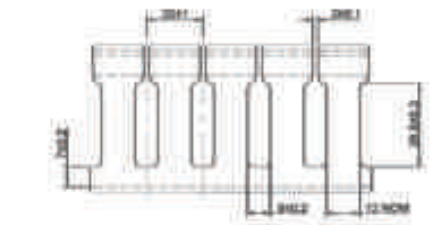

Grey open slot trunking

Part number	Nominal size inner (WxH) mm	Nominal size outer (WxH) mm	Pack qty (m)
10450018	19 x 50	25 x 53	24
10450022	25 x 37.5	29 x 41	24
10450023	25 x 50	29 x 54	24
10450024	25 x 75	29 x 79	16
10450025	25 x 100	30 x 105	16
10450032	37.5 x 37.5	41 x 41	24
10450033	37.5 x 50	41 x 54	16
10450034	37.5 x 75	39 x 79	16
10450035	37.5 x 100	43 x 105	16
10450051	50 x 25	54 x 28	24
10450052	50 x 37.5	54 x 41	16
10450053	50 x 50	54 x 54	16
10450054	50 x 75	55 x 79	16
10450055	50 x 100	56 x 105	8
10450072	75 x 37.5	80 x 41	16
10450073	75 x 50	78 x 54	16
10450074	75 x 75	80 x 80	16
10450075	75 x 100	80 x 105	8
10450103	100 x 50	107 x 54	8
10450104	100 x 75	107 x 80	8
10450105	100 x 100	107 x 104	8
10450106	100 x 125	107 x 130	8
10450124	125 x 75	131 x 78	8

BETADUCT TOOLING See page 628

EDNT 1 Nibbling tool **EDC 1 Cutting tool**



Control panel trunking

Control panel trunking



Betaduct PVC open slot - Black

Betaduct PVC open slot provides lightweight self-extinguishing cable trunking with excellent rigidity and performance characteristics. Wide fingers give additional cable support and terminated wires can be re-routed easily. Ideal for use when bundles, cables and wires need supporting in control panels, distribution boards and switchgear. Ideal for all panel building applications.

Available in 23 sizes. Recommended fixing method – Betaduct rivets or washers. Supplied with lid.

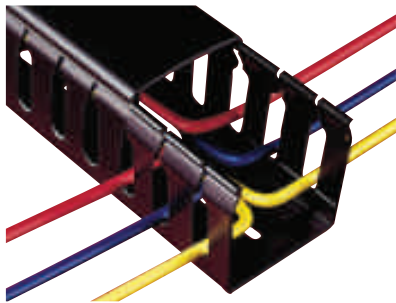

SPECIFICATIONS

Material Self-extinguishing PVC
Slot pitch 20mm
Slot width 8mm
Webs 12mm
Colour Black RAL 9005
Service temperature rating -15°C to +60°C
Flammability UL94 V-0 Rated material
Standards Base slots to DIN 43659.
 RoHS 2 and UL approved: UL E161178A

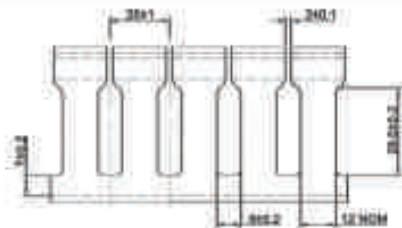

Black open slot trunking			
Part number	Nominal size inner (WxH) mm	Nominal size outer (WxH) mm	Pack qty (m)
09800000	19 x 50	25 x 53	24
09810000	25 x 37.5	29 x 41	24
09130000	25 x 50	29 x 54	24
09140000	25 x 75	29 x 79	16
09830000	25 x 100	30 x 105	16
09840000	37.5 x 37.5	41 x 41	24
09850000	37.5 x 50	41 x 54	16
09860000	37.5 x 75	39 x 79	16
09870000	37.5 x 100	43 x 105	16
09880000	50 x 25	54 x 28	24
09890000	50 x 37.5	54 x 41	16
09160000	50 x 50	54 x 54	16
09170000	50 x 75	55 x 79	16
09920000	50 x 100	56 x 105	8
09930000	75 x 37.5	80 x 41	16
09940000	75 x 50	78 x 54	16
09190000	75 x 75	80 x 80	16
09960000	75 x 100	80 x 105	8
09980000	100 x 50	107 x 54	8
09990000	100 x 75	107 x 80	8
10000000	100 x 100	107 x 104	8
10010000	100 x 125	107 x 130	8
09410000	125 x 75	131 x 78	8



Betaduct PVC open slot - Blue

Betaduct PVC open slot provides lightweight self-extinguishing cable trunking with excellent rigidity and performance characteristics. Wide fingers give additional cable support and terminated wires can be re-routed easily. Suitable for I.S. circuits.

Available in 13 sizes. Recommended fixing method – Betaduct rivets or washers. Supplied with lid.



Blue open slot trunking			
Part number	Nominal size inner (WxH) mm	Nominal size outer (WxH) mm	Pack qty (m)
09136000	25 x 50	29 x 54	24
09146000	25 x 75	29 x 79	16
09836000	25 x 100	30 x 105	16
09856000	37.5 x 50	41 x 54	16
09866000	37.5 x 75	39 x 79	16
09876000	37.5 x 100	43 x 105	16
09166000	50 x 50	54 x 54	16
09176000	50 x 75	55 x 79	16
09926000	50 x 100	56 x 105	8
09196000	75 x 75	80 x 80	16
09966000	75 x 100	80 x 105	8
09996000	100 x 75	107 x 80	8
10006000	100 x 100	107 x 104	8

SPECIFICATIONS

Material Self-extinguishing PVC
Slot pitch 20mm
Slot width 8mm
Webs 12mm
Colour Blue RAL 5015
Service temperature rating -15°C to +60°C
Flammability UL94 V-0 Rated material
Standards Base slots to DIN 43659.
 RoHS 2 and UL approved: UL E161178A

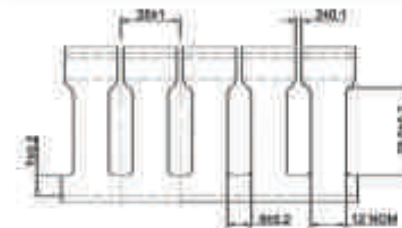



Betaduct PVC open slot - White

Betaduct PVC open slot provides lightweight self-extinguishing cable trunking with excellent rigidity and performance characteristics. Wide fingers give additional cable support and terminated wires can be re-routed easily. Ideal for use when bundles, cables and wires need supporting in control panels, distribution boards and switchgear. Ideal for all panel building applications.

Available in 23 sizes. Recommended fixing method – Betaduct rivets or washers. Supplied with lid.

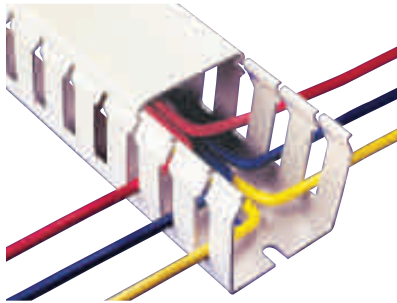

SPECIFICATIONS

- Material** Self-extinguishing PVC
- Slot pitch** 20mm
- Slot width** 8mm
- Webs** 12mm
- Colour** White
- Service temperature rating** -15°C to +60°C
- Flammability** UL94 V-0 Rated material
- Standards** Base slots to DIN 43659. RoHS 2 and UL approved: UL E161178A

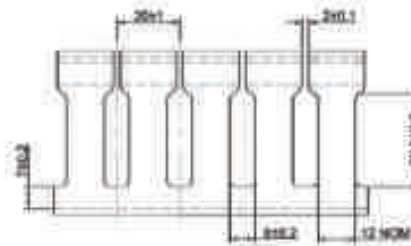

White open slot trunking			
Part number	Nominal size inner (WxH) mm	Nominal size outer (WxH) mm	Pack qty (m)
23610110	19 x 50	25 x 53	24
23610400	25 x 37.5	29 x 41	24
23610500	25 x 50	29 x 54	24
23610600	25 x 75	29 x 79	16
23610700	25 x 100	30 x 105	16
23610900	37.5 x 37.5	41 x 41	24
23611000	37.5 x 50	41 x 54	16
23611100	37.5 x 75	39 x 79	16
23611200	37.5 x 100	43 x 105	16
23611300	50 x 25	54 x 28	24
23611400	50 x 37.5	54 x 41	16
23611500	50 x 50	54 x 54	16
23611600	50 x 75	55 x 79	16
23611700	50 x 100	56 x 105	8
23611800	75 x 37.5	80 x 41	16
23611900	75 x 50	78 x 54	16
23612000	75 x 75	80 x 80	16
23612100	75 x 100	80 x 105	8
23612400	100 x 50	107 x 54	8
23612500	100 x 75	107 x 80	8
23612600	100 x 100	107 x 104	8
23612900	125 x 75	131 x 78	8
23613000	100 x 125	107 x 130	8



Betaduct PVC closed slot trunking

Betaduct PVC closed slot provides lightweight self-extinguishing cable trunking with excellent rigidity and performance characteristics. Wide fingers give additional cable support and terminated wires can be re-routed easily. Ideal for use when bundles, cables and wires need supporting in control panels, distribution boards and switchgear. Ideal for all panel building applications. Available in a range of sizes. Recommended fixing method; Betaduct rivets or washers. Supplied with lid.

Product features

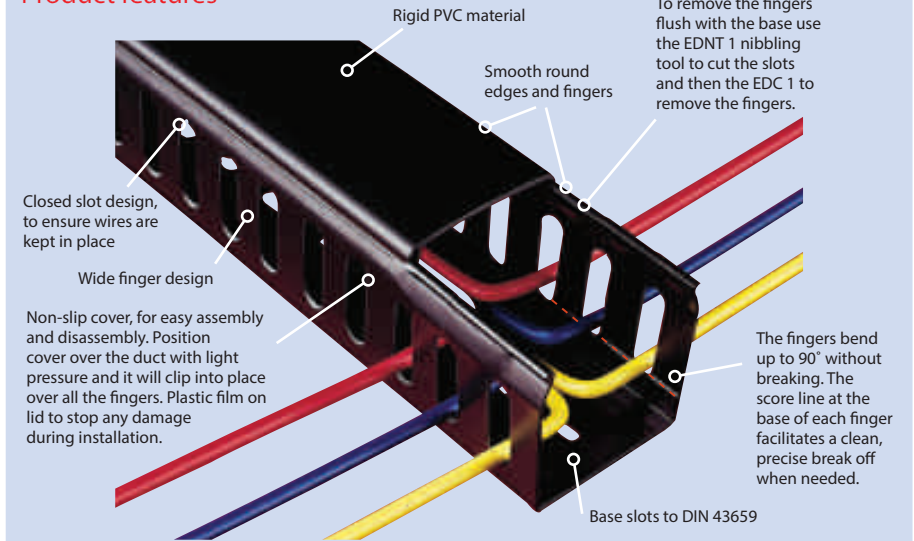

Feature	Benefit
Rigid PVC material	Self-extinguishing PVC.
Wide finger design	To give additional cable support. The wide fingers can be used with a range of wire and bundle sizes.
Closed slot design	Saves time during installation, once wires are installed they will remain in the slot with or without cover.
Non-slip cover	Once installed lid will not slip. Easy clip-on assembly and disassembly. Plastic film on lid to prevent damage during installation.
Base slots to DIN 43659	Staggered mounting holes, conforms to DIN standard.
Score line at base of each slot	Fingers bend up to 90° without breaking. The score line facilitates a clean, precise break off when needed.
Smooth round edges	Free from burrs or sharp edges that could lead to abrasions on hands and cables.
Associated cutting tools - EDNT 1, EDC 1	For clean, precise cutting of trunking fingers.



Betaduct PVC closed slot trunking - Grey

Betaduct PVC closed slot provides lightweight self-extinguishing cable trunking with excellent rigidity and performance characteristics. Wide fingers give additional cable support and terminated wires can be re-routed easily. Ideal for use when bundles, cables and wires need supporting in control panels, distribution boards and switchgear. Ideal for all panel building applications.

Available in 25 sizes. Recommended fixing method; Betaduct rivets or washers. Supplied with lid.



SPECIFICATIONS

Material Self-extinguishing PVC
Slot pitch 20mm, **Slot width** 8mm, **Webs** 12mm
Colour Grey RAL 7030
Service temperature rating -15°C to +60°C
Flammability UL94 V-0 Rated material
Standards Base slots to DIN 43659.
 RoHS 2 and UL approved: UL E161178A

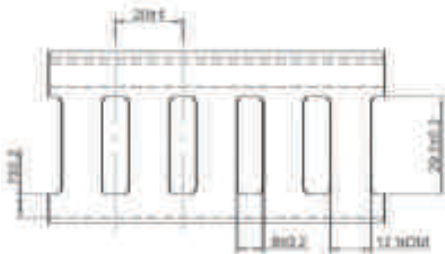

Grey closed slot trunking			
Part number	Nominal size inner (WxH) mm	Nominal size outer (WxH) mm	Pack qty (m)
10460011	15 x 15	17 x 17	48
10460018	19 x 50	25 x 53	24
10460021	25 x 20	29 x 23	24
10460022	25 x 37.5	29 x 41	24
10460023	25 x 50	29 x 54	24
10460024	25 x 75	29 x 79	16
10460025	25 x 100	30 x 105	16
10460032	37.5 x 37.5	41 x 41	24
10460033	37.5 x 50	41 x 54	16
10460034	37.5 x 75	39 x 79	16
10460035	37.5 x 100	43 x 105	16
10460051	50 x 25	54 x 28	24
10460052	50 x 37.5	54 x 41	16
10460053	50 x 50	54 x 54	16
10460054	50 x 75	55 x 79	16
10460055	50 x 100	56 x 105	8
10460072	75 x 37.5	80 x 41	16
10460073	75 x 50	78 x 54	16
10460074	75 x 75	80 x 80	16
10460075	75 x 100	80 x 105	8
10460103	100 x 50	107 x 54	8
10460104	100 x 75	107 x 80	8
10460105	100 x 100	107 x 104	8
10460106	100 x 125	107 x 130	8
10460124	125 x 75	131 x 78	8



Betaduct PVC closed slot trunking - Black

Betaduct PVC closed slot provides lightweight self-extinguishing cable trunking with excellent rigidity and performance characteristics. Wide fingers give additional cable support and terminated wires can be re-routed easily. Ideal for use when bundles, cables and wires need supporting in control panels, distribution boards and switchgear. Ideal for all panel building applications.

Available in 24 sizes. Recommended fixing method – Betaduct rivets or washers. Supplied with lid.

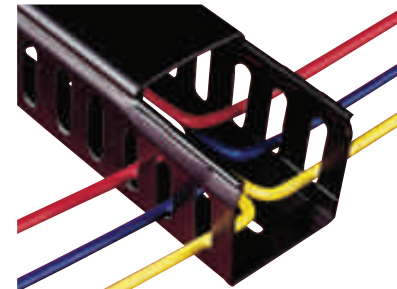

SPECIFICATIONS

Material Self-extinguishing PVC
Slot pitch 20mm **Slot width** 8mm **Webs** 12mm
Colour Black RAL 9005
Service temperature rating -15°C to +60°C
Flammability UL94 V-0 Rated material
Standards Base slots to DIN 43659.
 RoHS 2 and UL approved: UL E161178A

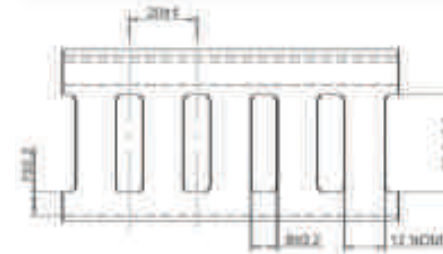

Black closed slot trunking			
Part number	Nominal size inner (WxH) mm	Nominal size outer (WxH) mm	Pack qty (m)
09000000	15 x 15	17 x 17	48
09500000	19 x 50	25 x 53	24
09010000	25 x 20	29 x 23	24
09510000	25 x 37.5	29 x 41	24
09030000	25 x 50	29 x 54	24
09040000	25 x 75	29 x 79	16
09530000	25 x 100	30 x 105	16
09540000	37.5 x 37.5	41 x 41	24
09550000	37.5 x 50	41 x 54	16
09560000	37.5 x 75	39 x 79	16
09570000	37.5 x 100	43 x 105	16
09380000	50 x 25	54 x 28	24
09590000	50 x 37.5	54 x 41	16
09060000	50 x 50	54 x 54	16
09070000	50 x 75	55 x 79	16
09620000	50 x 100	56 x 105	8
09640000	75 x 50	78 x 54	16
09090000	75 x 75	80 x 80	16
09660000	75 x 100	80 x 105	8
09680000	100 x 50	107 x 54	8
09690000	100 x 75	107 x 80	8
09700000	100 x 100	107 x 104	8
09710000	100 x 125	107 x 130	8
09400000	125 x 75	131 x 78	8

BETADUCT TOOLING See page 628



EDNT 1 Nibbling tool

EDC 1 Cutting tool



Betaduct PVC closed slot trunking - White

Betaduct PVC closed slot provides lightweight self-extinguishing cable trunking with excellent rigidity and performance characteristics. Wide fingers give additional cable support and terminated wires can be re-routed easily. Ideal for use when bundles, cables and wires need supporting in control panels, distribution boards and switchgear. Ideal for all panel building applications.

Available in 23 sizes. Recommended fixing method; Betaduct rivets or washers. Supplied with lid.



SPECIFICATIONS

Material Self-extinguishing PVC
Slot pitch 20mm
Slot width 8mm
Webs 12mm
Colour White
Service temperature rating -15°C to +60°C
Flammability UL94 V-0 Rated material
Standards Base slots to DIN 43659.
 RoHS 2 and UL approved: UL E161178A

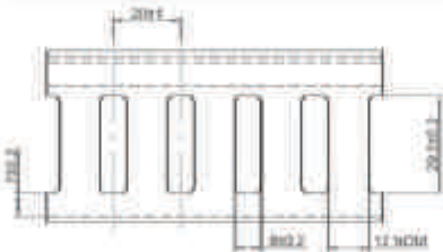

White closed slot trunking			
Part number	Nominal size inner (WxH) mm	Nominal size outer (WxH) mm	Pack qty (m)
23600100	15 x 15	17 x 17	48
23600110	19 x 50	25 x 53	24
23600200	25 x 20	29 x 23	24
23600400	25 x 37.5	29 x 41	24
23600500	25 x 50	29 x 54	24
23600600	25 x 75	29 x 79	16
23600700	25 x 100	30 x 105	16
23600900	37.5 x 37.5	41 x 41	24
23601000	37.5 x 50	41 x 54	16
23601100	37.5 x 75	39 x 79	16
23601300	50 x 25	54 x 28	24
23601400	50 x 37.5	54 x 41	16
23601500	50 x 50	54 x 54	16
23601600	50 x 75	55 x 79	16
23601700	50 x 100	56 x 105	8
23601800	75 x 37.5	80 x 41	16
23601900	75 x 50	78 x 54	16
23602000	75 x 75	80 x 80	16
23602100	75 x 100	80 x 105	8
23602400	100 x 50	107 x 54	8
23602500	100 x 75	107 x 80	8
23602600	100 x 100	107 x 104	8
23602900	125 x 75	131 x 78	8



Betaduct PVC narrow slot trunking

Betaduct PVC narrow slot provides lightweight self-extinguishing cable trunking with excellent rigidity and performance characteristics. Restricted slot design ensures wire is retained in the slot. Ideal for use with slimmer terminal blocks where more access is required, it improves appearance of panels with cables out in best position. Recommended fixing method; Betaduct rivets or washers. Supplied with lid.

Product features

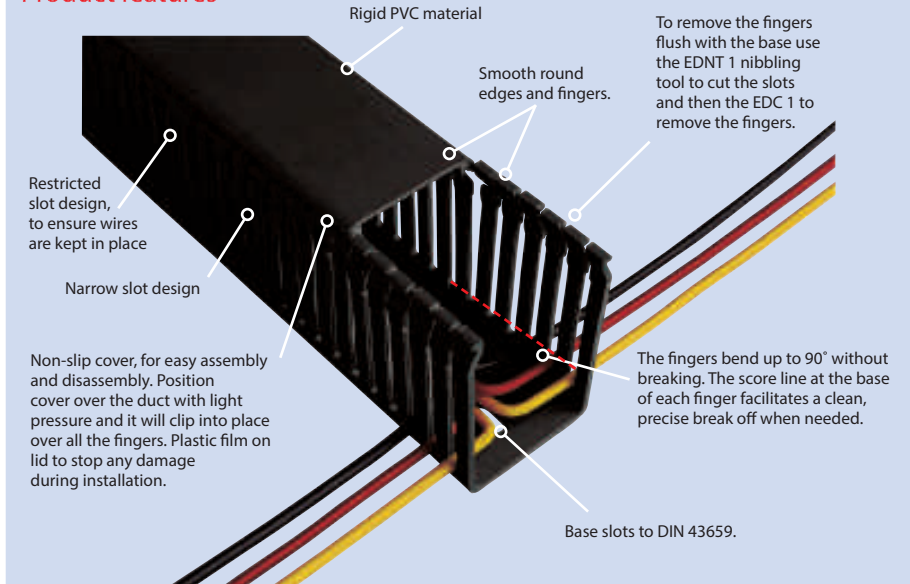

Feature	Benefit
Rigid PVC material	Self-extinguishing PVC.
Restricted slot design	Saves time during installation, once wires are installed they will remain in the slot with or without cover.
Narrow slot design	Provides closer spacing for use with high density applications.
Non-slip cover	Once installed lid will not slip. Easy clip-on assembly and disassembly. Plastic film on lid to stop any damage during installation.
Base slots to DIN 43659	Staggered mounting holes, conforms to DIN standard.
Score line at base of each slot	Fingers bend up to 90° without breaking. The score line facilitates a clean, precise break off when needed.
Smooth round edges	Free from burrs or sharp edges that could lead to abrasions on hands and cables.
Associated cutting tools - EDNT 1, EDC 1	For clean, precise cutting of trunking fingers.



Betaduct PVC narrow slot trunking - Grey

Betaduct PVC narrow slot provides a lightweight self-extinguishing cable trunking with excellent rigidity and performance characteristics. Ideal for use with slimmer terminal blocks where more access is required. For use when bundles, cables and wires need supporting in control panels, distribution boards and switchgear. Ideal for all panel building applications.

Available in 20 sizes. Recommended fixing method; Betaduct rivets or washers. Supplied with lid.

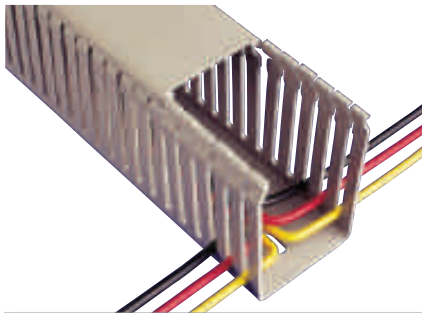

SPECIFICATIONS

Material Self-extinguishing PVC
Slot pitch 10mm **Slot width** 4mm **Webs** 6mm
Colour Grey RAL 7030
Service temperature rating -15°C to +60°C
Flammability UL94 V-0 Rated material
Standards Base slots to DIN 43659.
 RoHS 2 and UL approved: UL E161178A

Grey narrow slot trunking			
Part number	Nominal size inner (WxH) mm	Nominal size outer (WxH) mm	Pack qty (m)
10470018	19 x 50	25 x 53	24
10470022	25 x 37.5	29 x 41	24
10470023	25 x 50	29 x 54	24
10470024	25 x 75	29 x 79	16
10470025	25 x 100	30 x 105	16
10470032	37.5 x 37.5	41 x 41	24
10470033	37.5 x 50	41 x 54	16
10470034	37.5 x 75	41 x 79	16
10470035	37.5 x 100	43 x 105	16
10470052	50 x 37.5	54 x 41	16
10470053	50 x 50	54 x 54	16
10470054	50 x 75	55 x 79	16
10470055	50 x 100	56 x 105	8
10470072	75 x 37.5	80 x 41	16
10470073	75 x 50	78 x 54	16
10470074	75 x 75	80 x 80	16
10470075	75 x 100	80 x 105	8
10470103	100 x 50	107 x 54	8
10470104	100 x 75	107 x 80	8
10470105	100 x 100	107 x 104	8



Betaduct PVC narrow slot trunking - Black

Betaduct PVC narrow slot provides a lightweight self-extinguishing cable trunking with excellent rigidity and performance characteristics. Ideal for use with slimmer terminal blocks where more access is required. For use when bundles, cables and wires need supporting in control panels, distribution boards and switchgear. Ideal for all panel building applications.

Available in 20 sizes. Recommended fixing method; Betaduct rivets or washers. Supplied with lid.

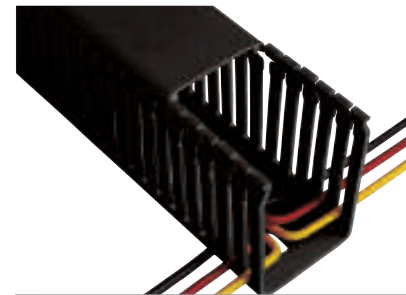

SPECIFICATIONS

Material Self-extinguishing PVC
Slot pitch 10mm **Slot width** 4mm **Webs** 6mm
Colour Black RAL 9005
Service temperature rating -15°C to +60°C
Flammability UL94 V-0 Rated material
Standards Base slots to DIN 43659.
 RoHS 2 and UL approved: UL E161178A

Black narrow slot trunking			
Part number	Nominal size inner (WxH) mm	Nominal size outer (WxH) mm	Pack qty (m)
10490018	19 x 50	25 x 53	24
10490022	25 x 37.5	29 x 41	24
10490023	25 x 50	29 x 54	24
10490024	25 x 75	29 x 79	16
10490025	25 x 100	30 x 105	16
10490032	37.5 x 37.5	41 x 41	24
10490033	37.5 x 50	41 x 54	16
10490034	37.5 x 75	39 x 79	16
10490035	37.5 x 100	43 x 105	16
10490052	50 x 37.5	54 x 41	16
10490053	50 x 50	54 x 54	16
10490054	50 x 75	55 x 79	16
10490055	50 x 100	56 x 105	16
10490072	75 x 37.5	80 x 41	16
10490073	75 x 50	78 x 54	16
10490074	75 x 75	80 x 80	16
10490075	75 x 100	80 x 105	8
10490103	100 x 50	107 x 54	8
10490104	100 x 75	107 x 80	8
10490105	100 x 100	107 x 104	8

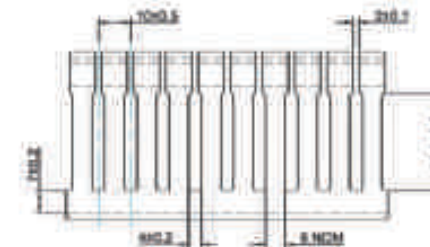

BETADUCT TOOLING See page 628



EDNT 1 Nibbling tool

EDC 1 Cutting tool



Betaduct PVC narrow slot metric trunking - Blue

Betaduct PVC narrow slot provides a lightweight self-extinguishing cable trunking with excellent rigidity and performance characteristics. For use when bundles, cables and wires need supporting in control panels, distribution boards and switchgear. Ideal for all panel building applications, also suitable for I.S circuits.

Available in 16 sizes. Recommended fixing method; Betaduct rivets or washers. Supplied with lid.

SPECIFICATIONS

Material Self-extinguishing PVC
Slot pitch 10mm **Slot width** 4mm **Webs** 6mm
Colour Blue RAL 5015
Service temperature rating -5°C to +65°C
Flammability UL94 V-0 Rated material
Standards Base slots to DIN 43659.
 RoHS 2 and UL approved: UL E161178A



CROSS SECTIONS

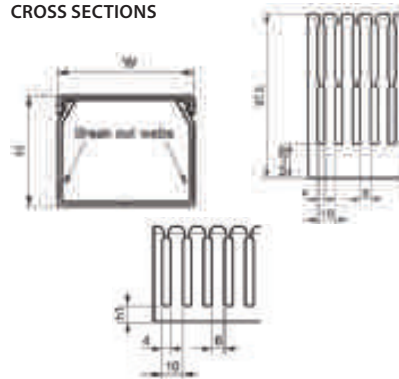

BASE PUNCHING

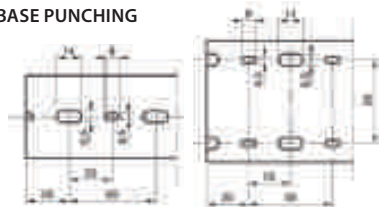

Blue narrow slot trunking

Part number	Nominal size outer (WxH) mm	Pack qty (m)
104760024	20 x 42	48
104760032	30 x 23	48
104760034	30 x 42	48
104760036	30 x 60	48
104760038	30 x 80	24
104760044	43 x 42	24
104760046	43 x 60	24
104760048	43 x 80	24
104760064	60 x 42	24
104760066	60 x 60	24
104760068	60 x 80	24
104760610	60 x 100	24
104760086	80 x 60	24
104760088	80 x 80	24
1047601010	100 x 100	12
104760126	120 x 60	12

Spare lids

Part number	Width (mm)	Pack qty (m)
104760001	20	48
104760002	30	24
104760003	40	24
104760004	60	24
104760005	80	24
104760006	100	12
104760007	120	12

Betaduct PVC narrow slot trunking - White

Betaduct PVC narrow slot provides a lightweight self-extinguishing cable trunking with excellent rigidity and performance characteristics. Ideal for use with slimmer terminal blocks where more access is required, it improves appearance of panels with cables out in the best position. For use when bundles, cables and wires need supporting in control panels, distribution boards and switchgear. Ideal for all panel building applications.

Available in 20 sizes. Recommended fixing method – Betaduct rivets or washers. Supplied with lid.



SPECIFICATIONS

Material Self-extinguishing PVC
Slot pitch 10mm **Slot width** 4mm **Webs** 6mm
Colour White
Service temperature rating -15°C to +60°C
Flammability UL94 V-0 Rated material
Standards Base slots to DIN 43659.
 RoHS 2 and UL approved: UL E161178A

White narrow slot trunking

Part number	Nominal size inner (WxH) mm	Nominal size outer (WxH) mm	Pack qty (m)
23630110	19 x 50	25 x 53	24
23630400	25 x 37.5	29 x 41	24
23630500	25 x 50	29 x 54	24
23630600	25 x 75	29 x 79	16
23630700	25 x 100	30 x 105	16
23630900	37.5 x 37.5	41 x 41	24
23631000	37.5 x 50	41 x 54	16
23631100	37.5 x 75	39 x 79	16
23631200	37.5 x 100	43 x 105	16
23631400	50 x 37.5	54 x 41	16
23631500	50 x 50	54 x 54	16
23631600	50 x 75	55 x 79	16
23631700	50 x 100	56 x 105	8
23631800	75 x 37.5	80 x 41	16
23631900	75 x 50	78 x 54	16
23632000	75 x 75	80 x 80	16
23632100	75 x 100	80 x 105	8
23632400	100 x 50	107 x 54	8
23632500	100 x 75	107 x 80	8
23632600	100 x 100	107 x 104	8

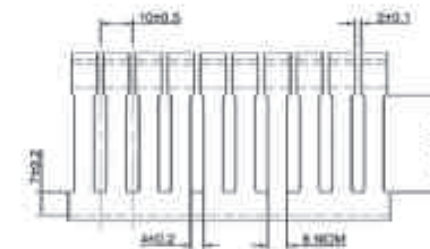



Betaduct PVC solid wall trunking

Betaduct PVC solid wall provides a lightweight self-extinguishing cable trunking with excellent rigidity and performance characteristics. Solid wall design fully encloses cables providing maximum protection. Ideal for use where little or no breakouts are required when bundles, cables and wires need supporting in control panels, distribution boards and switchgear.

Betaduct PVC solid wall trunking - Grey

Available in 25 sizes. Recommended fixing method – Betaduct rivets or washers. Supplied with lid.



SPECIFICATIONS

Material Self-extinguishing PVC

Colour Grey RAL 7035

Service temperature rating -15°C to +60°C

Flammability UL94 V-0 Rated material

Standards Base slots to DIN 43659. RoHS 2 and UL approved: UL E161178A



Grey solid wall trunking			
Part number	Nominal size inner (WxH) mm	Nominal size outer (WxH) mm	Pack quantity (m)
10480011	15 x 15	17 x 17	48
10480018	19 x 50	25 x 53	24
10480021	25 x 20	29 x 23	24
10480022	25 x 37.5	29 x 41	24
10480023	25 x 50	29 x 54	24
10480024	25 x 75	29 x 79	16
10480025	25 x 100	30 x 105	16
10480032	37.5 x 37.5	41 x 41	24
10480033	37.5 x 50	41 x 54	16
10480034	37.5 x 75	39 x 79	16
10480035	37.5 x 100	43 x 105	16
10480051	50 x 25	54 x 28	24
10480052	50 x 37.5	54 x 41	16
10480053	50 x 50	54 x 54	16
10480054	50 x 75	55 x 79	16
10480055	50 x 100	56 x 105	8
10480072	75 x 37.5	80 x 41	16
10480073	75 x 50	78 x 54	16
10480074	75 x 75	80 x 80	16
10480075	75 x 100	80 x 105	8
10480103	100 x 50	107 x 54	8
10480104	100 x 75	107 x 80	8
10480105	100 x 100	107 x 104	8
10480106	100 x 125	107 x 130	8
10480124	125 x 75	131 x 78	8



Betaduct PVC solid wall trunking - Black

Available in 25 sizes. Recommended fixing method – Betaduct rivets or washers. Supplied with lid.



SPECIFICATIONS

Material Self-extinguishing PVC

Colour Black RAL 9005

Service temperature rating -15°C to +60°C

Flammability UL94 V-0 Rated material

Standards Base slots to DIN 43659. RoHS 2 and UL approved: UL E161178A



Black solid wall trunking			
Part number	Nominal size inner (WxH) mm	Nominal size outer (WxH) mm	Pack qty (m)
09200000	15 x 15	17 x 17	48
10100000	19 x 50	25 x 53	24
09210000	25 x 20	29 x 23	24
10110000	25 x 37.5	29 x 41	24
09230000	25 x 50	29 x 54	24
09240000	25 x 75	29 x 79	16
10130000	25 x 100	30 x 105	16
10140000	37.5 x 37.5	41 x 41	24
10150000	37.5 x 50	41 x 54	16
10160000	37.5 x 75	39 x 79	16
10170000	37.5 x 100	43 x 105	16
10180000	50 x 25	54 x 28	24
10190000	50 x 37.5	54 x 41	16
09260000	50 x 50	54 x 54	16
09270000	50 x 75	55 x 79	16
10220000	50 x 100	56 x 105	8
10230000	75 x 37.5	80 x 41	16
10240000	75 x 50	78 x 54	16
09290000	75 x 75	80 x 80	16
10260000	75 x 100	80 x 105	8
10280000	100 x 50	107 x 54	8
10290000	100 x 75	107 x 80	8
10300000	100 x 100	107 x 104	8
10310000	100 x 125	107 x 130	8
09420000	125 x 75	131 x 78	8

BETADUCT TOOLING See page 628



EDNT 1 Nibbling tool



EDC 1 Cutting tool



Betaduct PVC trunking - mini packs

Betaduct PVC open and closed slot mini packs

Betaduct PVC provides a lightweight self-extinguishing cable trunking with excellent rigidity and performance characteristics.

Supplied with lid, in handy mini packs containing 4 x 1 metre lengths. Ideal for smaller installations.

SPECIFICATIONS				
Material	Self-extinguishing PVC			
Colour	Grey RAL 7030, Black RAL 9005			
Service temperature rating	-15°C to +60°C			
Flammability	UL94 V-0 Rated material			
Standards	Base slots to DIN 43659. RoHS 2 and UL approved: UL E161178A			

Open slot mini packs Grey

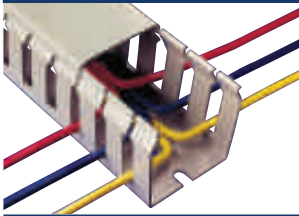

Part number	Nominal size inner (WxH) mm	Nominal size outer (WxH) mm	Pack quantity (m)
10452022	25 x 37.5	29 x 41	4 x 1m lengths
10452023	25 x 50	29 x 54	4 x 1m lengths
10452051	50 x 25	54 x 28	4 x 1m lengths
10452053	50 x 50	54 x 54	4 x 1m lengths

Open slot mini packs Black

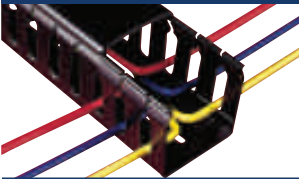

Part number	Nominal size inner (WxH) mm	Nominal size outer (WxH) mm	Pack quantity (m)
08862000	25 x 37.5	29 x 41	4 x 1m lengths
08872000	25 x 50	29 x 54	4 x 1m lengths
08882000	50 x 50	54 x 54	4 x 1m lengths

Closed slot mini packs Black

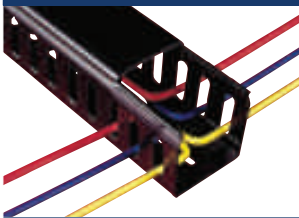

Part number	Nominal size inner (WxH) mm	Nominal size outer (WxH) mm	Pack quantity (m)
08702000	15 x 15	17 x 17	4 x 1m lengths
08712000	25 x 20	29 x 23	4 x 1m lengths
08722000	25 x 50	29 x 54	4 x 1m lengths
08732000	50 x 50	54 x 54	4 x 1m lengths



Betaduct PVC open slot duo packs - Grey

Betaduct PVC open slot provides a lightweight self-extinguishing cable trunking with excellent rigidity and performance characteristics. Wide fingers give additional cable support and terminated wires can be re-routed easily. Supplied in handy duo packs, containing 2 x 2 metre lengths.

Supplied with lid. Recommended fixing method; rivets and washers.

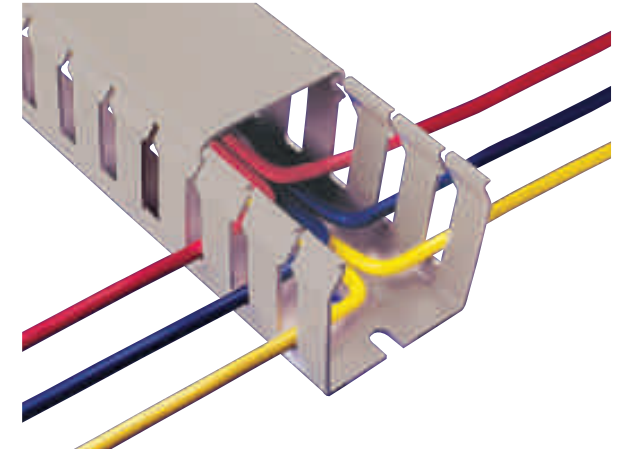

SPECIFICATIONS	
Material	Self-extinguishing PVC
Colour options	Grey RAL 7030
Service temperature rating	-15°C to +60°C
Flammability	UL94 V-0 Rated material
Standards	Base slots to DIN 43659. CE, RoHS 2, UL E161178A.

Grey open slot trunking			
Part number	Nominal size inner (WxH) mm	Nominal size outer (WxH) mm	Pack quantity (m)
30450023	25 x 50	29 x 54	2 x 2m
30450024	25 x 75	29 x 79	2 x 2m
30450053	50 x 50	54 x 54	2 x 2m
30450054	50 x 75	55 x 79	2 x 2m
30450074	75 x 75	80 x 80	2 x 2m
30450104	100 x 75	107 x 80	2 x 2m
30450124	125 x 75	131 x 78	2 x 2m

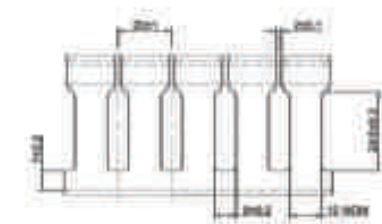



Betaduct PVC spare lids

Betaduct spare lids are made from a self-extinguishing PVC material, and are available in grey, black, blue or white.

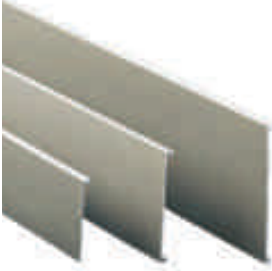

SPECIFICATIONS						
Material	Self-extinguishing PVC					
Colour options	Grey RAL 7030, Black RAL 9005, Blue RAL 5015, White					
Service temperature rating	-15°C to +60°C					
Flammability	UL94 V-0 Rated material					
Standards	Base slots to DIN 43659. RoHS 2, CSA, and UL approved.					

Betaduct spare lids						
	Part no. Grey	Part no. Black	Part no. Blue	Part no. White	Width (mm)	Pack qty (m)
	10450001	09310000	--	--	15	24
	10450019	09310019	--	23620019	19	24
	10450002	09330000	09336000	23620003	25	24
	10450003	09320000	10456003	23620004	37.5	24
	10450004	09340000	09346000	23620005	50	24
	10450005	09350000	09356000	23620006	75	24
	10450006	09360000	10456006	23620007	100	12
	10450007	09370000	--	23620008	125	12

Control panel trunking



Beta PVC Flexi-Duct

Beta Flexi-Duct is a flexible cable routing system designed for use in control panels, distribution boards, or in difficult to reach areas. Cables can be routed in or out over the whole length. Mounted either with screws, using the DIN standard base punching, or with the self-adhesive strip on the back. It's possible to install the flexi-duct at 90° angles for increased flexibility. Available in round and square sections.

Beta Flexi-Duct - Round type

Round Flexi-Duct			
Part number	Colour	Internal dia. (mm)	Pack qty (m)
GMF-20T	Grey	20	2 x 0.5
GMF-30T	Grey	30	2 x 0.5
GMF-40T	Grey	40	1 x 0.5

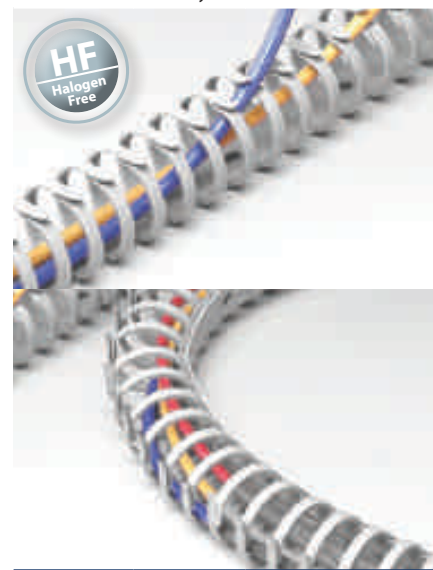

SPECIFICATIONS	
Material	Halogen-free polypropylene
Colour	Grey RAL 7035
Service temperature rating	-40°C to +70°C
Flammability	Flame resistant: UL94 V-2 Rated material

Beta Flexi-Duct - Square type

Square Flexi-Duct			
Part number	Colour	WxH (mm)	Pack qty (m)
GMS-20T	Grey	20 x 20	2 x 0.5
GMS-30T	Grey	30 x 30	2 x 0.5
GMS-40T	Grey	40 x 40	1 x 0.5



SPECIFICATIONS	
Material	Self-extinguishing nylon
Colour	Grey
Service temperature rating	-15°C to +80°C
Flammability	Flame resistant: UL94 V-2 Rated material

Control panel trunking



Betaduct halogen-free trunking

Betaduct halogen-free trunking is manufactured in the UK and is available in the following types:

- **HFN halogen-free trunking** (lightweight, self-extinguishing polyphenylene ether material)
 - Narrow slot, grey
- **Noryl halogen-free trunking**

Betaduct Noryl is made from material which during burning, forms a protective charred 'intumescent' surface layer and, being free from halogen, this Betaduct does not emit harmful products such as hydrochloric acid and chloride gas, which is associated with PVC.

 - Open slot
 - Closed slot
 - Narrow slot
 - Narrow slot, blue
- **Noryl-Extra** is also available, see p.623.

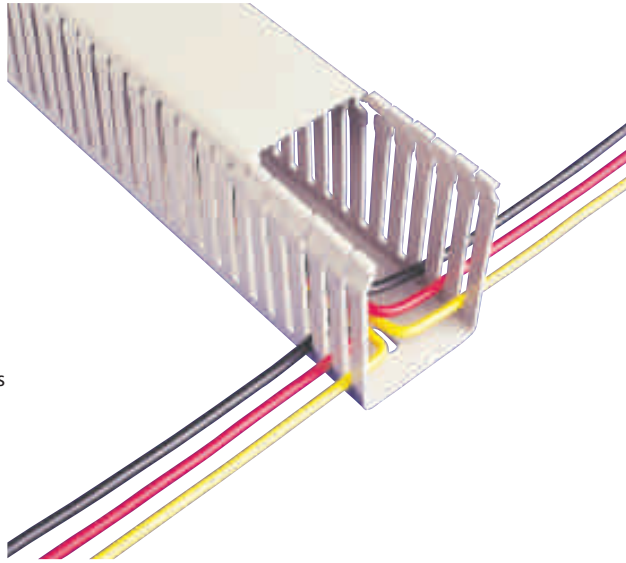

Applications

HFN Betaduct grey halogen-free narrow slot and Betaduct grey halogen-free trunking

For use in locations where public safety is a concern; public buildings, shopping centres, hospitals, airport terminals, stadiums, as well as a variety of hostile environments.



Betaduct blue halogen-free narrow slot trunking

Suitable for I.S circuits and ideal for use in hostile environments, where danger to health is a concern, such as petrochemical plants and offshore oil platforms.



Betaduct HFN halogen-free narrow slot - Grey

New Betaduct HFN halogen-free narrow slot, is manufactured from lightweight self-extinguishing halogen-free polyphenylene ether material. With excellent performance characteristics, it is an ideal solution for bundles, cables and wires that need supporting in control panels, distribution boards and switchgear particularly where more access is required. For use in public buildings, shopping centres, hospitals, airport terminals, stadiums, as well as a variety of hostile environments.



Halogen-free HFN grey narrow slot

Part number	Nominal size inner (WxH) mm	Pack quantity (m)
20440021	25 x 25	24
20440022	25 x 37.5	24
20440023	25 x 50	24
20440024	25 x 75	16
20440032	37.5 x 37.5	24
20440033	37.5 x 50	16
20440034	37.5 x 75	16
20440053	50 x 50	16
20440054	50 x 75	16
20440073	75 x 50	16
20440074	75 x 75	16
20440103	100 x 50	8
20440104	100 x 75	8
20440124	125 x 75	8

SPECIFICATIONS

Material Polyphenylene ether modified (PPE/PS)
Colour Light grey RAL 7035
Service temperature rating -25°C to +70°C
Limiting oxygen index 32.5%
Elongation at yield 5%
Tensile strength at break 40 MPa
Dielectric strength 35kV/mm
Volume resistivity 1 E12 ohm.cm
Flame resistance V1 UL94
Chemical resistance
 Sea salt resistance - no influence.
Standards
 PPE is halogen-free according to DIN/VDE 472. Part 815 – contains no bromine or chlorinate.

BASE PUNCHING

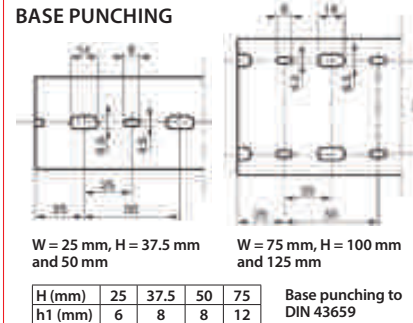

CROSS SECTIONS

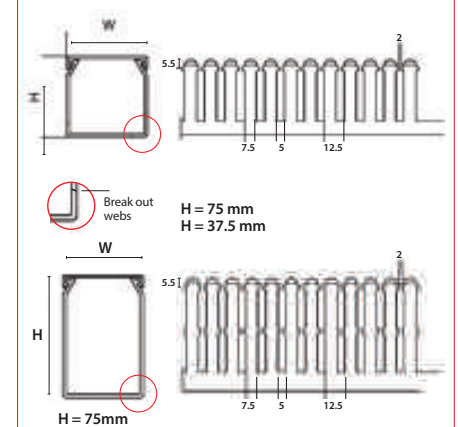



Betaduct Noryl halogen-free open slot - Grey



Betaduct halogen-free open slot is manufactured in the UK from Noryl NH5110E. It provides a lightweight self-extinguishing cable trunking with excellent rigidity and performance characteristics. Wide fingers give additional cable support and terminated wires can be re-routed easily.

Ideal for use in applications where danger to members of the public is a concern such as public buildings, shopping centres, hospitals, airport terminals, stadiums, as well as a variety of hostile environments.

Available in 17 sizes. Recommended fixing method; Betaduct rivets or washers. Supplied with lid.

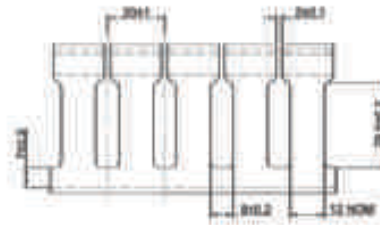
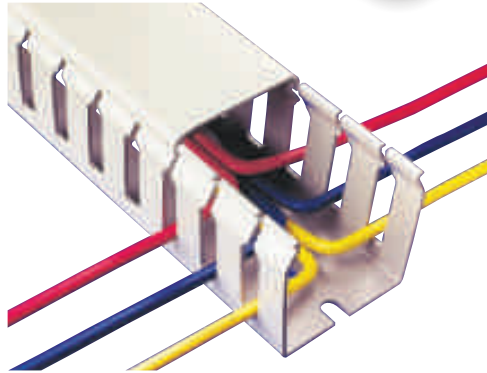

SPECIFICATIONS

Material
Halogen-free Noryl NH5110E

Slot pitch 20mm
Slot width 8mm
Webs 12mm

Colour
Light grey RAL 7035

Service temperature rating
-25°C to +90°C

Oxygen index
35.7% BS EN ISO 4589-2: 1999

Smoke test
BS 6853: 1999 Annex D.8.3 (Small scale smoke emission test)

Flammability UL94 V-1 Rated material

Standards
cULus and UL Approved: UL E161178B



Betaduct Noryl halogen-free closed slot - Grey



Betaduct halogen-free grey closed slot is made from Noryl NH5110E and is a flame retardant, non-halogenated, impact modified extrusion grade polymer. Ideal for use in applications where danger to members of the public is a concern such as public buildings, shopping centres, hospitals, airport terminals, stadiums, as well as a variety of hostile environments. Available in 15 sizes.

Supplied with lid.
Recommended fixing method; rivets and washers.

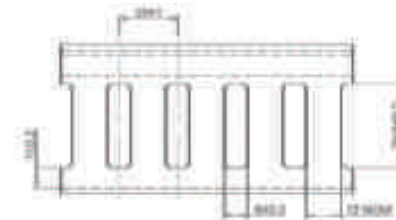

Noryl halogen-free grey closed slot

Part number	Nominal size inner (WxH) mm	Nominal size outer (WxH) mm	Pack qty (m)
20460022	25 x 37.5	29 x 41	24
20460023	25 x 50	29 x 54	24
20460024	25 x 75	29 x 79	16
20460032	37.5 x 37.5	41 x 41	24
20460033	37.5 x 50	41 x 54	16
20460034	37.5 x 75	39 x 79	16
20460053	50 x 50	54 x 54	16
20460054	50 x 75	55 x 79	16
20460055	50 x 100	56 x 105	8
20460073	75 x 50	78 x 54	16
20460074	75 x 75	80 x 80	16
20460075	75 x 100	80 x 105	8
20460104	100 x 75	107 x 80	8
20460103	100 x 50	107 x 54	8
20460105	100 x 100	107 x 104	8

SPECIFICATIONS

Material
Halogen-free Noryl NH5110E

Slot pitch 19mm
Slot width 8mm

Colour
Light grey RAL 7035

Service temperature rating
-25°C to +90°C

Oxygen index
35.7% BS EN ISO 4589-2: 1999

Smoke test
BS 6853: 1999 Annex D.8.3 - (Small scale smoke emission test)

Flammability UL94 V-1 Rated material

Standards
Base slots to DIN 43659. CE, RoHS 2, UL E161178B





Betaduct Noryl halogen-free narrow slot - Grey



Betaduct halogen-free narrow slot is manufactured in the UK from Noryl NH5110E. It provides a lightweight self-extinguishing cable trunking with excellent rigidity and performance characteristics. Ideal for use with slimmer terminal blocks where more access is required, it improves appearance of panels with cables out in best position. For use when bundles, cables and wires need supporting in control panels, distribution boards and switchgear.

Ideal for use in applications where danger to members of the public is a concern such as public buildings, shopping centres, hospitals, airport terminals, stadiums, as well as a variety of hostile environments. Available in 19 sizes. Recommended fixing method; Betaduct rivets or washers. Supplied with lid.

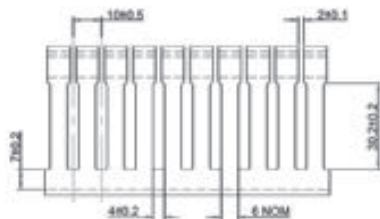
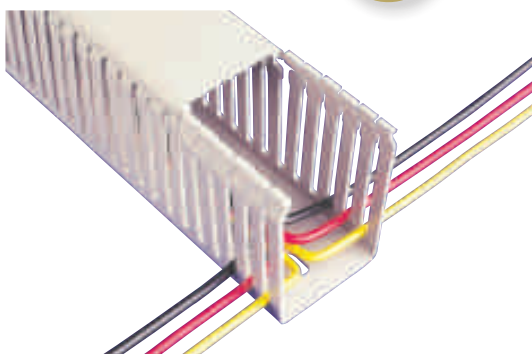

Noryl halogen-free grey narrow slot

Part number	Nominal size inner (WxH) mm	Nominal size outer (WxH) mm	Pack qty (m)
20470021	25 x 25	29 x 29	24
20470022	25 x 37.5	29 x 41	24
20470023	25 x 50	29 x 54	24
20470024	25 x 75	29 x 79	16
20470032	37.5 x 37.5	41 x 41	24
20470033	37.5 x 50	41 x 54	16
20470034	37.5 x 75	39 x 79	16
20470035	37.5 x 100	43 x 105	16
20470053	50 x 50	54 x 54	16
20470054	50 x 75	55 x 79	16
20470055	50 x 100	56 x 105	8
20470073	75 x 50	78 x 54	16
20470074	75 x 75	80 x 80	16
20470075	75 x 100	80 x 105	8
20470103	100 x 50	107 x 54	8
20470104	100 x 75	107 x 80	8
20470105	100 x 100	100 x 100	8
20470124	125 x 75	131 x 78	8

SPECIFICATIONS

Material
Halogen-free Noryl NH5110E

Slot pitch 10mm
Slot width 4mm
Webs 6mm

Colour
Light grey RAL 7035

Service temperature rating
-25°C to +90°C

Oxygen index
35.7% BS EN ISO 4589-2: 1999

Smoke test
BS 6853: 1999 Annex D.8.3 (Small scale smoke emission test)

Flammability UL94 V-1 Rated material

Standards
cULus and UL approved: UL E161178B



Betaduct Noryl halogen-free narrow slot - Blue



Betaduct halogen-free narrow slot is manufactured in the UK from Noryl NH5110E. It provides a lightweight self-extinguishing cable trunking with excellent rigidity and performance characteristics. Ideal for use with slimmer terminal blocks where more access is required, it improves appearance of panels with cables out in best position. For use when bundles, cables and wires need supporting in control panels, distribution boards and switchgear. Suitable for I.S. circuits.

Ideal for use in applications where danger to members of the public is a concern, such as petrochemical plants and offshore oil platforms. Available in 12 sizes. Recommended fixing method; Betaduct rivets or washers. Supplied with lid.

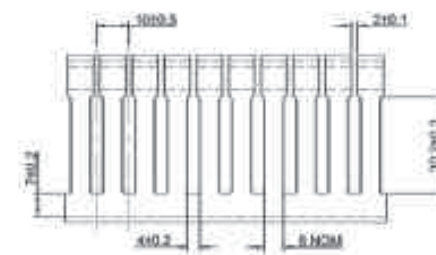

Noryl halogen-free blue narrow slot

Part number	Nominal size inner (WxH) mm	Nominal size outer (WxH) mm	Pack qty (m)
20476023	25 x 50	29 x 54	8
20476024	25 x 75	29 x 79	8
20476033	37.5 x 50	41 x 54	8
20476034	37.5 x 75	39 x 79	8
20476053	50 x 50	54 x 54	8
20476054	50 x 75	55 x 79	8
20476073	75 x 50	78 x 54	8
20476074	75 x 75	80 x 80	8
20476103	100 x 50	107 x 54	4
20476104	100 x 75	107 x 80	4
20476105	100 x 100	107 x 104	4
20476124	125 x 75	131 x 78	4

SPECIFICATIONS

Material
Halogen-free Noryl NH5110E

Slot pitch 10mm
Slot width 4mm
Webs 6mm

Colour
Blue RAL 5015

Service temperature rating
-25°C to +90°C

Oxygen index
35.7% BS EN ISO 4589-2: 1999

Smoke test
BS 6853: 1999 Annex D.8.3 (Small scale smoke emission test)

Flammability UL94 V-1 Rated material

Standards
cULus and UL approved: UL E161178A





Betaduct Noryl halogen-free spare lids



Betaduct halogen-free is manufactured in the UK from Noryl NH5110E. It is made from a material which, during burning, forms a protective charred intumescent surface layer and, being free from halogens, does not emit harmful substances such as hydrochloric acid and chloride gases, which are associated with PVC. Noryl NH5110E provides lightweight cable trunking with excellent rigidity and performance characteristics.

Spare lids are available in grey or blue.



Noryl halogen free spare lids Grey

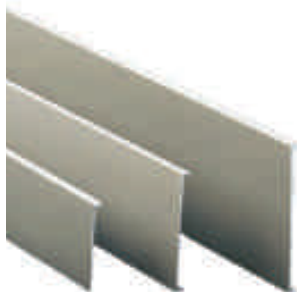

Halogen-free spare lids are made from Noryl NH5110E, a flame retardant, non-halogenated, impact modified extrusion grade polymer.

Part number Grey	Width (mm)	No. of lengths	Pack qty (m)
20450003	37.5	12	24
20450004	50	12	24
20450005	75	12	24
20450006	100	8	16
20450007	125	6	12

Noryl spare lids Blue



Halogen-free spare lids are made from Noryl NH5110E, a flame retardant, non-halogenated, impact modified extrusion grade polymer.

Part number Blue	Width (mm)	No. of lengths	Pack qty (m)
20476003	37.5	4	8
20476004	50	4	8
20476005	75	4	8
20476006	100	2	4
20476007	125	2	4

SPECIFICATIONS

Material Halogen-free Noryl NH5110E

Colour options

Light grey RAL 7035, blue RAL 5015

Service temperature rating -25°C to +90°C

Oxygen index 35.7% BS EN ISO 4589-2: 1999

Smoke test BS 6853: 1999 Annex D.8.3 (Small scale smoke emission test)

Flammability UL94 V-1 Rated material

Standards cULus and UL approved: UL E161178A



Betaduct Noryl Extra halogen-free trunking

Betaduct Noryl Extra is manufactured from high grade NH6010B Noryl, which is a modified polymer manufactured by SABIC Innovative Plastics IPBV.

Noryl is halogen-free and has excellent low smoke characteristics. No other manufacturer extrudes ducting from this grade of Noryl. It is recommended for areas where human life or electronic components are a risk.

Available in open slot, closed slot or solid wall, in a wide range of sizes with 20mm pitching.



Key specifications

- Made from Noryl Extra, a self-extinguishing, halogen-free material: NH6010B
- Service temperature rating of -30°C to +120°C
- Flammability rating: UL94 V-0 Rated material. BS 476 Part 7 Class I (Y)
- Base slots to DIN 43659 & UL



Applications

Noryl Extra is designed and specified for installations in hazardous applications such as rail, underground, marine, mass transit and military applications. It is also widely used in petrochemical plants and offshore oil and gas installations, accommodation modules, rail and mass transit applications.





Betaduct Noryl Extra halogen-free open slot - Black

Betaduct Noryl Extra halogen-free trunking features wide fingers, which give additional cable support and terminated wires can be re-routed easily. For use when bundles, cables and wires need supporting in control panels, distribution boards and switchgear. Designed and specified for installations in hazardous applications such as rail, underground, marine, mass transit and military applications. Widely used in petrochemical plants and offshore oil and gas installations and accommodation modules.



Available in 6 sizes.
Recommended fixing method; Betaduct rivets or washers.
Supplied with lid.

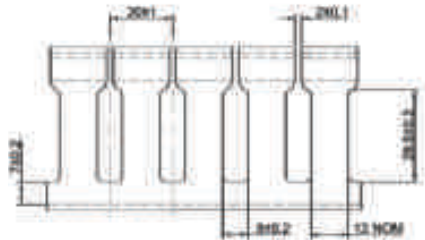

Noryl Extra HF black open slot trunking

Part number	Nominal size inner (WxH) mm	Nominal size outer (WxH) mm	Pack qty (m)
23461000	25 x 37.5	29 x 41	24
23462000	25 x 50	29 x 54	24
23463000	25 x 75	29 x 79	16
23464000	50 x 50	54 x 54	16
23465000	50 x 75	55 x 79	16
23466000	75 x 75	80 x 80	16

SPECIFICATIONS

Material
Self-extinguishing Noryl Extra, halogen-free NH6010B

Slot pitch 20mm
Slot width 8mm
Webs 12mm

Colour
Black RAL 9004

Service temperature rating
-30°C to +120°C

Flammability
UL94 V-0 Rated material. BS 476 Part 7 Class I (Y)

Standards
Base slots to DIN 43659 and UL approved: UL E161178A



Betaduct Noryl Extra halogen-free closed slot - Black

Betaduct Noryl halogen-free trunking provides lightweight self-extinguishing cable trunking with excellent rigidity and performance characteristics. It has excellent cable retention with enhanced protection for installers. For use when bundles, cables and wires need supporting in control panels, distribution boards and switchgear. Designed and specified for installations in hazardous applications such as rail, underground, marine, mass transit and military applications. Widely used in petrochemical plants and offshore oil and gas installations and accommodation modules.



Available in 6 sizes. Recommended fixing method; Betaduct rivets or washers. Supplied with lid.

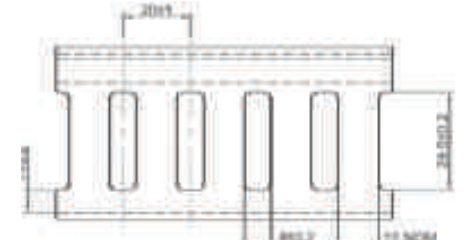

Noryl Extra HF black closed slot trunking

Part number	Nominal size inner (WxH) mm	Nominal size outer (WxH) mm	Pack qty (m)
23451000	25 x 37.5	29 x 41	24
23452000	25 x 50	29 x 54	24
23453000	25 x 75	29 x 79	16
23454000	50 x 50	54 x 54	16
23455000	50 x 75	55 x 79	16
23456000	75 x 75	80 x 80	16

SPECIFICATIONS

Material
Self-extinguishing Noryl Extra, halogen-free NH6010B

Slot pitch 20mm
Slot width 8mm
Webs 12mm

Colour
Black RAL 9004

Service temperature rating
-30°C to +120°C

Flammability
UL94 V-0 Rated material. BS 476 Part 7 Class I (Y)

Standards
Base slots to DIN 43659 and UL approved: UL E161178A





Control panel trunking

Betaduct Noryl Extra halogen-free solid wall - Black

Betaduct Noryl solid wall trunking fully encloses cables providing maximum protection. Ideal for use where little or no breakouts are required when bundles, cables and wires need supporting in control panels, distribution boards and switchgear. Designed and specified for installations in hazardous applications such as rail, underground, marine, mass transit and military applications.

Available in 6 sizes. Recommended fixing method; Betaduct rivets or washers. Supplied with lid.



SPECIFICATIONS

Material
Self-extinguishing Noryl Extra, halogen-free NH6010B

Colour
Black RAL 9004

Service temperature rating
-30°C to +120°C

Flammability
UL94 V-0 Rated material. BS 476 Part 7 Class I (Y)

Standards
Base slots to DIN 43659 and UL approved: UL E161178A

Noryl Extra HF black solid wall trunking

Part number	Nominal size inner (WxH) mm	Nominal size outer (WxH) mm	Pack qty (m)
23471000	25 x 37.5	29 x 41	24
23472000	25 x 50	29 x 54	24
23473000	25 x 75	29 x 79	16
23474000	50 x 50	54 x 54	16
23475000	50 x 75	55 x 79	16
23476000	75 x 75	80 x 80	16

Betaduct Noryl Extra spare lids



SPECIFICATIONS

Material
Self-extinguishing Noryl Extra, halogen-free NH6010B

Colour
Black RAL 9004

Service temperature rating
-30°C to +120°C

Flammability
UL94 V-0 Rated material. BS 476 Part 7 Class I (Y)

Standards
Base slots to DIN 43659 and UL approved: UL E161178A



Noryl Extra HF black spare lids

Part number	Width (mm)	Pack quantity (m)
23481000	25	24
23482000	50	24
23483000	75	24



CABLECRAFT Tool Centre

Tool Calibration & Repair Service

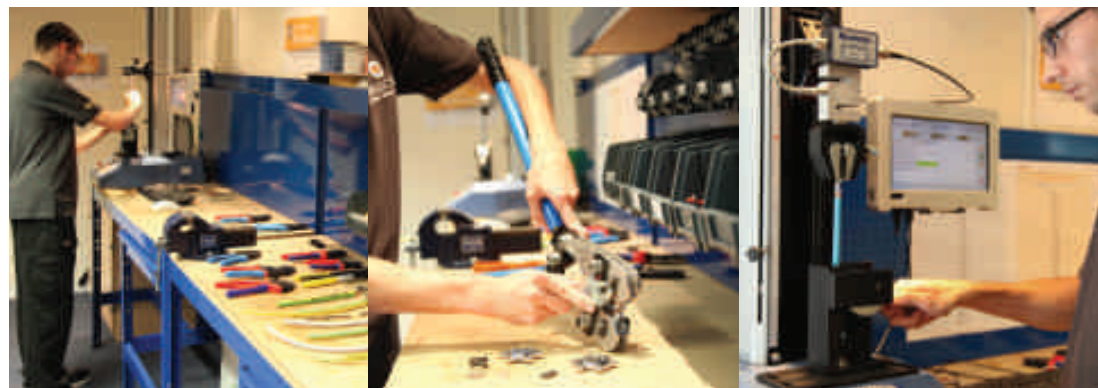

Tool Repair Service



Tool Calibration Service



Our in-house technicians calibrate, repair and inspect not only Cablecraft hand, ratchet and hydraulic tools but also those supplied by most leading manufacturers. We offer a fast, efficient and flexible service including fast turnaround and excellent customer service!

Tools can be calibrated to:

- Electrical Installation Standards BS-EN 60352-2-2006
- Rail Industry Standard RSE STD 024 Part 6

Visit our website for more details www.cablecraft.co.uk





Betaduct tools and accessories

Control panel trunking

Betaduct EDC 1

EDC 1 cutting tool is ideal for cutting trunking fingers up to 50mm. Made from steel and cast iron, with a sharp blade width of 21.5mm.



Part number	Length (mm)	Weight (g)
EDC1	250	455

Betaduct EDC 2

EDC 2 Betaduct trunking cutting tool is made from hardened steel and varnished aluminium. It will cut PVC trunking up to 110mm wide.

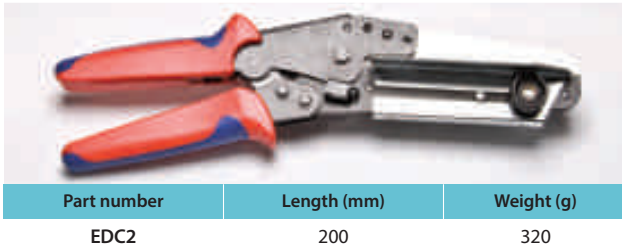

Part number	Length (mm)	Weight (g)
EDC2	200	320

Betaduct EDNT1

EDNT 1 is a side wall notching tool. It features insulated comfort handles for easy operation.

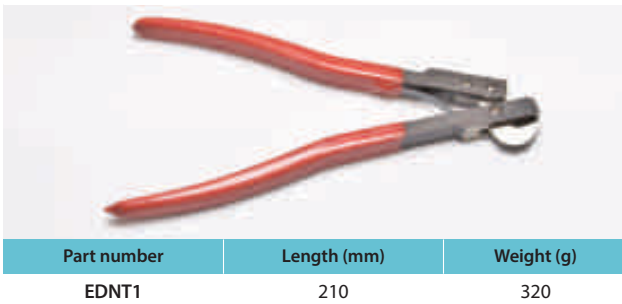

Part number	Length (mm)	Weight (g)
EDNT1	210	320



Betaduct tools and accessories

Control panel trunking

RENN 603 618 3

This Betaduct notching tool is a special tool to cut out side walls of slotted trunking. It has a variable cutting depth of up to 80mm with one cut, and a cutting width of 24mm.



Part number	Length (mm)	Weight (g)
RENN 603 618 3	260	660

Betaduct side cutter

Right angled side cutters for cutting the slots of Betaduct trunking.



Part number	Length (mm)	Weight (g)
18570000	145	140

DC 125 Cutter

The DC 125 cutter cuts trunking at true angles and avoids burring and expensive redressing. Due to the cam mechanism the DC 125 cuts with little effort. The chip free cutting keeps your site clean and free from pollution and noise.

The metre long guide and stop allows cutting of trunking profiles with great accuracy. The blade, in tungsten steel, provides a cutting width of up to 125mm, and is supplied with an integrated guard giving total security. This cutter must be bench mounted.

Part number	Dimensions W x D x L (mm)	Cutting width (mm)	Cutting length (mm)	Weight (Kg)
BETADUCT-CUTTER	1290 x 290 x 760	125	1000 Max	10.5

DC 125 spare blade

Part number	Description
BETADUCT-CUTTER BLADE	Spare blade





Betaduct tools and accessories

Betaduct divider

Betaduct dividers are made from a lightweight self-extinguishing PVC material, with a temperature rating of -15°C to +60°C. Ideal for providing a partition within the cable trunking.

Part no. Grey	Part no. Black	Height (mm)	Pack qty (m)
10450008	10380000	35	8
10450009	10390000	50	8
10450010	10400000	75	8



Betaduct universal divider

The Betaduct universal divider is made from a lightweight self-extinguishing PVC material, with a temperature rating of -15°C to +60°C. This universal partition is ideal for use with a wide range of panel trunking systems.

Part no. Grey	Height (mm)	Pack qty (m)
10450011	60	8



Betaduct label bar

Betaduct PVC label bar is ideal for labelling Betaduct panel trunking in situ. Made from a self-extinguishing PVC with temperature rating -15°C to +65°C.

Part no. Grey	Part no. Black	Width (mm)	Pack qty (m)
ERP-250 LABEL BAR	ERP-250B LABEL BAR	2.5	2



Betaduct tools and accessories

Betaduct rivet tools

Betaduct rivet tool for fixing trunking to the panel. Features an independent sliding metal core for creating the pressure to insert the rivet into the hole. Available in black and green (dependent on size), they fit Betaduct rivets.



Part number	Diameter (mm)	Description	Colour	Pack quantity
RT 6	6.5	To suit rivets: DUCTAFIX R6	Black	1
RT 4	4.5	To suit rivets: DUCTAFIX R4	Green	1

Betaduct rivets

Betaduct nylon rivets for fixing trunking to the panel. Available in black and green (dependent on size), they are equipped with fins for close fitting, allowing quick insertion of the rivet into the tool.



Part number	Diameter (mm)	Dimensions (mm)				Colour	Pack quantity
		A	B	C	D		
DUCTAFIX R6 BLACK	6.5	11	6	2	14	Black	100
DUCTAFIX R4 GREEN	4.5	9	4.5	1.8	12	Green	100

Betaduct insulating washers

Betaduct insulating washers are ideal for all panel building applications. Available in black in packs of 50.



Part number	Colour	Internal Diameter (mm)	Pack quantity
10440000	Black	3.7	50



Betaduct capacity chart

Betaduct capacity chart																	
Trunking size width x height (mm)	Cross sectional area (mm ²)	At 55% packing density (mm ²)	CABLE CROSS SECTIONAL AREA (mm ²) TRI-RATED CABLE BS5231														
			CABLE DIAMETER (mm)														
			0.50	0.75	1.00	1.50	2.50	4.00	6.00	10.00	16.00	25.00	35.00	50.00	70.00	95.00	
MAXIMUM NUMBER OF CABLES																	
15 x 15	225	123.75	21	18	16	13	10	8	6	3	2	1	-	-	-	-	-
19 x 50	950	522.5	91	79	69	57	46	34	25	14	8	6	5	3	2	1	1
25 x 20	500	275	48	41	36	30	24	18	13	7	4	3	2	1	1	1	1
25 x 37.5	937.5	515.6	90	78	68	56	45	33	25	14	8	6	4	3	2	1	1
25 x 50	1250	687.5	120	104	91	75	60	45	33	18	11	8	6	4	3	2	2
25 x 75	1875	1031.25	180	156	136	113	90	67	50	28	17	12	9	6	4	3	3
25 x 100	2500	1375	240	208	182	151	121	90	67	37	23	16	13	8	6	5	5
37.5 x 37.5	1406	773.3	135	117	102	85	68	50	37	21	13	9	7	5	3	2	2
37.5 x 50	1875	1031.25	180	156	136	113	90	67	50	28	17	12	9	6	4	3	3
37.5 x 75	2813	1547.15	270	234	204	170	136	101	75	42	26	19	14	10	7	5	7
37.5 x 100	3750	2062.5	360	312	273	227	181	135	100	56	35	25	19	13	9	7	9
50 x 25	1250	687.5	120	104	91	75	60	45	33	18	11	8	6	4	3	2	2
50 x 37.5	1875	1031.25	180	156	136	113	90	67	50	28	17	12	9	6	4	3	3
50 x 50	2500	1375	240	208	182	151	121	90	67	37	23	16	13	8	6	5	5
50 x 75	3750	2062.5	360	312	273	227	181	135	100	56	35	25	19	13	9	7	9
50 x 100	5000	2750	480	416	364	303	242	180	134	75	46	33	26	17	12	10	10
75 x 37.5	2813	1547.15	270	234	204	170	136	101	75	42	26	19	14	10	7	5	7
75 x 50	3750	2062.5	360	312	273	227	181	135	100	56	35	25	19	13	9	7	9
75 x 75	5625	3093.75	540	468	409	346	285	224	163	85	52	38	29	20	14	11	11
75 x 100	7500	4125	720	624	546	464	393	321	251	113	70	50	39	26	19	15	15
100 x 50	5000	2750	480	416	364	303	242	180	134	75	46	33	26	17	12	10	10
100 x 75	7500	4125	720	624	546	464	393	321	251	113	70	50	39	26	19	15	15
100 x 100	10000	5500	960	832	728	605	484	361	269	151	93	67	53	35	25	20	20
100 x 125	12500	6875	1200	1040	910	757	606	452	336	189	117	84	66	44	32	25	25
125 x 75	9375	5156.25	900	780	683	567	454	339	252	141	87	63	49	33	24	19	19

Betaduct for the rail industry

Betaduct slotted panel trunking is designed for installations in hazardous applications such as rail and the underground. Betaduct is approved and specified by Network Rail. Below you will find a reference chart to help find your required Rail PADS number.

Rail PADS number reference chart				
Rail pads number	Betaduct Part number	Dimensions W x H (mm)	Betaduct type	Betaduct material
PVC GREY RAIL 7030				
054 073272	10450022	25 x 37.5	Open slot	PVC grey rail 7030
054 073275	10450051	50 x 25	Open slot	PVC grey rail 7030
054 073273	10450053	50 x 50	Open slot	PVC grey rail 7030
054 160007	10460022	25 x 37.5	Closed slot	PVC grey rail 7030
054 073289	10460023	25 x 50	Closed slot	PVC grey rail 7030
054 073295	10460024	25 x 75	Closed slot	PVC grey rail 7030
054 073296	10460053	50 x 50	Closed slot	PVC grey rail 7030
054 073297	10460054	50 x 75	Closed slot	PVC grey rail 7030
054 073298	10460074	75 x 75	Closed slot	PVC grey rail 7030
054 073281	10480011	15 x 15	Solid wall	PVC grey rail 7030
054 020253	10480022	25 x 37.5	Solid wall	PVC grey rail 7030
054 073274	10480023	25 x 50	Solid wall	PVC grey rail 7030
054 073299	10480024	25 x 75	Solid wall	PVC grey rail 7030
054 073301	10480053	50 x 50	Solid wall	PVC grey rail 7030
054 073302	10480054	50 x 75	Solid wall	PVC grey rail 7030
054 073303	10480074	75 x 75	Solid wall	PVC grey rail 7030
PVC BLACK RAIL 9005				
054 160010	09810000	25 x 37.5	Open slot	PVC black rail 9005
054 160018	09130000	25 x 50	Open slot	PVC black rail 9005
054 160025	09160000	50 x 50	Open slot	PVC black rail 9005
054 160034	09170000	50 x 75	Open slot	PVC black rail 9005
054 160038	09190000	75 x 75	Open slot	PVC black rail 9005
054 160048	09000000	15 x 15	Closed slot	PVC black rail 9005
054 160008	09510000	25 x 37.5	Closed slot	PVC black rail 9005
054 160019	09030000	25 x 50	Closed slot	PVC black rail 9005
054 073059	09040000	25 x 75	Closed slot	PVC black rail 9005
054 073279	09380000	50 x 25	Closed slot	PVC black rail 9005
054 160026	09060000	50 x 50	Closed slot	PVC black rail 9005
054 160035	09070000	50 x 75	Closed slot	PVC black rail 9005
054 160033	09090000	75 x 75	Closed slot	PVC black rail 9005
054 073320	09400000	125 x 75	Closed slot	PVC black rail 9005



Betaduct for the rail industry continued

Control panel trunking

Rail PADS number reference chart <small>continued</small>				
Rail pads number	Betaduct Part number	Dimensions W x H (mm)	Betaduct type	Betaduct material
PVC BLACK RAIL 9005				
054 160049	09200000	15 x 15	Solid wall	PVC black rail 9005
054 160012	10110000	25 x 37.5	Solid wall	PVC black rail 9005
054 160016	09230000	25 x 50	Solid wall	PVC black rail 9005
054 160027	09260000	50 x 50	Solid wall	PVC black rail 9005
054 160036	09270000	50 x 75	Solid wall	PVC black rail 9005
054 160039	09290000	75 x 75	Solid wall	PVC black rail 9005
054 073319	09420000	125 x 75	Solid wall	PVC black rail 9005
054 160051	10380000	37.5	Divider	PVC black rail 9005
054 160052	10390000	50	Divider	PVC black rail 9005
054 160053	10400000	75	Divider	PVC black rail 9005
NORYL BLACK RAIL 9004				
054 073322	23462000	25 x 50	Open slot	Noryl black rail 9004
015 072845	23463000	25 x 75	Open slot	Noryl black rail 9004
054 073324	23464000	50 X 50	Open slot	Noryl black rail 9004
054 073325	23465000	50 X 75	Open slot	Noryl black rail 9004
054 073312	23452000	25 x 50	Closed slot	Noryl black rail 9004
054 073314	23454000	50 x 50	Closed slot	Noryl black rail 9004
054 073315	23455000	50 x 75	Closed slot	Noryl black rail 9004
054 073316	23456000	75 x 75	Closed slot	Noryl black rail 9004
054 073332	23472000	25 x 50	Solid wall	Noryl black rail 9004
054 073334	23474000	50 x 50	Solid wall	Noryl black rail 9004
054 073336	23476000	75 x 75	Solid wall	Noryl black rail 9004



IMAGE © TRANSPORT FOR LONDON 2005

Betaduct PVC metric trunking and accessories



Betaduct PVC metric open slot provides lightweight self-extinguishing cable trunking with excellent rigidity and performance characteristics. A smooth wire entry allows for quick and easy re-routing of wires.

A double scoreline allows easy removal of wall section or individual fingers by hand, without the use of tools. Recommended fixing method – Betaduct rivets.

Available in 8mm open slot and 4mm narrow open slot.



Control panel trunking



Key specifications

Material
Made from self-extinguishing rigid PVC

Service temperature rating
-15°C to +60°C

Flammability rating
UL94 V-0 rated material

Tensile strength
To yield point 46.2 MPa,
Ultimate 37.3 MPa

Elongation
To yield point 25%

Standards
RoHS 2 compliant, UL94 V-0,
A Norme EN50085-2-3, CSA,
UR, RINA, CE marked

How our metric trunking is tested

Our metric trunking is subjected to rigorous testing methods to ensure product functionality, reliability and customer satisfaction.

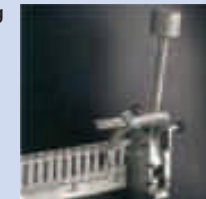

Finger and side segment removal test

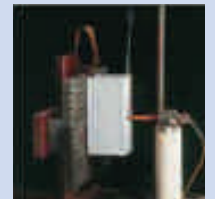

Testing heat resistance



Shock testing at low temperature

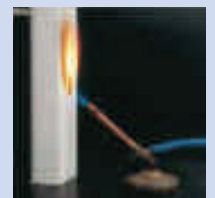

Flame propagation resistance test



Betaduct PVC metric open slot trunking

Betaduct PVC metric 8mm open slot - Grey

Betaduct PVC metric open slot provides lightweight self-extinguishing cable trunking with excellent rigidity and performance characteristics. A smooth wire entry allows for quick and easy re-routing of wires.

Recommended fixing method – Betaduct rivets. Supplied with lid. Available in 34 sizes.

Product features

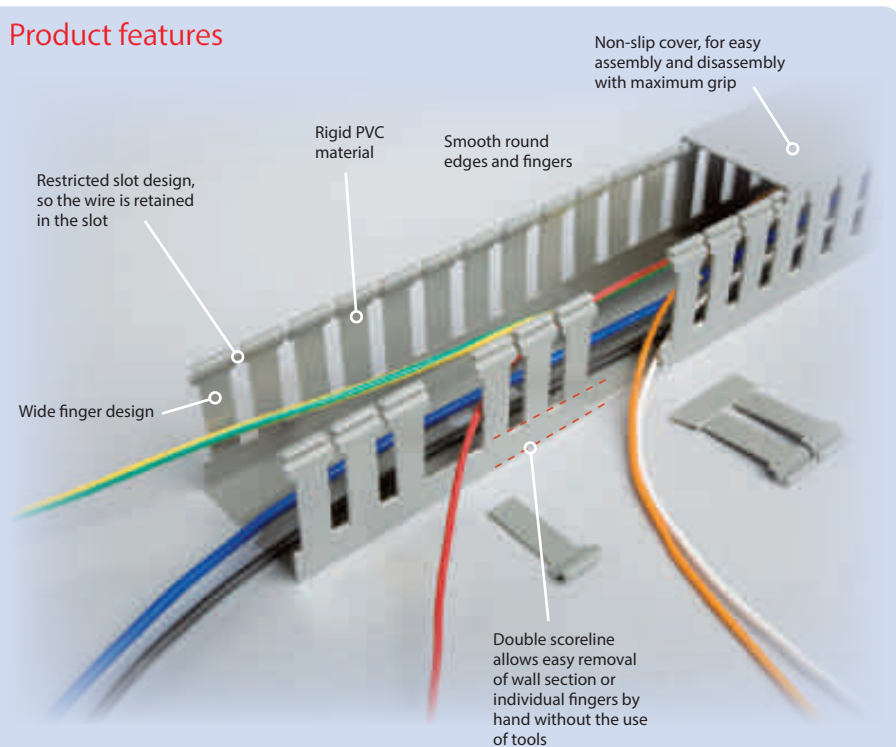

Feature	Benefit
Rigid PVC material	Self-extinguishing PVC, RAL 7030, UL94 V-0.
Double scoreline	Allows easy removal of wall section or individual fingers by hand without the use of tools.
Non-slip cover	For easy assembly and disassembly with maximum grip.
Smooth edges and fingers	Will not cause injury or damage wires and cables.
Smooth wire entry	Allows for quick insertion of wires.



SPECIFICATIONS

Material Self-extinguishing PVC

Slot pitch 20mm, **Slot width** 8mm, **Webs** 12mm

Colour Grey RAL 7030

Service temperature rating -15°C to +60°C

Flammability UL94 V-0 Rated material

Standards RoHS 2 compliant, UL94 V-0, A Norme EN50085-2-3, CSA, UR, RINA, CE marked

SIDE SLOT DESIGN

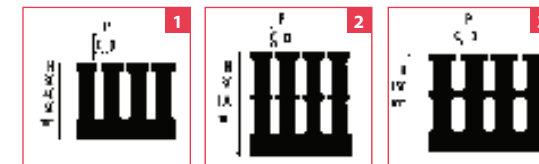

BASE HOLE DESIGN

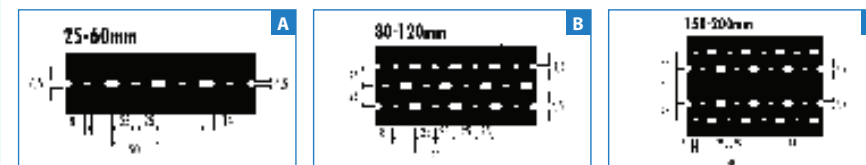

Betaduct PVC metric 8mm open slot

Part number	External size WxH (mm)	Usable section (mm ²)	Base hole design	Side slot design	Dimensions (mm)			Pack quantity (m)
					C	D	P	
10430021	25 x 30	550	A	1	8	12	20	80
10430022	25 x 40	760		1	8	12	20	60
10430023	25 x 60	1200		1	8	12	20	40
10430024	25 x 80	1540		2	8	12	20	32
10430025	25 x 100	2310		2	8	12	20	24
10430031	40 x 30	920	A	1	8	12	20	48
10430032	40 x 40	1310		1	8	12	20	40
10430033	40 x 60	1960		1	8	12	20	36
10430034	40 x 80	2680		2	8	12	20	24
10430045	40 x 100	3350		2	8	12	20	16
10430061	60 x 30	1400	A	1	8	12	20	32
10430062	60 x 40	1960		1	8	12	20	24
10430063	60 x 60	3080		1	8	12	20	24
10430064	60 x 80	4200		2	8	12	20	24
10430065	60 x 100	5320		2	8	12	20	16

CONTINUED OVERLEAF >



Betaduct PVC metric 8mm open slot - Grey *continued*

Control panel trunking



SIDE SLOT DESIGN Double restricted slot design on some sizes

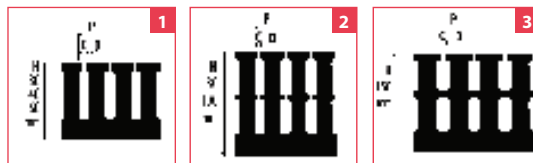

BASE HOLE DESIGN

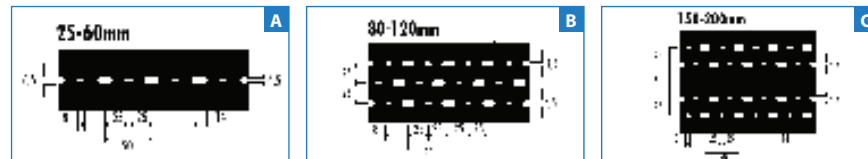

Betaduct PVC 8mm open slot								
Part number	Size WxH (mm)	Usable section (mm ²)	Base hole design	Side slot design	Dimensions (mm)			Pack quantity (m)
					C	D	P	
10430082	80 x 40	2655	B	1	8	12	20	24
10430083	80 x 60	4175		1	8	12	20	24
10430084	80 x 80	5695		2	8	12	20	24
10430085	80 x 100	7125		2	8	12	20	16
10430102	100 x 40	3375	B	1	8	12	20	16
10430103	100 x 60	5295		1	8	12	20	20
10430104	100 x 80	7215		1	8	12	20	16
10430105	100 x 100	9135		2	8	12	20	16
10430107	100 x 150	13695	C	3	20	30	50	8
10430122	120 x 40	4070		1	8	12	20	20
10430123	120 x 60	6390		1	8	12	20	16
10430124	120 x 80	8710		2	8	12	20	16
10430125	120 x 100	10820	C	2	8	12	20	8
10430126	150 x 60	8070		1	8	12	20	12
10430127	150 x 80	10770		2	8	12	20	12
10430128	150 x 100	13670		2	8	12	20	8
10430129	200 x 60	10820	C	1	8	12	20	8
10430130	200 x 80	14470		2	8	12	20	8
10430131	200 x 100	18370		2	8	12	20	8

Betaduct PVC metric narrow open slot trunking

Betaduct PVC metric narrow open slot provides lightweight self-extinguishing cable trunking with excellent rigidity and performance characteristics. A smooth wire entry allows for quick and easy re-routing of wires.

Recommended fixing method – Betaduct rivets. Supplied with lid. Available in 25 sizes.

Control panel trunking

Product features

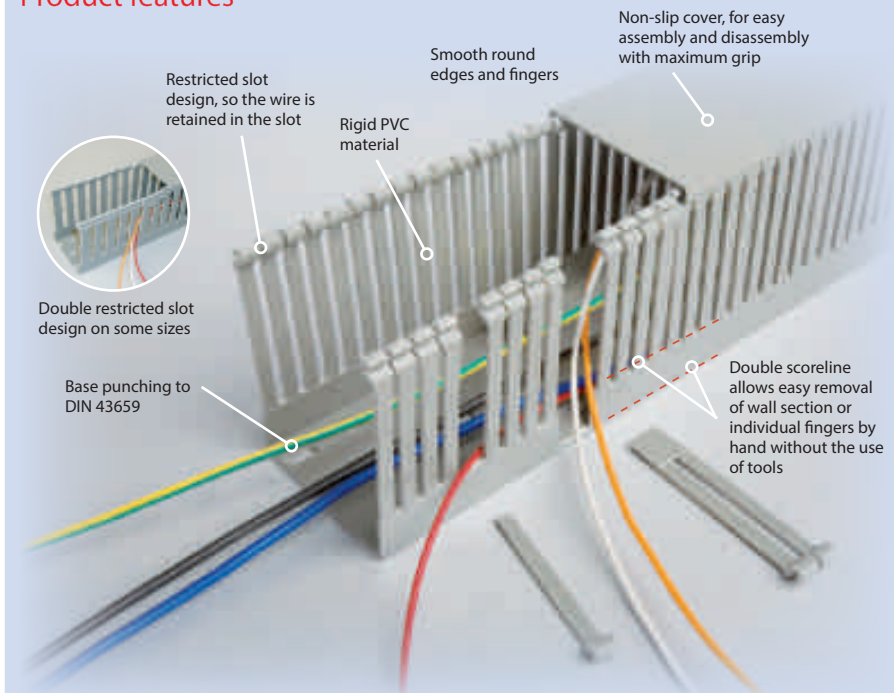

Feature	Benefit
Rigid PVC material	Self-extinguishing PVC, RAL 7030, UL94 V-0.
Double scoreline	Allows easy removal of wall section or individual fingers by hand without the use of tools.
Non-slip cover	For easy assembly and disassembly with maximum grip.
Smooth edges and fingers	Will not cause injury or damage wires and cables.
Smooth wire entry	Allows for quick insertion of wires.
Restricted slot design	To retain the wire securely in the slot. Some sizes have a double restricted slot design. See table overleaf for details.



Betaduct PVC metric narrow 4mm open slot - Grey

Betaduct PVC metric narrow open slot provides lightweight self-extinguishing cable trunking with excellent rigidity and performance characteristics. A smooth wire entry allows for quick and easy re-routing of wires.

Recommended fixing method – Betaduct rivets. Supplied with lid. Available in 25 sizes.

SPECIFICATIONS

- Material**
Self-extinguishing PVC
- Slot pitch** 10mm
- Slot width** 4mm
- Webs** 6mm
- Colour**
Grey RAL 7030
- Service temperature rating**
-15°C to +60°C
- Flammability**
UL94 V-0 Rated material
- Standards**
RoHS 2 compliant,
UL94 V-0, A Norme
EN50085-2-3, CSA, UR, RINA, CE
marked.



SIDE SLOT DESIGN

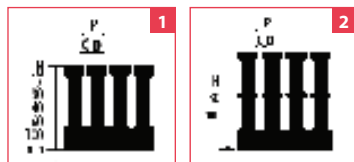

Double restricted slot design on some sizes.

Betaduct PVC 4mm narrow open slot

Part number	External size WxH (mm)	Usable section (mm ²)	Base hole design	Side slot design	Dimensions (mm)			Pack quantity (m)
					C	D	P	
10440011	15 x 17	170		1	4	6	10	120
10440012	15 x 30	320	A	1	4	6	10	96
10440013	15 x 40	450		1	4	6	10	72
10440021	25 x 30	550		1	4	6	10	80
10440022	25 x 40	760		1	4	6	10	60
10440023	25 x 60	1200	B	1	4	6	10	40
10440024	25 x 80	1540		2	4	6	10	32
10440025	25 x 100	2310		1	4	6	10	24
10440032	40 x 40	1310		1	4	6	10	40
10440033	40 x 60	1960		1	4	6	10	36
10440034	40 x 80	2680	B	2	4	6	10	24
10440045	40 x 100	3350		1	4	6	10	16



BASE HOLE DESIGN

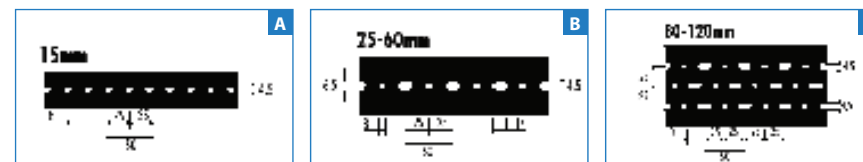

Betaduct PVC metric 4mm narrow open slot

Part number	External size WxH (mm)	Usable section (mm ²)	Base hole design	Side slot design	Dimensions (mm)			Pack quantity (m)
					C	D	P	
10440062	60 x 40	1960		1	4	6	10	24
10440063	60 x 60	3080		1	4	6	10	24
10440064	60 x 80	4200	B	2	4	6	10	24
10440065	60 x 100	5320		1	4	6	10	16
10440082	80 x 40	2655		1	4	6	10	24
10440083	80 x 60	4175		1	4	6	10	24
10440084	80 x 80	5695	C	2	4	6	10	24
10440085	80 x 100	7125		1	4	6	10	16
10440103	100 x 60	5295		1	4	6	10	20
10440104	100 x 80	7215		2	4	6	10	16
10440105	100 x 100	9135	C	1	4	6	10	16
10440123	120 x 60	6390		1	4	6	10	16
10440124	120 x 80	8710		2	4	6	10	16



Betaduct metric accessories

Betaduct metric rivets

Betaduct metric nylon rivets for fixing trunking to the panel. Available in black and green (dependent on size), they are equipped with fins for close fitting, allowing quick insertion of the rivet into the tool.



Part number	Diameter (mm)	Dimensions (mm)				Colour	Pack quantity
		A	B	C	D		
DUCTAFIX R6 BLACK	6.5	11	6	2	14	Black	100
DUCTAFIX R4 GREEN	4.5	9	4.5	1.8	12	Green	100

Betaduct metric rivet tool

Betaduct metric rivet tool for fixing trunking to the panel. Features an independent sliding metal core for creating the pressure to insert the rivet into the hole. Available in black and green (dependent on size), they fit Betaduct rivets.



Part number	Diameter (mm)	Description	Colour	Pack quantity
RT 6	6.5	To suit rivets: DUCTAFIX R6	Black	1
RT 4	4.5	To suit rivets: DUCTAFIX R4	Green	1

Betaduct metric accessories continued

Betaduct metric spare lids

Betaduct metric self-extinguishing lids are non-slip, for easy assembly and disassembly with maximum grip. Made from PVC material and available in Grey RAL 7030. Fits all Betaduct metric trunking. RoHS 2 compliant.



Part number	Width	Pack quantity (m)
10440001	15	24
10440002	25	24
10440003	40	24
10440004	60	24
10440005	80	24
10440006	100	16
10440007	120	12
10440008	150	12
10440009	200	12

DC 125 Cutter

The DC 125 cutter cuts trunking at true angles and avoids burring and expensive redressing. Due to the cam mechanism the DC 125 cuts with little effort. The chip free cutting keeps your site clean and free from pollution and noise.

The metre long guide and stop allows cutting of trunking profiles with great accuracy. The blade, in tungsten steel, provides a cutting width of up to 125mm, and is supplied with an integrated guard giving total security. This cutter must be bench mounted.

Part number	Dimensions W x D x L (mm)	Cutting width (mm)	Cutting length (mm)	Weight (Kg)
BETADUCT-CUTTER	1290 x 290 x 760	125	1000 Max	10.5

DC 125 spare blade

Part number	Description
BETADUCT-CUTTER BLADE	Spare blade





Betaduct metric capacity chart

Control panel trunking

Betaduct metric capacity chart													
External trunking size Width x Height (mm)	Usable cross sectional area (mm ²)	CABLE AWG											
		8	10	12	14		16		18		22		
		CABLE CROSS SECTIONAL AREA(mm ²)											
		0.216	0.153	0.122	0.158	0.105	0.139	0.165	0.096	0.125	0.084	0.113	0.065
		CABLE TYPE											
THHN	THHN	THHN	MTW	THHN	MTW	MTW	TFFN	MTW	TFFN	MTW	MTW		
MAXIMUM NUMBER OF CABLES													
15 x 17	170	4	7	10	7	14	10	6	18	11	24	13	40
15 x 30	320	7	12	20	14	27	18	12	34	20	45	25	75
25 x 30	550	12	21	34	24	46	31	20	59	35	77	43	129
40 x 30	920	20	35	56	40	76	52	33	98	58	129	71	215
60 x 30	1400	31	54	85	60	116	79	51	150	88	197	108	328
15 x 40	450	10	17	27	19	37	26	16	48	28	63	35	105
25 x 40	760	17	29	46	33	63	43	28	81	48	107	59	178
40 x 40	1310	29	50	80	57	109	74	48	140	83	184	101	306
60 x 40	1960	43	75	120	85	163	111	71	210	124	275	152	459
80 x 40	2655	58	102	162	115	220	151	96	284	168	373	205	621
100 x 40	3375	74	130	206	146	280	192	122	361	213	474	261	790
120 x 40	4070	89	156	248	176	338	231	148	435	257	571	315	952
25 x 60	1200	26	46	73	52	100	68	44	128	76	168	93	281
40 x 60	1960	43	75	120	85	163	111	71	210	124	275	152	459
60 x 60	3080	68	118	188	133	256	175	112	330	194	432	238	721
80 x 60	4175	92	161	255	180	347	237	151	447	264	586	323	977
100 x 60	5295	116	204	323	229	440	301	192	566	334	743	409	1239
120 x 60	6390	140	246	390	276	530	363	232	684	403	897	494	1495
150 x 60	8070	177	310	493	349	670	458	293	863	510	1133	624	1888
200 x 60	10820	237	416	661	467	898	614	393	1158	683	1519	837	2531

Betaduct metric capacity chart continued													
External trunking size Width x Height (mm)	Usable cross sectional area (mm ²)	CABLE AWG											
		8	10	12	14		16		18		22		
		CABLE CROSS SECTIONAL AREA(mm ²)											
		0.216	0.153	0.122	0.158	0.105	0.139	0.165	0.096	0.125	0.084	0.113	0.065
		CABLE TYPE											
THHN	THHN	THHN	MTW	THHN	MTW	MTW	TFFN	MTW	TFFN	MTW	MTW		
MAXIMUM NUMBER OF CABLES													
25 x 80	1540	34	59	94	67	128	87	56	165	97	216	119	360
40 x 80	2680	59	103	164	116	222	152	97	287	169	376	207	627
60 x 80	4200	92	161	256	181	349	238	152	449	265	590	325	983
80 x 80	5695	125	219	348	246	473	323	207	609	360	800	440	1332
100 x 80	7215	158	277	440	312	599	409	262	772	456	1013	558	1688
120 x 80	8710	191	335	532	376	723	494	316	932	550	1223	674	2038
150 x 80	10770	236	414	658	465	894	611	391	1152	680	1512	833	2520
200 x 80	14470	317	556	883	625	1201	821	525	1548	914	2031	1119	3385
25 x 100	2310	51	89	141	100	192	131	84	247	146	324	179	540
40 x 100	3350	73	129	205	145	278	190	122	358	212	470	259	784
60 x 100	5320	117	205	325	230	442	302	193	569	336	747	411	1245
80 x 100	7125	156	274	435	308	591	404	258	762	450	1000	551	1667
100 x 100	9135	200	351	558	395	758	518	331	977	577	1282	706	2137
120 x 100	10820	237	416	661	467	898	614	393	1158	683	1519	837	2531
150 x 100	13670	300	526	835	590	1135	776	496	1462	863	1919	1057	3198
200 x 100	18370	403	706	1122	794	1525	1043	666	1965	1160	2579	1421	4298
100 x 150	13695	300	527	836	592	1137	777	497	1465	865	1923	1059	3204

Control panel trunking