

WARNING

DO NOT INSTALL THE ACTUAL SMOKE ALARM IN NEW OR RENOVATED BUILDINGS UNTIL ALL WORK IS COMPLETED (INCLUDING FLOOR COVERINGS) AND BUILDING HAS BEEN FULLY CLEANED.

(Excessive dust & debris from building work can contaminate the smoke chamber and cause problems).

An installed smoke alarm must be removed or covered fully (with a plastic bag or similar) before renovations begin.

P/N B10274 Rev6

© Ei Electronics 2013



OPTICAL SMOKE ALARM



Models:

Ei105B

**Ei105C
WITH INTERCONNECT**

Contains vital information on unit operation and installation. Read and retain carefully. If you are just installing this unit this leaflet **MUST** be given to the householder.

Please read the first short section containing basic information.

Basic Information about your Smoke Alarm

A Smoke Alarm is an early warning device. Used correctly it can give you and your family valuable extra time to escape.

Note:-

- When the battery is first connected the Alarm may sound for 2-3 seconds and/or the LED may flash quickly for 10 seconds - **this is normal.**
- A Smoke Alarm does not prevent fires.
- Install correctly, in the centre of the ceiling if possible.
- Test monthly.
- When the Alarm beeps **and** LED flashes at the same time replace battery.
- If the Alarm beeps **without** the LED flashing at the same time then clean unit as this is the automatic test feature telling you the chamber is degraded.
- Plan your escape route.
- Proper protection may require more than one Smoke Alarm.
- If you have any doubt or query about Smoke Alarms consult the supplier or your local Fire Brigade.

Locating your Smoke Alarm

Sufficient smoke must enter your Smoke Alarm before it will respond. Your Smoke Alarm needs to be within 10 paces (23 feet) of the fire to respond quickly. It also needs to be in a position where its alarm can be heard throughout your home, so it can wake you and your family in time for you all to escape. A **single** Smoke Alarm will give some protection if it is properly installed, but most homes will require **two** or more to ensure that a reliable early warning is given. For maximum protection you should put individual Smoke Alarms in all the rooms where fire is most likely to break out.

Your first Smoke Alarm should be located between the sleeping area and the most likely sources of fire (living room or kitchen for example). But it should not be more than 10 paces (seven metres) from the door to any room where a fire might start and block your escape from the house.

(a) Single Storey Dwelling

If your Home is on one level (a bungalow or mobile home for example) you should put your first Smoke Alarm in a corridor or hallway between the sleeping and living areas. Place it as near to the living area as possible, but make sure you can hear it loudly enough to wake you in the bedroom. (for example, see figure 1).

If your bungalow is very large and the corridor or hallway is more than say 22 paces (15 metres) long, one Smoke Alarm will not be sufficient. This is because no matter where it is located it will be more than 7.5 metres from potential fires.

Recommended protection, Figures 1,2 & 3

- Minimum protection
 - each storey
 - each sleeping area.
 - every 7.5 metres (25 ft) of hallways and rooms.
- Maximum protection.
All rooms (except bathroom & kitchens)

Figure 1: Single Storey Dwelling

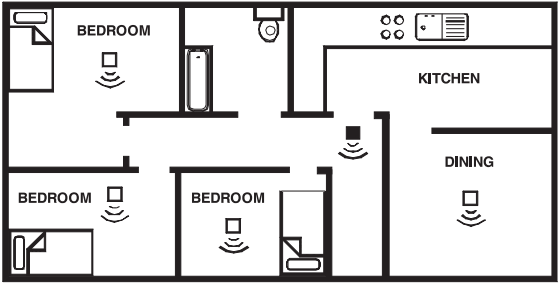

Figure 2: Single Storey Dwelling with separate sleeping areas

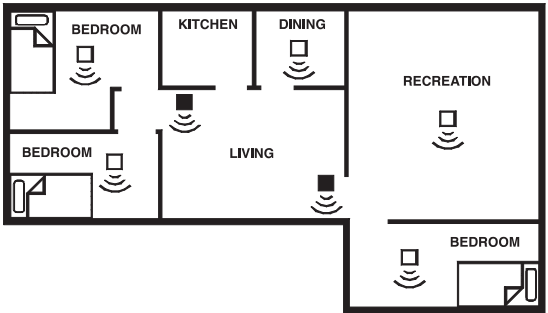
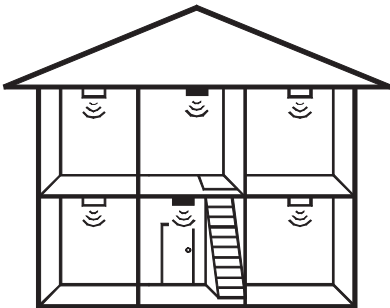

Figure 3: Multi Storey Dwelling



In houses with more than one sleeping area, Smoke Alarms should be placed between each sleeping area and the living area (for example, see figure 2).

(b) Multi Storey Dwellings

If your home is on more than one level the best place for your first Smoke Alarm is in the downstairs hallway near the stairs (for example see figure 3). This is because smoke is likely to be detectable in the hallway before it reaches the upstairs landing and bedrooms. Your second Smoke Alarm should be upstairs, because the downstairs Smoke Alarm is unlikely to detect the smoke from a fire in a bedroom upstairs.

(c) Maximum Protection

For maximum protection you should put individual Smoke Alarms in all the rooms where fire is most likely to break out (apart from the locations to avoid, mentioned below). The living room is the most likely place for a fire to start at night, followed by the kitchen and then the dining room. You should also consider putting Smoke Alarms in any bedrooms where fires might occur, for instance, where there is an electrical appliance such as an electric blanket or heater, or where the occupant is a smoker. You could also consider putting Smoke Alarms in any rooms where the occupant is unable to respond very well to a fire starting in the room, such as an elderly or sick person or a very young child.

(d) Checking you can hear your Smoke Alarm

With the Smoke Alarm sounding in its intended location, check you are able to hear it in each bedroom with the door closed, above the sound of your radio. The radio should be set to a reasonably loud conversation level. If you can't hear it over your radio the chances are that it wouldn't wake you.

If a Smoke Alarm is too far away for it to wake you, it is best to link it to another Smoke Alarm near the bedroom. The Interconnect Smoke Alarms Ei105C and Ei100C are designed for this - when one alarm senses smoke, all connected alarms respond.

Positioning your Smoke Alarm

(a) Ceiling Mounting

Hot smoke rises and spreads out, so a central ceiling position is the preferred location. The air is "dead" and does not move in corners, therefore Smoke Alarms must be mounted away from corners. Place the unit at least 30cm (12 inches) from any light fitting or decorative object which might obstruct smoke entering the Smoke Alarm. Keep at least 15 cm (6 inches) away from walls and corners. See figure 4.

(b) Wall Mounting

When a ceiling position is not practical (for example on a ceiling having exposed beams or joists, or built-in radiant heating) put the top edge of your Smoke Alarm between 15 and 30 cm (6 and 12 inches) below the ceiling. Keep at least 15cm (6 inches) from corners. (see figure 4).

Figure 4

IDEAL IN CENTRE
OF CEILING

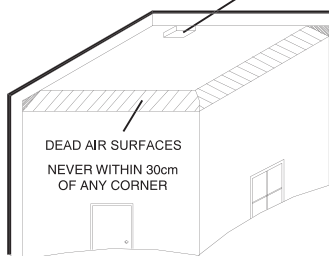
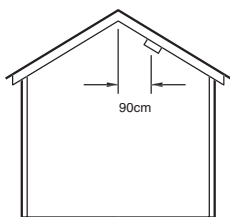

Figure 5



(c) On a sloping Ceiling

In areas with sloping or peaked ceilings install your Smoke Alarm 90 cm (3 feet) from the highest point measured horizontally (see figure 5), because “dead air” at the apex may prevent smoke from reaching the unit.

(d) Locations to Avoid

Don't place your Smoke Alarm in any of the following areas:

- **Bathrooms, shower rooms, garages** or other rooms where the smoke alarm may be triggered by steam, condensation, normal smoke or fumes.
- **Attics** or other places where extremes of temperature may occur (below 4°C/34°F or above 40°C/104°F).
- Near a **decorative object, door, light fitting, window molding** etc., that may prevent smoke from entering the Smoke Alarm.
- Surfaces that are normally **warmer** or **colder** than the rest of the room (for example attic hatches, uninsulated exterior walls etc). Temperature differences might stop smoke from reaching the unit.
- Next to or directly above **heaters** or **air conditioning vents, windows, wall vents** etc. that can change the direction of airflow.
- In very high or **awkward areas** where it may be difficult to reach the alarm (for testing, battery replacement etc).
- Locate unit at least 1.5m (5 feet) and route wiring at least 1m (3 feet) away from **fluorescent light fittings** as electrical “noise” and/or flickering may affect the unit.
- Locate away from very **dusty** or **dirty areas** as dust build-up in the chamber can make unit too sensitive and prone to alarm. It can also block the insect screen mesh and prevent smoke from entering the chamber.
- Do not locate in **insect infested areas**. Small insects getting in to the chamber can cause intermittent alarms.

(e) Nuisance/False Alarms

If, when the alarm goes off, there is no sign of smoke heat or noise to indicate that there is a fire, you should get your family into a safe place, before you start investigating.

Check the house carefully in case there is a small fire smouldering somewhere.

Check whether there is some source of smoke or fumes, for example cooking fumes being drawn past the Smoke Alarm by an extractor.

If there are frequent nuisance/false alarms it may be necessary to re-locate the device away from the source of the fumes. Fanning vigorously with a newspaper or similar will help silence alarm.

Installing your Smoke Alarm

(a) Attaching to Ceiling or Wall

(NB: For Interconnecting see page 9)

Figure 6

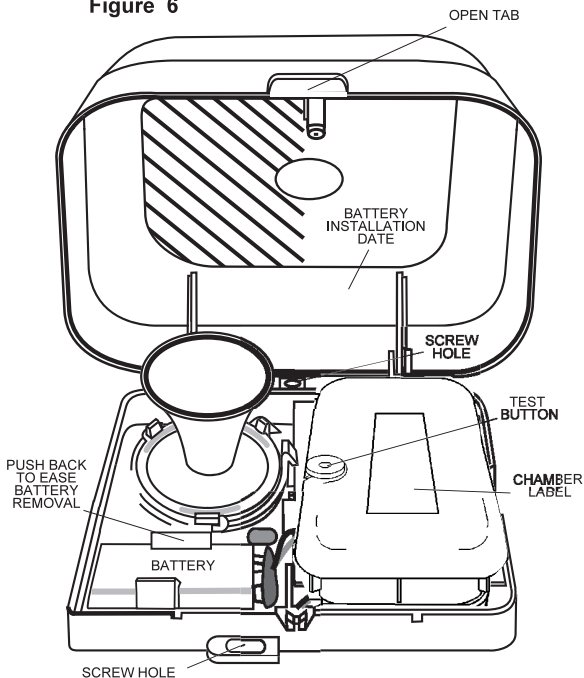

The Smoke Alarm is battery operated and needs only wiring, if the Inter-Link facility is being used.

1. Pull cover open at tab. Remove cover from base by separating at rear snap-in hinges by rotating cover backwards.
2. Place the base on ceiling or wall exactly where you want to mount the unit. With a pencil, mark the location of the screw holes.
3. Taking care to avoid any electrical wiring in the ceiling or wall, drill a hole through the centres of the marked locations. Push the plastic Screw Anchors provided into the drilled holes. Screw in firmly.

(b) Connecting the battery

The battery is easily removed from the holder by holding back one of the plastic clips while lifting the battery with the other hand.

Snap Battery Connectors to Battery. They fit together only one way.

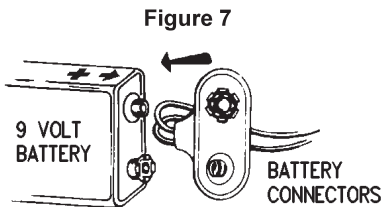

Gently push Battery into Battery Holder

With a pencil, write the date of battery installation on the inside of the cover to remind you when to replace the battery.

To close the cover match up snap-in hinges and gently press together until base and cover snap together. Test the installed Smoke Alarm - see section "Manually Testing your Smoke Alarm".

NOTE: You may hear a loud chirp when attaching the Battery Connectors to the Battery.

Battery Missing indicator

Some models are fitted with a warning flag which pops up when the battery is removed. This prevents the cover from closing when there is no battery in the unit. When the battery is being installed or changed, this flag must be held down while gently pushing the Battery into the Battery Holder. (Figure 7(a)).

Figure 7(a)

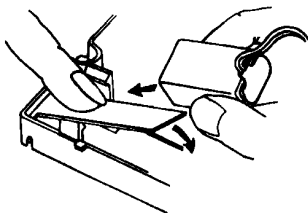

Looking after your Smoke Alarm

(a) Automatic Self-Test

The smoke chamber automatically tests itself every 40 seconds. If the chamber is degraded it will beep **without** the LED flashing at the same time. If this happens clean the unit. If the beeping persists and the beep does not coincide with an LED flash, return the unit for service (see "Getting your Smoke Alarm Serviced").

(b) Manually Testing your Smoke Alarm

It is recommended that you test your Smoke Alarm at least once a month to be sure the unit is working. It will also help you and your family to become familiar with the sound of the Alarm. When you press the Test Button it simulates the effect of smoke during a real fire. So, there is no need to test the Alarm with smoke.

Press and hold the Test Button until the Alarm sounds (it may take up to 10 seconds), (Figure 8). The alarm will stop sounding shortly after the Button is released. If the alarm fails to sound, follow this checklist.

1. Check Battery Connectors to be sure they are firmly snapped to the Battery.
2. Replace the Battery. (Check the date marked on the Cover when you last replaced the Battery).

Figure 8

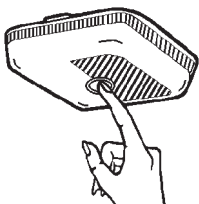
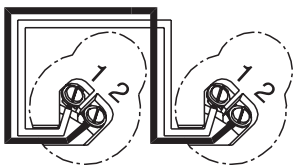

Figure 9



3. Check for any sign of contamination such as cobwebs or dust and clean the alarm as described on page 9 if necessary.

WARNING: Do not test with flame.

This can set fire to the alarm and damage the house. We do not recommend testing with smoke as the results can be misleading unless special apparatus is used.

(c) Replacing the Battery

A fresh Battery should last about one year. When Battery power is low and replacement is necessary, the Alarm will “beep” and the LED will flash at the same time about once per minute for at least 30 days. The battery must then be replaced. Replace the battery if the alarm does not sound when the Test Button is pressed. For maximum reliability, replace battery at least once a year.

Test the alarm for correct operation using the test button whenever the battery is replaced.

If the Power Indicator light ceases flashing, replace the battery. Be sure to replace the Battery as soon as possible to ensure proper operation and to avoid a leaking Battery. Leakage could cause damage to the Alarm, furniture, and carpeting.

For replacement batteries, refer to the label inside Smoke Alarm Cover.

WARNING: Use of any other battery may be detrimental to the operation of the Smoke Alarm.

(d) Cleaning your Smoke Alarm

Clean your Smoke Alarm regularly. Use a soft bristle brush or the brush attachment of your vacuum cleaner to remove dust from the sides and cover slots where the smoke enters. Keep cover closed while cleaning. Do not vacuum or brush inside the Smoke Alarm. To clean the cover, remove it completely and use only mild soap and water. Dry cover thoroughly before replacing it. **WARNING:** Do not paint your Smoke Alarm.

Other than the maintenance and cleaning described in this leaflet, no other customer servicing of this product is required. Repairs, when needed, must be performed by the manufacturer.

Interconnecting your Smoke Alarms

A maximum of 12 Ei105C Smoke Alarms may be wired together such that when one unit senses smoke all other units sound a warning. This helps ensure smoke alarms will be heard. The unit can be also connected to Ei100C Ionization type Smoke Alarms. Do not connect to any other device as it may damage the unit or affect performance.

A maximum of 5,000 feet (1,500 metres) of 18 AWG (0.82mm) wire can be used, (maximum resistance between detectors 50 ohm). The units are interconnected by wiring all the terminals marked 1 together, and all the terminals marked 2 together (as in figure 9 before screwing to ceiling). Draughts from wiring openings, conduit, or mounting boxes/holes, may blow smoke away from the sensing chamber, making it insensitive. It is essential that all such openings be closed by silicone sealant or similar.

After wiring together the Interconnect Smoke Alarms, test the first unit by pressing the button. All the detectors should alarm and the test button on the first unit will flash about once a second. Check all the other units similarly.

These Smoke Alarms should be interconnected only within the confines of a single family living unit. If they are connected between different units there may be excessive nuisance alarms. Everybody may not be aware that they are being tested or that it is a nuisance alarm caused by cooking etc.

Important Safeguards

When using household protective devices, basic safety precautions should always be followed, including those listed below:

- Please read all instructions.
- Rehearse emergency escape plans so everyone at home knows what to do in case the alarm sounds.
- For replacement batteries, refer to label inside smoke alarm.
- **NOTE:** Constant exposure to high or freezing temperatures or high humidity may reduce the life of the batteries.
- Do not disconnect battery to stop alarm sounding. (Fanning vigorously with a newspaper or similar will remove nuisance smoke from the Smoke Alarm and stop it sounding.)

- Do not attempt to recharge or burn batteries, as they may explode. Wrap in paper and discard normally.
- When removing battery, handle carefully to avoid possible eye damage or skin irritation if battery has leaked or corroded.
- To maintain sensitivity to smoke, do not paint or cover smoke alarm in any manner; do not permit any accumulation of cobwebs, dust or grease.
- If unit has been damaged in any way or does not function properly, do not attempt a repair. Return Smoke Alarm (see - Getting your Smoke Alarm Serviced page 12.)
- This appliance is intended for household use ONLY and not for commercial or industrial use.
- This is not a portable product. It must be mounted following the instructions in this instruction leaflet.
- Smoke Alarms are not a substitute for insurance. The supplier or manufacturer is not your insurer.

(b) Limitations of Smoke Alarms

Smoke Alarms have significantly helped to reduce the number of fire fatalities in countries where they are widely installed.

However independent authorities have stated that they may be ineffective in some circumstances. There are a number of reasons for this:

- Smoke Alarms will not work if the batteries are depleted or if they are not connected, or if the wrong type of battery is used. Test regularly and replace batteries at least yearly or when depleted.
- Smoke Alarms will not detect fire if sufficient smoke does not reach the alarm. Smoke may be prevented from reaching the Alarm if the fire is too far away, for example, if the fire is on another floor, behind a closed door, in a chimney, in a wall cavity, or if the prevailing air draughts carry the smoke away. Installing smoke alarms on both sides of closed doors and installing more than one smoke alarm as recommended in this leaflet very significantly improve the probability of early detection.
- The Smoke Alarm may not be heard.
- A smoke alarm may not wake a person who has taken drugs or alcohol.
- Smoke Alarms may not detect every type of fire to give sufficient early warning. They are particularly ineffective with: fires caused by smoking in bed, escaping gas, violent explosions. poor storage of flammable rags and/or liquids, (for example petrol, paint, spirits etc), overloaded electrical circuits, arson, children playing with matches.
- Smoke Alarms don't last indefinitely. The manufacturer recommends replacement after 10 years as a precaution.

Planning your Escape for when the Alarm goes off

Use the Smoke Alarm Test Button to familiarize your family with the Alarm sound and to practice fire drills regularly with all family members. Draw up a floor plan that will show each member at least 2 escape routes from each room in the house. Children tend to hide when they don't know what to do. Teach children how to escape, open windows, and use roll up fire ladders and stools without adult help. Make sure they know what to do if the alarm goes off - see below.

1. Check room doors for heat or smoke. Do not open a hot door. Use an alternate escape route. Close doors behind you as you leave.



2. If smoke is heavy, crawl out, staying close to floor. Take short breaths, if possible, through a wet cloth or hold your breath. More people die from smoke inhalation than from flames.



3. Get out as fast as you can. Do not stop for packing. Have a prearranged meeting place outside for all family members. Check everybody is there.



4. Call the Fire Brigade from a neighbour's house. Remember to give your name and address.



5. **NEVER** re-enter a burning house.



(b) FIRE SAFETY HINTS

Store petrol and other flammable materials in proper containers.

Discard oily or flammable rags.

Always use a metal fireplace screen and have chimneys cleaned regularly.

Replace worn or damaged sockets, switches, home wiring and cracked or frayed electrical cords and plugs.

Do not overload electrical circuits.

Keep matches away from children.

Never smoke in bed. In rooms where you do smoke, always check under cushions for smoldering cigarettes and ashes.

Service central heating systems regularly.

Be sure all electrical appliances and tools have a recognised approval label.

This device cannot protect all persons at all times. It may not protect against the three most common causes of fatal fires:

1. Smoking in bed.
2. Leaving children at home alone.
3. Cleaning with flammable liquids, such as petrol.

Further information can be obtained from the Home Office Publication entitled "Smoke Detectors in the Home" (FB2) or from your local fire prevention officer.

What is the best Smoke Alarm - Optical or Ionisation ?

Both types respond in all standard fires but each type may respond faster to particular fires as shown. Ei Electronics manufactures two complementary 10 Year Smoke Alarms , Optical Smoke Alarm Ei3105C and Ionisation Smoke Alarm Ei100TYC with built-in Lithium battery. For **dual** protection install each type.

Optical Sensor

Best for slow **smouldering** fires
- large smoke particles

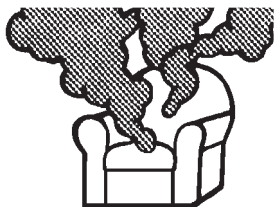

Ionisation Sensor

Best for fast **flaming** fires
- small smoke particles



The Home Office states (in FB2):

"If your home has more than one floor , at least one alarm should be fitted on each level. In this case a combination of Optical and Ionisation alarms, preferably interconnected, will give the best protection."

Getting your Smoke Alarm Serviced

If your Smoke Alarm fails to work after you have read the sections on "Connecting the battery" and "Looking after your Smoke Alarm" contact Customer Assistance at the nearest address given at the end of this leaflet. If it needs to be returned for repair or replacement put it in a padded box (battery

disconnected) and send it to "Customer Assistance and Information" at the nearest address given on the Smoke Alarm or in this leaflet. State the nature of the fault, where the Smoke Alarm was purchased and the date of purchase.

Five Year Product Guarantee (excluding battery)

Ei Electronics guarantees this product (excluding battery) against any defects that are due to faulty material or workmanship for a five year period after the original date of consumer purchase or receipt as a gift. This guarantee does not include damage to the product resulting from accident or misuse. It also excludes incidental and consequential damages. If the product should become defective within the warranty period, we will replace it free of charge. (see "Getting Your Smoke Alarm Serviced")

Do not interfere with the product or attempt to tamper with it. This will invalidate the guarantee.

IMPORTANT NOTICE

DUST & INSECT CONTAMINATION

All Smoke Alarms and particularly the optical (photoelectric) type are prone to dust and insect ingress which can cause false alarms.

The latest design, materials and manufacturing techniques have been used in the construction of our Alarms to minimize the effects of contamination. However it is impossible to completely eliminate the effect of dust and insect contamination, and therefore, to prolong the life of the Smoke Alarm you must ensure that it is kept clean so that excess dust does not build up. Any insects or cobwebs in the vicinity of the Smoke Alarm should be promptly removed.

In certain circumstances even with regular cleaning, contamination can build up in the smoke sensing chamber causing the alarm to sound. If this happens the alarm must be returned to us for servicing or replacement. Contamination is beyond our control, it is totally unpredictable and is considered normal wear and tear. For this reason, contamination is not covered by the guarantee and a charge is made for all servicing work.

If you experience persistent false alarms, in particular locations, due to contamination of the smoke chamber you could consider fitting our ionisation type Smoke Alarm. The principle of ionisation detection makes it less vulnerable to the effects of dust or insect contamination.

The crossed out wheelie bin symbol that is on your product indicates that this product should not be disposed of via the normal household waste stream. Proper disposal will prevent possible harm to the environment or to human health. When disposing of this product please separate it from other waste streams to ensure that it can be recycled in an environmentally sound manner. For more details on collection and proper disposal, please contact your local government office or the retailer where you purchased this product.



CE
0086

Ei Electronics, Shannon, Co. Clare, Ireland
08
DoP No.13-0001

EN14604:2005 + AC:2008

Smoke Alarm Devices:
Ei105B, Ei105C , Ei105H

Fire Safety

Nominal activation conditions/ sensitivity, response delay (response time) and performance under fire condition	Pass
Operational reliability	Pass
Tolerance to voltage supply	Pass
Response delay and temperature resistance	Pass
Vibration resistance	Pass
Humidity resistance	Pass
Corrosion resistance	Pass
Electrical stability	Pass

The Declaration of Performance No. 13-0001 may be consulted at www.eielectronics.com/compliance

Ei Electronics. Shannon, Co. Clare, Ireland.
e-mail: eielectronics@eiltd.ie

Ei Electronics. 9 Grundy St., Liverpool L5-9SG.
Phone: +44 (0)151 2981588. Fax: +44 (0)151 2073312.
e-mail: sales.uk@eiltd.ie

visit us at www.eielectronics.com