



Contactor,4kW/400V,AC operated



Powering Business Worldwide™

Part no. DILEM-10(415V50HZ,480V60HZ,

Article no. 051789

Delivery programme

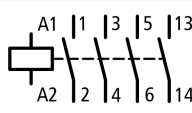
Product range				Contactors
Application				Mini Contactors for Motors and Resistive Loads
Subrange				DILEM contactors
Utilization category				AC-1: Non-inductive or slightly inductive loads, resistance furnaces AC-3: Squirrel-cage motors: starting, switching off during running AC-4: Squirrel-cage motors: starting, plugging, reversing, inching
Connection technique				Screw terminals
Description				With auxiliary contact
Pole				3 pole
Rated operational current				
AC-3				
380 V 400 V	I_e	A		9
AC-1				
Conventional free air thermal current, 3 pole, 50 - 60 Hz				
Open				
at 40 °C	$I_{th} = I_e$	A		22
enclosed	I_{th}	A		16
Conventional free air thermal current, 1 pole				
open	I_{th}	A		50
enclosed	I_{th}	A		40
Max. rating for three-phase motors, 50 - 60 Hz				
AC-3				
220 V 230 V	P	kW		2.2
380 V 400 V	P	kW		4
660 V 690 V	P	kW		4
AC-4				
220 V 230 V	P	kW		1.5
380 V 400 V	P	kW		3
660 V 690 V	P	kW		3
Contacts				
N/O = Normally open				1 N/O
Contact sequence				
For use with				...DILEM ...DILE
Actuating voltage				415 V 50 Hz, 480 V 60 Hz
Voltage AC/DC				AC operation

Approvals

Product Standards
UL File No.
UL CCN
CSA File No.
CSA Class No.
NA Certification
Specially designed for NA

IEC/EN 60947-4-1; UL 508; CSA-C22.2 No. 14-05; CE marking
E29096
NLDX
012528
3211-04
UL listed, CSA certified
No

General

Standards				IEC/EN 60947, VDE 0660, CSA, UL
Lifespan, mechanical; Coil 50/60 Hz	Operations	x 10^6		7

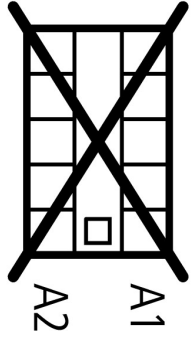
Lifespan, mechanical	Operations	x 10 ⁶	10
Maximum operating frequency		Ops./ h	
Mechanical		Ops./ h	9000
Climatic proofing			Damp heat, constant to IEC 60068-2-78 Damp heat, cyclic to IEC 60068-2-30
Ambient temperature		°C	
Open		°C	- 25 - 50
Enclosed		°C	- 25 - 40
Mounting position			As required except vertical with terminals A1/A2 at the bottom 
Mounting position			As required, except vertical with terminals A1/A2 at the bottom
Mechanical shock resistance (IEC/EN 60068-2-27)			
Half-sinusoidal shock, 10 ms			
Basic unit without auxiliary contact module			
Main contacts, make contacts		g	10
Main contacts Make/break contacts		g	10 / 8
Basic unit with auxiliary contact module			
Main contacts make contact		g	
Make		g	10
Auxiliary contacts Make/break contacts		g	20 / 20
Protection type			IP20
Protection against direct contact when actuated from front (EN 50274)			Finger and back-ofhand proof
Weight		kg	0.2
Terminal capacity of auxiliary and main contacts			
Solid		mm ²	1 x (0.75 - 2.5) 2 x (0.75 - 2.5)
Flexible with ferrule		mm ²	1 x (0.75 - 1.5) 2 x (0.75 - 1.5)
Solid or stranded		AWG	18 - 14
Terminal screw			M3.5
Pozidriv screwdriver		Size	2
Standard screwdriver		mm	0.8 x 5.5 1 x 6
Max. tightening torque		Nm	1.2
Terminal capacity springloaded terminals main and control circuits			
Solid		mm ²	1 x (1 - 2.5) 2 x (1 - 2.5)
Flexible with ferrule		mm ²	1 x (1 - 2.5) 2 x (1 - 2.5)
Standard screwdriver		mm	0.6 x 3.5
Main conducting paths			
Rated impulse withstand voltage	U _{imp}	V AC	6000
Overvoltage category/pollution degree			III/3
Rated insulation voltage	U _i	V AC	690
Rated operational voltage	U _e	V AC	690
Safe isolation to VDE 0106 Part 101 and Part 101/A1			

between coil and contacts		V AC	300
between the contacts		V AC	300
Making capacity (cos φ to IEC/EN 60947)		A	110
Breaking capacity			
220 V 230 V		A	90
380 V 400 V AC		A	90
500 V		A	64
660 690 V AC		A	42
Short-circuit protection maximum fuse			
Type "2" coordination	gL/gG	A	10
Type "1" coordination	gL/gG	A	20

AC

AC-1			
Rated operational current			
Conventional free air thermal current, 3 pole, 50 - 60 Hz			
Open			
at 40 °C	$I_{th} = I_e$	A	22
at 50 °C	$I_{th} = I_e$	A	20
at 55 °C	$I_{th} = I_e$	A	19
enclosed	I_{th}	A	16
Notes			At maximum permissible ambient air temperature.
Conventional free air thermal current, 1 pole			
open	I_{th}	A	50
enclosed	I_{th}	A	40
Notes			At maximum permissible ambient air temperature.
AC-3			
Rated operational current			
Open, 3-pole: 50 – 60 Hz			
Notes			At maximum permissible ambient air temperature.
220 V 230 V	I_e	A	9
240 V	I_e	A	9
380 V 400 V	I_e	A	9
415 V	I_e	A	9
440V	I_e	A	9
500 V	I_e	A	6.4
660 V 690 V	I_e	A	4.8
Motor rating	P	kWh	
220 V 230 V	P	kW	2.2
240V	P	kW	2.5
380 V 400 V	P	kW	4
415 V	P	kW	4.3
440 V	P	kW	4
500 V	P	kW	4
660 V 690 V	P	kW	4
AC-4			
Open, 3-pole: 50 – 60 Hz			
Notes			At maximum permissible ambient air temperature.
230 V	I_e	A	6.6
240 V	I_e	A	6.6
400 V	I_e	A	6.6
415 V	I_e	A	6.6
440 V	I_e	A	6.6
500 V	I_e	A	5

690 V	I_e	A	3.4
Motor rating	P	kWh	
230 V	P	kW	1.5
240 V	P	kW	1.8
400 V	P	kW	3
415 V	P	kW	3.1
440 V	P	kW	3
500 V	P	kW	3
690 V	P	kW	3

DC

Rated operational current, open	I_e		
DC - -1			
12 V	I_e	A	20
24 V	I_e	A	20
60 V	I_e	A	20
110 V	I_e	A	20
220 V	I_e	A	20
DC - 3			
12 V	I_e	A	8
24 V	I_e	A	8
60 V	I_e	A	4
110 V	I_e	A	3
DC - 5			
12 V	I_e	A	2.5
24 V	I_e	A	2.5
60 V	I_e	A	2.5
110 V	I_e	A	1.5
220 V	I_e	A	0.3
Current heat losses (3- or 4-pole)			
to I_{th}		W	2
at I_e to AC-3/400 V		W	0.5

Magnet systems

Voltage tolerance		$x U_c$	
Single-voltage coil 50 Hz and dual-voltage coil 50 Hz, 60 Hz	Pick-up	$x U_c$	0.8 - 1.1
Dual-frequency coil 50/60 Hz	Pick-up	$x U_c$	0.85 - 1.1
Power consumption			
AC operation			
Single-voltage coil 50 Hz and dual-voltage coil 50 Hz, 60 Hz	Pick-up	VA	25
Single-voltage coil 50 Hz and dual-voltage coil 50 Hz, 60 Hz	Pick-up	W	22
Single-voltage coil 50 Hz and dual-voltage coil 50 Hz, 60 Hz	Sealing	VA	4.6
Single-voltage coil 50 Hz and dual-voltage coil 50 Hz, 60 Hz	Sealing	W	1.3
Dual-frequency coil 50/60 Hz at 50 Hz	Pick-up	VA	30
Dual-frequency coil 50/60 Hz at 50 Hz	Pick-up	W	26
Dual-frequency coil 50/60 Hz at 50 Hz	Sealing	VA	5.4
Dual-frequency coil 50/60 Hz at 50 Hz	Sealing	W	1.6
Dual-frequency coil 50/60 Hz at 60 Hz	Pick-up	VA	29
Dual-frequency coil 50/60 Hz at 60 Hz	Pick-up	W	24
Dual-frequency coil 50/60 Hz at 60 Hz	Sealing	VA	3.9
Dual-frequency coil 50/60 Hz at 60 Hz	Sealing	W	1.1
DC operation			
Notes			Smoothed DC voltage or three-phase bridge rectifier
Duty factor		% DF	100
Switching times at 100 % U_c			

Make contact		ms	
Closing delay		ms	
Closing delay min.		ms	14
Closing delay max.		ms	21
Opening delay		ms	
Opening delay min.		ms	8
Opening delay max.		ms	18
Closing delay with top mounting auxiliary contact		ms	max. 45
Reversing contactors			
Changeover time at 110 % U _c		ms	
Changeover time min.		ms	16
Changeover time max.		ms	21
Arcing time at 690 V AC		ms	max. 12

Auxiliary contacts

Positive operating contacts to ZH 1/457, including auxiliary contact module			Yes
Rated impulse withstand voltage	U _{imp}	V AC	6000
Rated insulation voltage	U _i	V AC	690
Rated operational voltage	U _e	V	
Rated operational voltage	U _e	V AC	600
Safe isolation to VDE 0106 Part 101 and Part 101/A1			
between coil and auxiliary contacts		V AC	300
between the auxiliary contacts		V AC	300
Rated operational current	I _e	A	
AC-15			
220 V 240 V	I _e	A	6
380 V 415 V	I _e	A	3
500 V	I _e	A	1.5
DC-13			
Contacts in series:		A	
1	24 V	A	2.5
2	60 V	A	2.5
3	100 V	A	1.5
3	220 V	A	0.5
Control circuit reliability (at U _e = 24 V DC, U _{min} = 17 V, I _{min} = 5.4 mA)	Failure rate	λ	<10 ⁻⁸ , < one failure at 100 million operations
Component lifespan at U _e = 240 V			
AC-15	Operations	x 10 ⁶	0.2
DC-13			
L/R = 50 ms: 2 contacts in series at I _e = 0.5 A	Operations	x 10 ⁶	0.15
Notes			Switch-on and switch-off conditions based on DC-13, time constant as specified
Short-circuit rating without welding			
Maximum overcurrent protective device			
Short-circuit protection only			PKZM0-4
Short-circuit protection maximum fuse			
500 V		A gG/ gL	6
500 V		A fast	10
Current heat loss at I _{th}			
Per contact		W	0.2

Technical data ETIM 4.0

Number of main contacts as N/Os			3
Rated operation current I _e at AC-1, 400 V			22
Connection type main circuit			Screw connection
Rated control voltage U _s at AC 60HZ		V	480
Number of auxiliary contacts as N/Os			1
Rated control voltage U _s at AC 50HZ		V	415
Number of auxiliary contacts as N/Cs			0
Suitable for rail-mounting			No
Rated control voltage U _s at DC		V	0
Voltage type for actuation			AC
Rated operation current I _e at AC-3, 400 V		A	9
Number of N/Cs as main contact			0
Motor rating at AC-3, 400 V		kWh	4

Characteristics

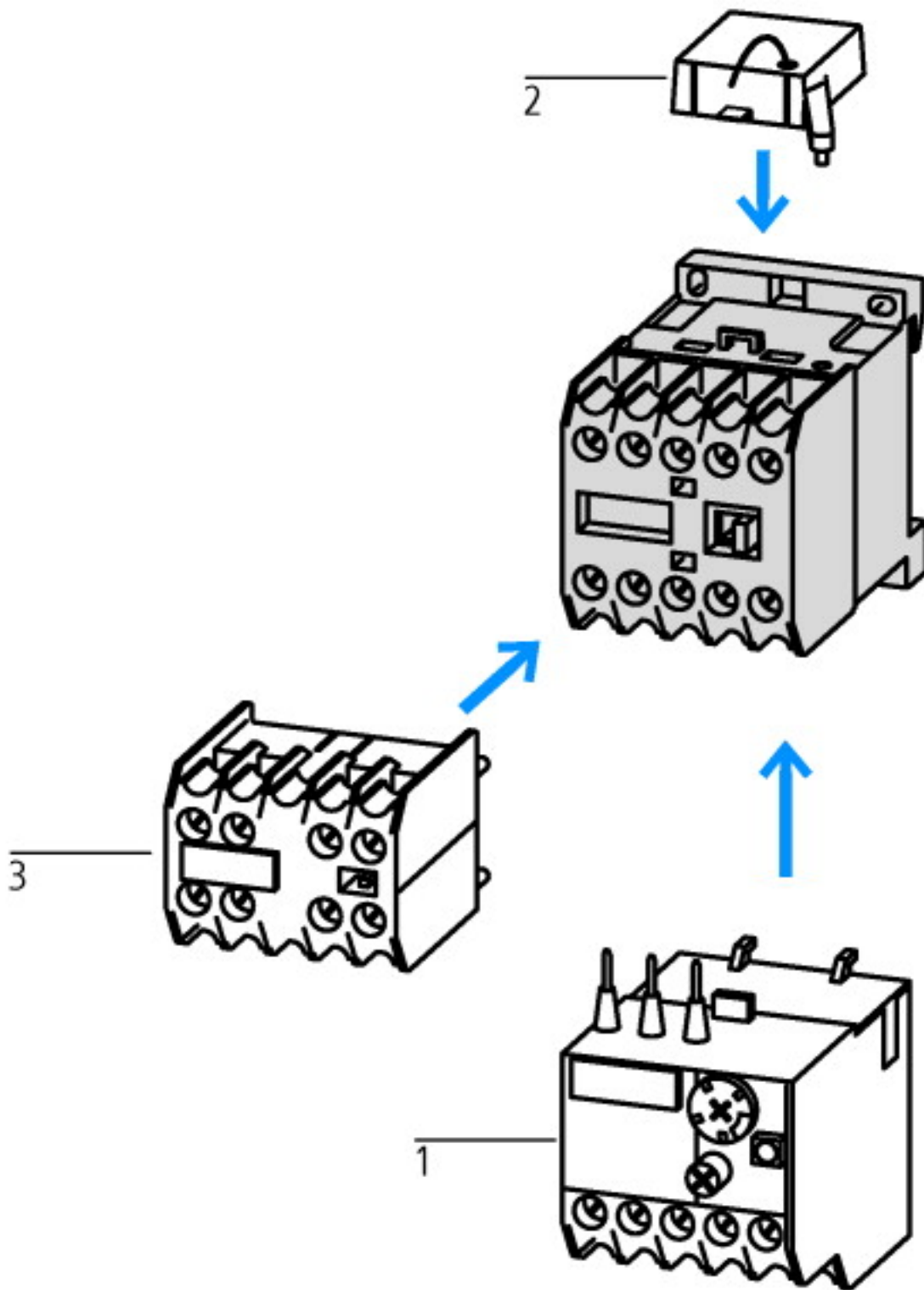

- 1: Overload relay
 - 2: Suppressor
 - 3: Auxiliary contact modules
- Enclosure totally insulated

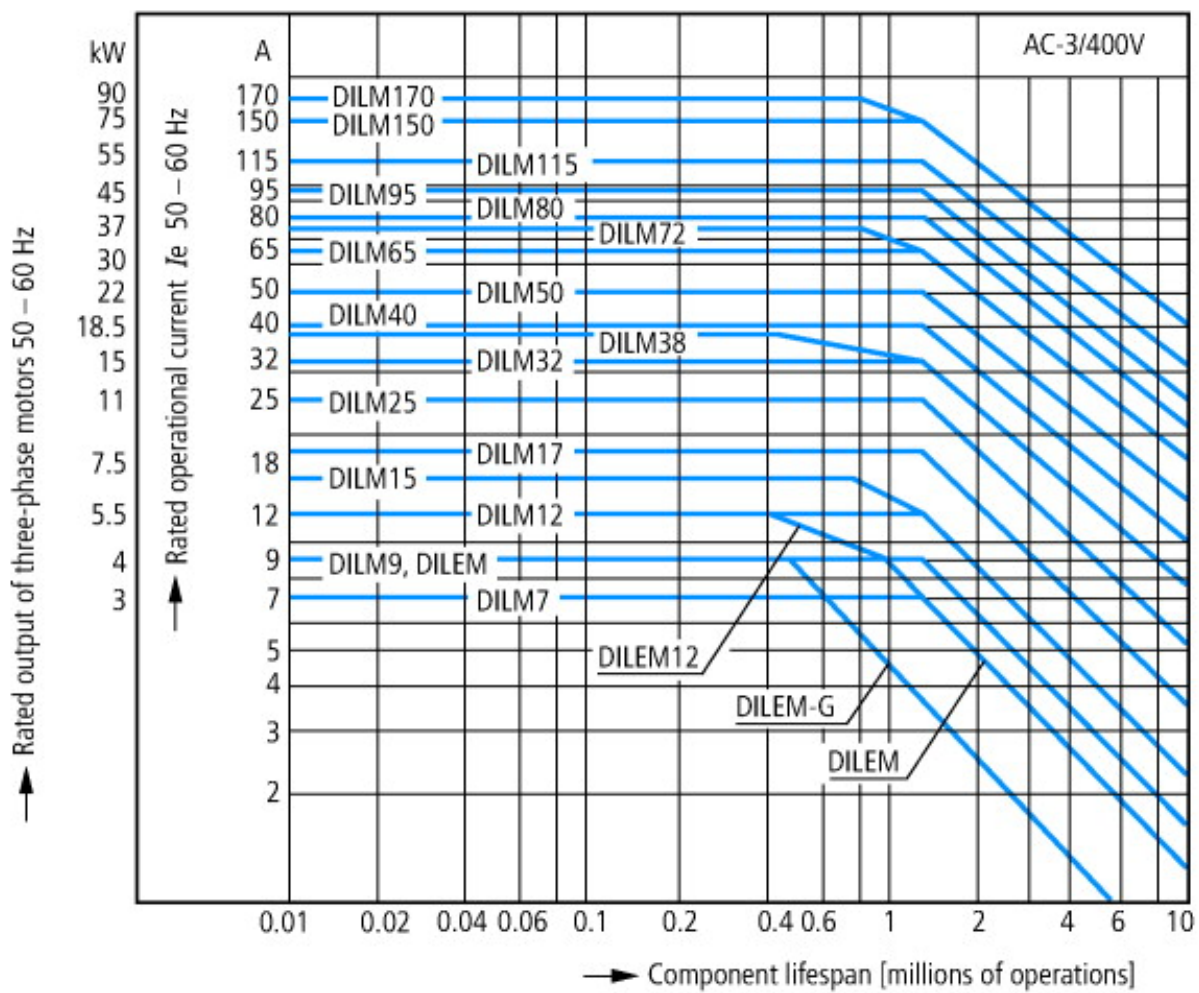

- Squirrel-cage motor
- Operating characteristics
- Starting: from rest
- Stopping: after attaining full running speed
- Electrical characteristics
- Make: up to 6 x rated motor current
- Break: up to 1 x rated motor current
- Utilization category
- 100 % AC-3
- Typical applications
- Compressors
- Lifts
- Mixers
- Pumps
- Escalators
- Agitators
- Fans
- Conveyor belts
- Centrifuges
- Hinged flaps
- Bucket-elevators
- Air conditioning system
- General drives in manufacturing and processing machines

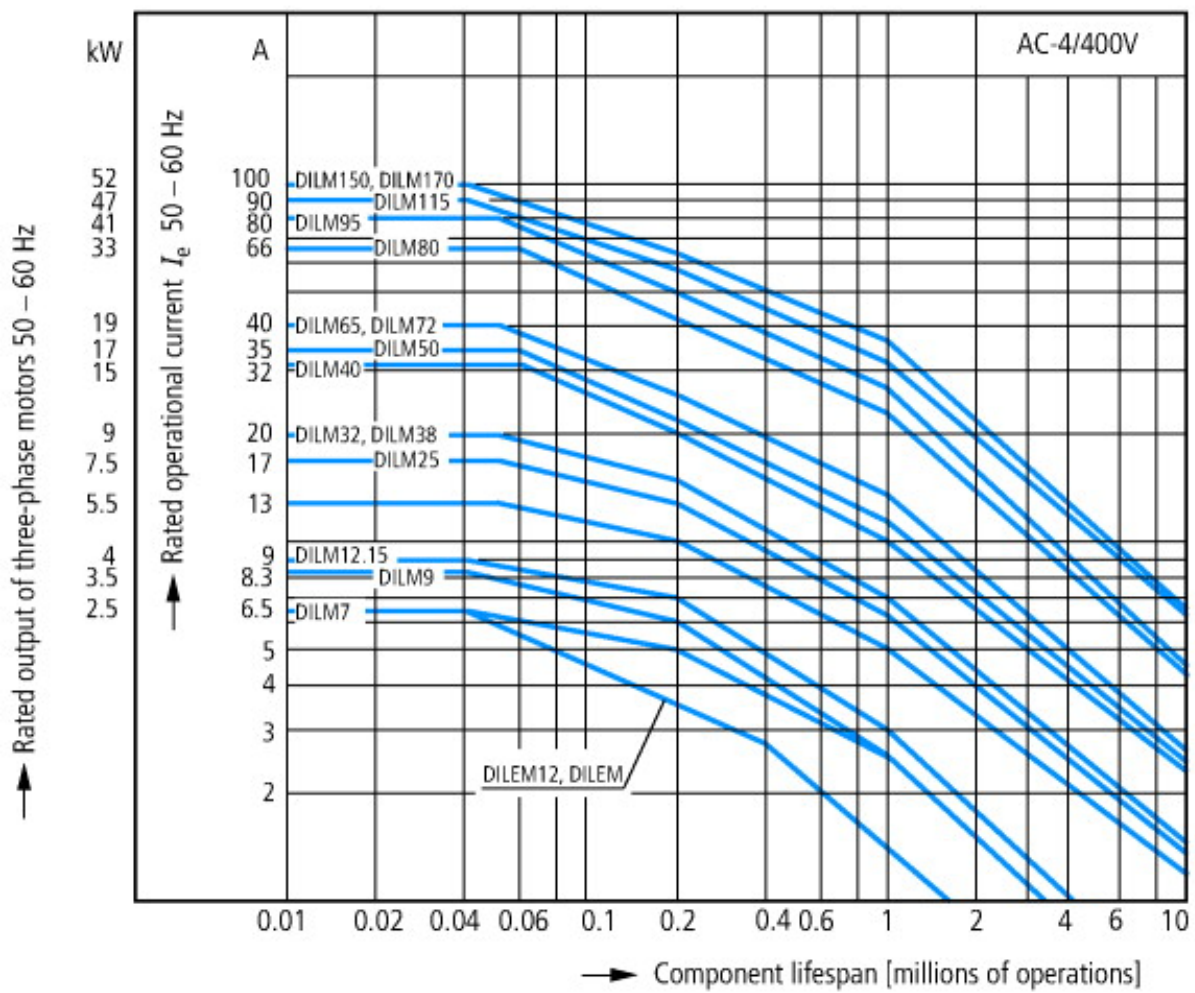

- Extreme switching duty
- Squirrel-cage motor
- Operating characteristics
- Inching, plugging, reversing
- Electrical characteristics
- Make: up to 6 x rated motor current
- Break: up to 6 x rated motor current
- Utilization category
- 100 % AC-4
- Typical applications
- Printing presses
- Wire-drawing machines
- Centrifuges
- Special drives for manufacturing and processing machines

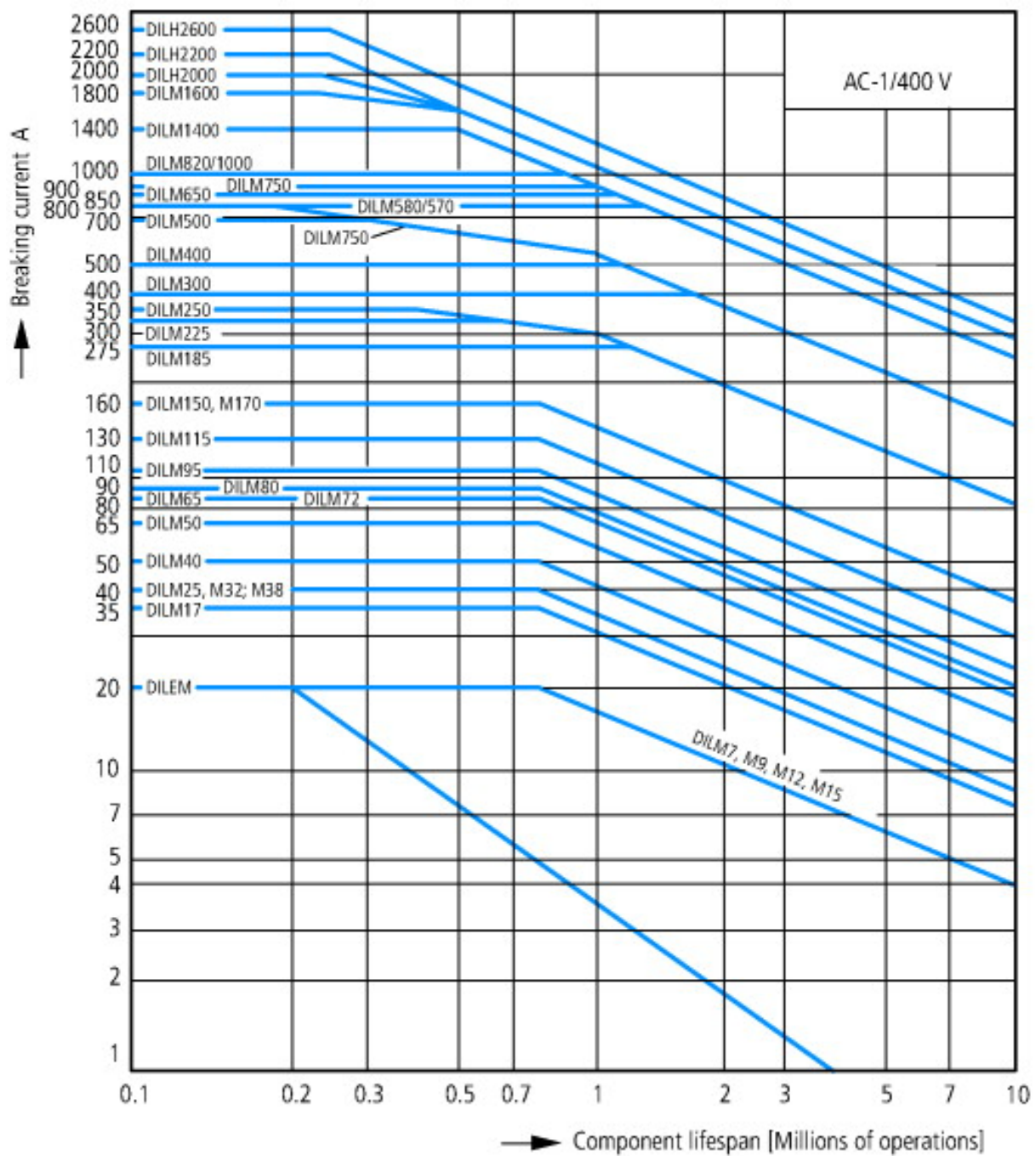

Switching duty for non-motor loads, 3-pole, 4-pole
 Operating characteristics
 Non-inductive or slightly inductive loads
 Electrical characteristics
 Make: 1 x rated current
 Break: 1 x rated current
 Utilization category
 100 % AC-1
 Typical applications
 Electric heat

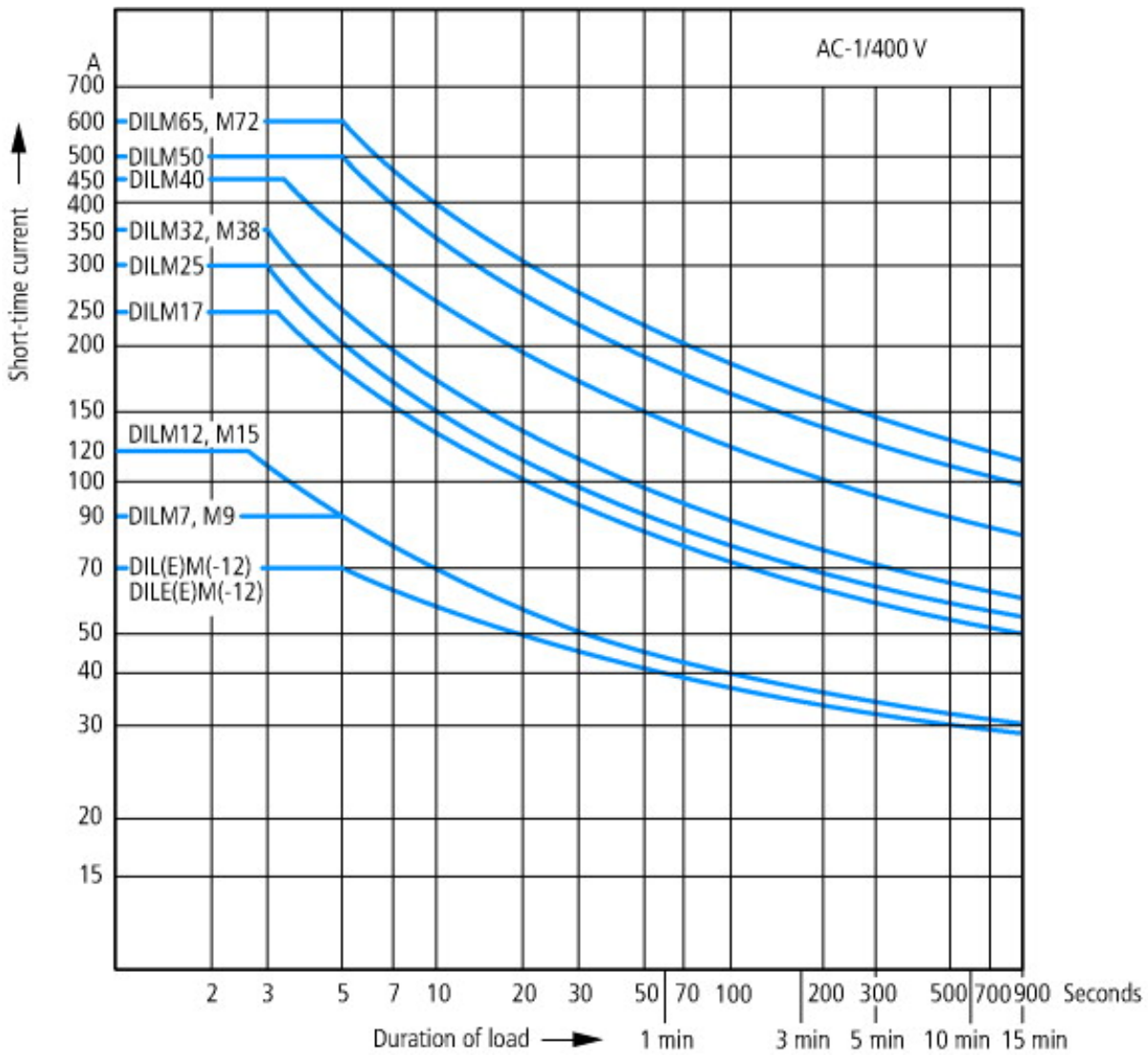

Short-time loading, 3-pole
Time interval between two loading cycles: 15 minutes

Dimensions

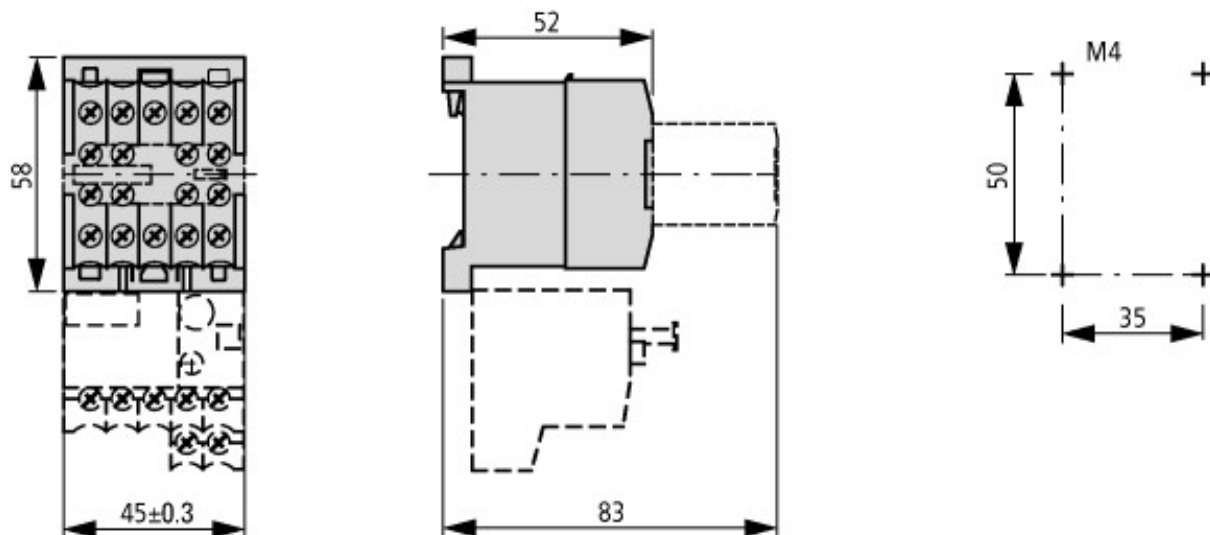

Additional product information (links)

IL03407009Z (AWA2100-0882) Mini contactor relay

IL03407009Z (AWA2100-0882) Mini contactor relay

ftp://ftp.moeller.net/DOCUMENTATION/AWA_INSTRUCTIONS/IL03407009Z2010_10.pdf

<http://de.ecat.moeller.net/flip-cat/?edition=HPLTE&startpage=5.84>