



**Contactor,4kW/400V,AC operated**



Powering Business Worldwide™

**Part no.** DILEM-01(230V50HZ,240V60HZ,

**Article no.** 051795

**Delivery programme**

Product range			Contactors
Application			Mini Contactors for Motors and Resistive Loads
Subrange			DILEM contactors
Utilization category			AC-1: Non-inductive or slightly inductive loads, resistance furnaces AC-3: Squirrel-cage motors: starting, switching off during running AC-4: Squirrel-cage motors: starting, plugging, reversing, inching
Connection technique			Screw terminals
Description			With auxiliary contact
Pole			3 pole
Rated operational current			
AC-3			
380 V 400 V	$I_e$	A	9
AC-1			
Conventional free air thermal current, 3 pole, 50 - 60 Hz			
Open			
at 40 °C	$I_{th} = I_e$	A	22
enclosed	$I_{th}$	A	16
Conventional free air thermal current, 1 pole			
open	$I_{th}$	A	50
enclosed	$I_{th}$	A	40
Max. rating for three-phase motors, 50 - 60 Hz			
AC-3			
220 V 230 V	P	kW	2.2
380 V 400 V	P	kW	4
660 V 690 V	P	kW	4
AC-4			
220 V 230 V	P	kW	1.5
380 V 400 V	P	kW	3
660 V 690 V	P	kW	3
Contacts			
N/C = Normally closed			1 N/C
Contact sequence			
For use with			...DILE
Actuating voltage			230 V 50 Hz, 240 V 60 Hz
Voltage AC/DC			AC operation

**Approvals**

Product Standards	IEC/EN 60947-4-1; UL 508; CSA-C22.2 No. 14-05; CE marking
UL File No.	E29096
UL CCN	NLDX
CSA File No.	012528
CSA Class No.	3211-04
NA Certification	UL listed, CSA certified
Specially designed for NA	No

**General**

Standards			IEC/EN 60947, VDE 0660, CSA, UL
Lifespan, mechanical; Coil 50/60 Hz	Operations	x $10^6$	7

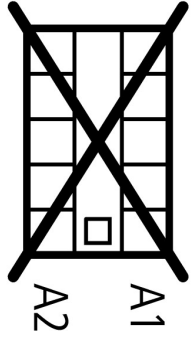
Lifespan, mechanical	Operations	x 10 <sup>6</sup>	10
Maximum operating frequency		Ops./ h	
Mechanical		Ops./ h	9000
Climatic proofing			Damp heat, constant to IEC 60068-2-78 Damp heat, cyclic to IEC 60068-2-30
Ambient temperature		°C	
Open		°C	- 25 - 50
Enclosed		°C	- 25 - 40
Mounting position			As required except vertical with terminals A1/A2 at the bottom 
Mounting position			As required, except vertical with terminals A1/A2 at the bottom
Mechanical shock resistance (IEC/EN 60068-2-27)			
Half-sinusoidal shock, 10 ms			
Basic unit without auxiliary contact module			
Main contacts, make contacts		g	10
Main contacts Make/break contacts		g	10 / 8
Basic unit with auxiliary contact module			
Main contacts make contact		g	
Make		g	10
Auxiliary contacts Make/break contacts		g	20 / 20
Protection type			IP20
Protection against direct contact when actuated from front (EN 50274)			Finger and back-ofhand proof
Weight		kg	0.2
Terminal capacity of auxiliary and main contacts			
Solid		mm <sup>2</sup>	1 x (0.75 - 2.5) 2 x (0.75 - 2.5)
Flexible with ferrule		mm <sup>2</sup>	1 x (0.75 - 1.5) 2 x (0.75 - 1.5)
Solid or stranded		AWG	18 - 14
Terminal screw			M3.5
Pozidriv screwdriver		Size	2
Standard screwdriver		mm	0.8 x 5.5 1 x 6
Max. tightening torque		Nm	1.2
Terminal capacity springloaded terminals main and control circuits			
Solid		mm <sup>2</sup>	1 x (1 - 2.5) 2 x (1 - 2.5)
Flexible with ferrule		mm <sup>2</sup>	1 x (1 - 2.5) 2 x (1 - 2.5)
Standard screwdriver		mm	0.6 x 3.5
<b>Main conducting paths</b>			
Rated impulse withstand voltage	U <sub>imp</sub>	V AC	6000
Overvoltage category/pollution degree			III/3
Rated insulation voltage	U <sub>i</sub>	V AC	690
Rated operational voltage	U <sub>e</sub>	V AC	690
Safe isolation to VDE 0106 Part 101 and Part 101/A1			

between coil and contacts		V AC	300
between the contacts		V AC	300
Making capacity (cos φ to IEC/EN 60947)		A	110
Breaking capacity			
220 V 230 V		A	90
380 V 400 V AC		A	90
500 V		A	64
660 690 V AC		A	42
Short-circuit protection maximum fuse			
Type "2" coordination	gL/gG	A	10
Type "1" coordination	gL/gG	A	20

## AC

AC-1			
Rated operational current			
Conventional free air thermal current, 3 pole, 50 - 60 Hz			
Open			
at 40 °C	$I_{th} = I_e$	A	22
at 50 °C	$I_{th} = I_e$	A	20
at 55 °C	$I_{th} = I_e$	A	19
enclosed	$I_{th}$	A	16
Notes			At maximum permissible ambient air temperature.
Conventional free air thermal current, 1 pole			
open	$I_{th}$	A	50
enclosed	$I_{th}$	A	40
Notes			At maximum permissible ambient air temperature.
AC-3			
Rated operational current			
Open, 3-pole: 50 – 60 Hz			
Notes			At maximum permissible ambient air temperature.
220 V 230 V	$I_e$	A	9
240 V	$I_e$	A	9
380 V 400 V	$I_e$	A	9
415 V	$I_e$	A	9
440V	$I_e$	A	9
500 V	$I_e$	A	6.4
660 V 690 V	$I_e$	A	4.8
Motor rating	P	kWh	
220 V 230 V	P	kW	2.2
240V	P	kW	2.5
380 V 400 V	P	kW	4
415 V	P	kW	4.3
440 V	P	kW	4
500 V	P	kW	4
660 V 690 V	P	kW	4
AC-4			
Open, 3-pole: 50 – 60 Hz			
Notes			At maximum permissible ambient air temperature.
230 V	$I_e$	A	6.6
240 V	$I_e$	A	6.6
400 V	$I_e$	A	6.6
415 V	$I_e$	A	6.6
440 V	$I_e$	A	6.6
500 V	$I_e$	A	5

690 V	$I_e$	A	3.4
Motor rating	P	kWh	
230 V	P	kW	1.5
240 V	P	kW	1.8
400 V	P	kW	3
415 V	P	kW	3.1
440 V	P	kW	3
500 V	P	kW	3
690 V	P	kW	3

## DC

Rated operational current, open	$I_e$		
DC - -1			
12 V	$I_e$	A	20
24 V	$I_e$	A	20
60 V	$I_e$	A	20
110 V	$I_e$	A	20
220 V	$I_e$	A	20
DC - 3			
12 V	$I_e$	A	8
24 V	$I_e$	A	8
60 V	$I_e$	A	4
110 V	$I_e$	A	3
DC - 5			
12 V	$I_e$	A	2.5
24 V	$I_e$	A	2.5
60 V	$I_e$	A	2.5
110 V	$I_e$	A	1.5
220 V	$I_e$	A	0.3
Current heat losses (3- or 4-pole)			
to $I_{th}$		W	2
at $I_e$ to AC-3/400 V		W	0.5

## Magnet systems

Voltage tolerance		$x U_c$	
Single-voltage coil 50 Hz and dual-voltage coil 50 Hz, 60 Hz	Pick-up	$x U_c$	0.8 - 1.1
Dual-frequency coil 50/60 Hz	Pick-up	$x U_c$	0.85 - 1.1
Power consumption			
AC operation			
Single-voltage coil 50 Hz and dual-voltage coil 50 Hz, 60 Hz	Pick-up	VA	25
Single-voltage coil 50 Hz and dual-voltage coil 50 Hz, 60 Hz	Pick-up	W	22
Single-voltage coil 50 Hz and dual-voltage coil 50 Hz, 60 Hz	Sealing	VA	4.6
Single-voltage coil 50 Hz and dual-voltage coil 50 Hz, 60 Hz	Sealing	W	1.3
Dual-frequency coil 50/60 Hz at 50 Hz	Pick-up	VA	30
Dual-frequency coil 50/60 Hz at 50 Hz	Pick-up	W	26
Dual-frequency coil 50/60 Hz at 50 Hz	Sealing	VA	5.4
Dual-frequency coil 50/60 Hz at 50 Hz	Sealing	W	1.6
Dual-frequency coil 50/60 Hz at 60 Hz	Pick-up	VA	29
Dual-frequency coil 50/60 Hz at 60 Hz	Pick-up	W	24
Dual-frequency coil 50/60 Hz at 60 Hz	Sealing	VA	3.9
Dual-frequency coil 50/60 Hz at 60 Hz	Sealing	W	1.1
DC operation			
Notes			Smoothed DC voltage or three-phase bridge rectifier
Duty factor		% DF	100
Switching times at 100 % $U_c$			

Make contact		ms	
Closing delay		ms	
Closing delay min.		ms	14
Closing delay max.		ms	21
Opening delay		ms	
Opening delay min.		ms	8
Opening delay max.		ms	18
Closing delay with top mounting auxiliary contact		ms	max. 45
Reversing contactors			
Changeover time at 110 % U <sub>c</sub>		ms	
Changeover time min.		ms	16
Changeover time max.		ms	21
Arcing time at 690 V AC		ms	max. 12

### Auxiliary contacts

Positive operating contacts to ZH 1/457, including auxiliary contact module			Yes
Rated impulse withstand voltage	U <sub>imp</sub>	V AC	6000
Rated insulation voltage	U <sub>i</sub>	V AC	690
Rated operational voltage	U <sub>e</sub>	V	
Rated operational voltage	U <sub>e</sub>	V AC	600
Safe isolation to VDE 0106 Part 101 and Part 101/A1			
between coil and auxiliary contacts		V AC	300
between the auxiliary contacts		V AC	300
Rated operational current	I <sub>e</sub>	A	
AC-15			
220 V 240 V	I <sub>e</sub>	A	6
380 V 415 V	I <sub>e</sub>	A	3
500 V	I <sub>e</sub>	A	1.5
DC-13			
Contacts in series:		A	
1	24 V	A	2.5
2	60 V	A	2.5
3	100 V	A	1.5
3	220 V	A	0.5
Control circuit reliability (at U <sub>e</sub> = 24 V DC, U <sub>min</sub> = 17 V, I <sub>min</sub> = 5.4 mA)	Failure rate	λ	<10 <sup>-8</sup> , < one failure at 100 million operations
Component lifespan at U <sub>e</sub> = 240 V			
AC-15	Operations	x 10 <sup>6</sup>	0.2
DC-13			
L/R = 50 ms: 2 contacts in series at I <sub>e</sub> = 0.5 A	Operations	x 10 <sup>6</sup>	0.15
Notes			Switch-on and switch-off conditions based on DC-13, time constant as specified
Short-circuit rating without welding			
Maximum overcurrent protective device			
Short-circuit protection only			PKZM0-4
Short-circuit protection maximum fuse			
500 V		A gG/ gL	6
500 V		A fast	10
Current heat loss at I <sub>th</sub>			
Per contact		W	0.2

## Technical data ETIM 4.0

Number of main contacts as N/Os			3
Rated operation current I <sub>e</sub> at AC-1, 400 V			22
Connection type main circuit			Screw connection
Rated control voltage U <sub>s</sub> at AC 60HZ		V	240
Number of auxiliary contacts as N/Os			0
Rated control voltage U <sub>s</sub> at AC 50HZ		V	230
Number of auxiliary contacts as N/Cs			1
Suitable for rail-mounting			No
Rated control voltage U <sub>s</sub> at DC		V	0
Voltage type for actuation			AC
Rated operation current I <sub>e</sub> at AC-3, 400 V		A	9
Number of N/Cs as main contact			0
Motor rating at AC-3, 400 V		kWh	4

## Characteristics

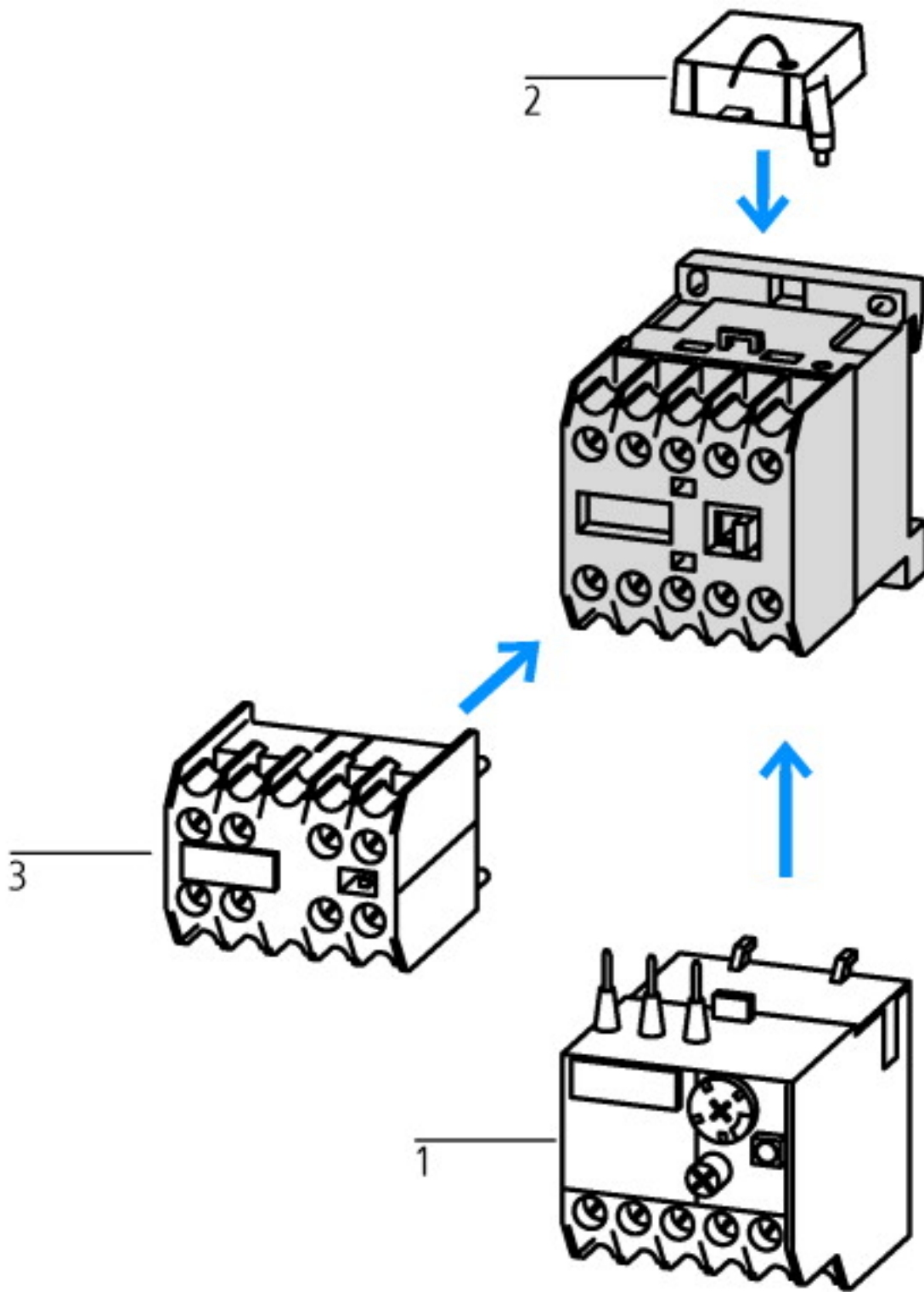

1: Overload relay  
 2: Suppressor  
 3: Auxiliary contact modules  
 Enclosure totally insulated

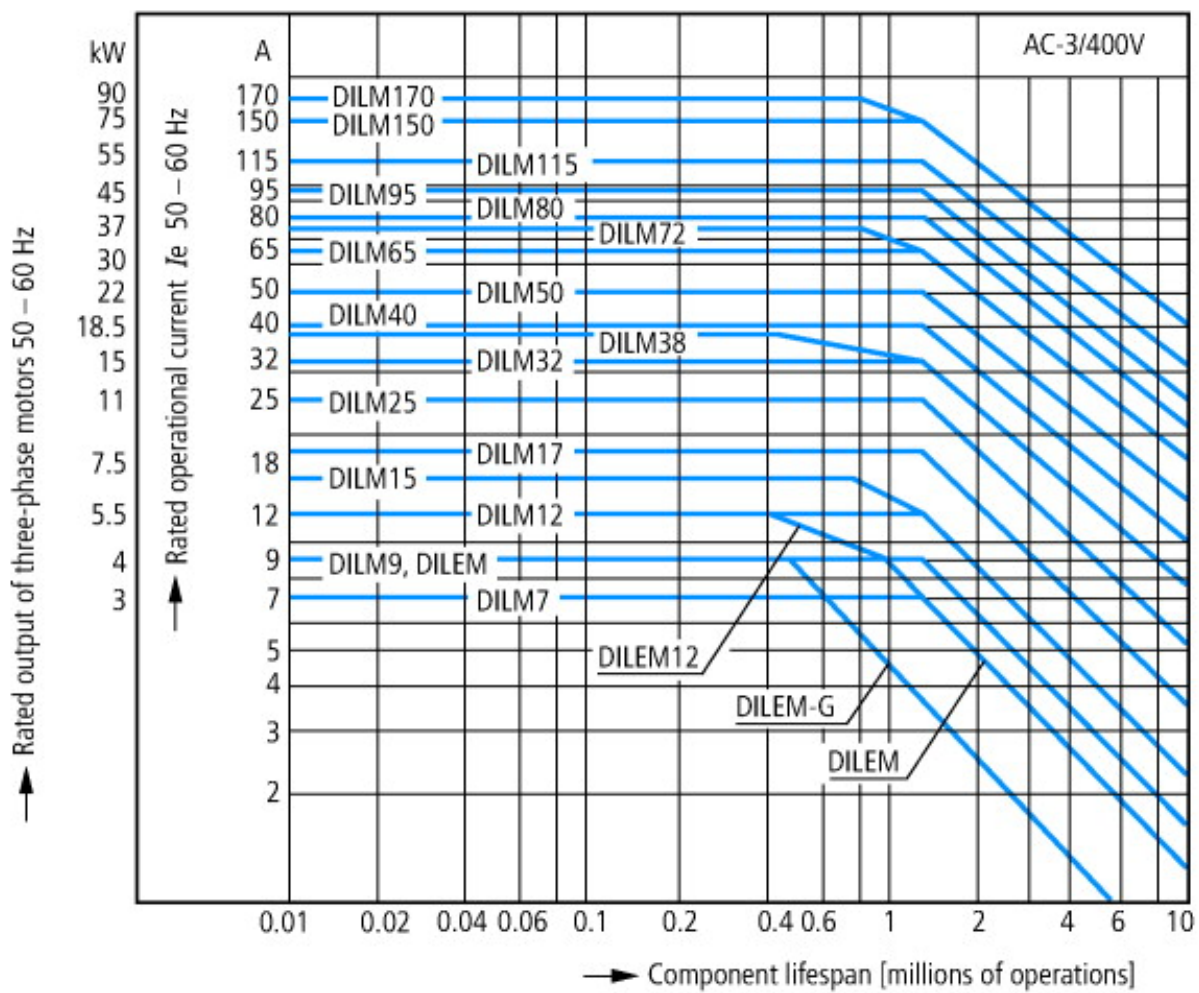

- Squirrel-cage motor
- Operating characteristics
- Starting: from rest
- Stopping: after attaining full running speed
- Electrical characteristics
- Make: up to 6 x rated motor current
- Break: up to 1 x rated motor current
- Utilization category
- 100 % AC-3
- Typical applications
- Compressors
- Lifts
- Mixers
- Pumps
- Escalators
- Agitators
- Fans
- Conveyor belts
- Centrifuges
- Hinged flaps
- Bucket-elevators
- Air conditioning system
- General drives in manufacturing and processing machines



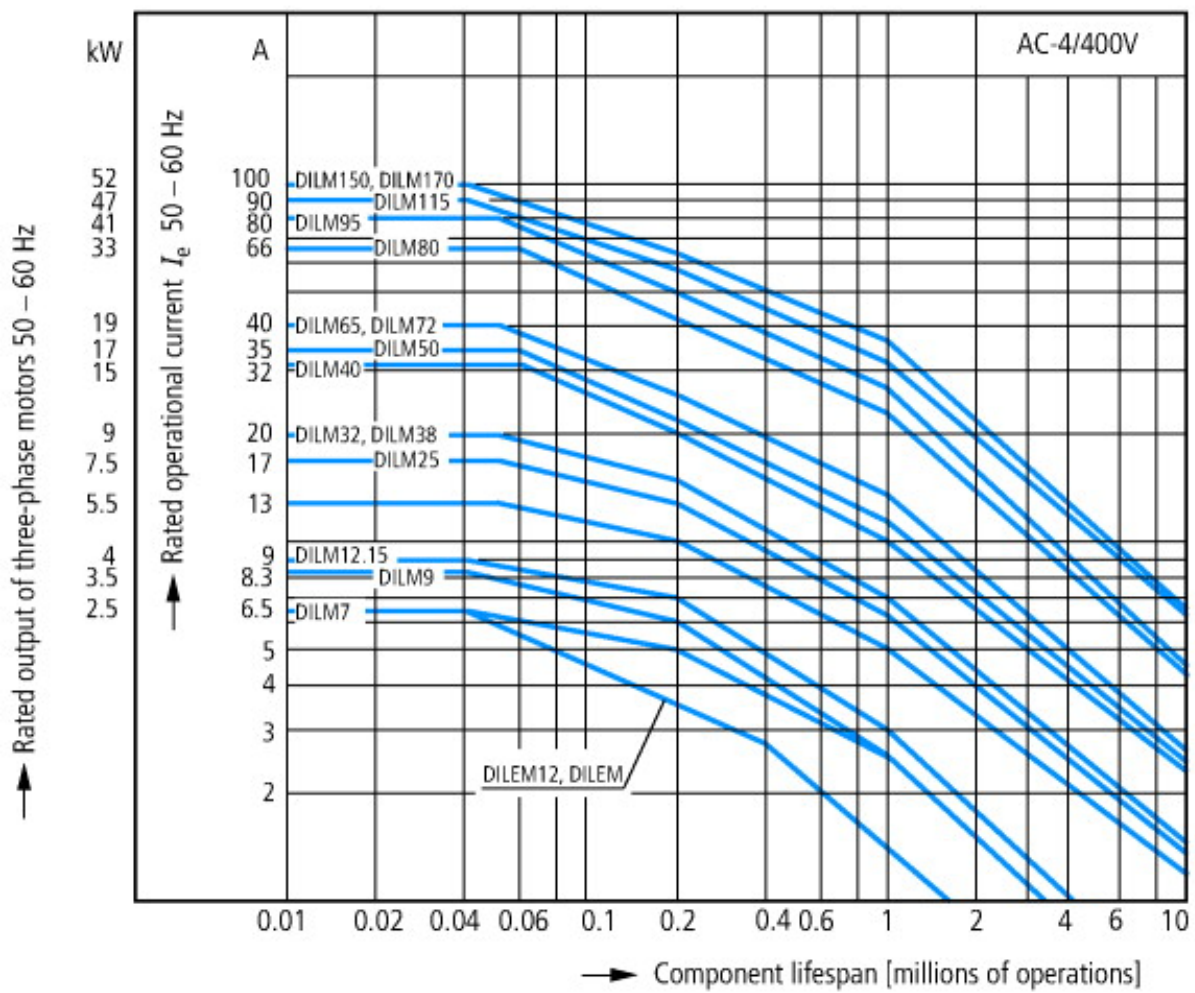

- Extreme switching duty
- Squirrel-cage motor
- Operating characteristics
- Inching, plugging, reversing
- Electrical characteristics
- Make: up to 6 x rated motor current
- Break: up to 6 x rated motor current
- Utilization category
- 100 % AC-4
- Typical applications
- Printing presses
- Wire-drawing machines
- Centrifuges
- Special drives for manufacturing and processing machines

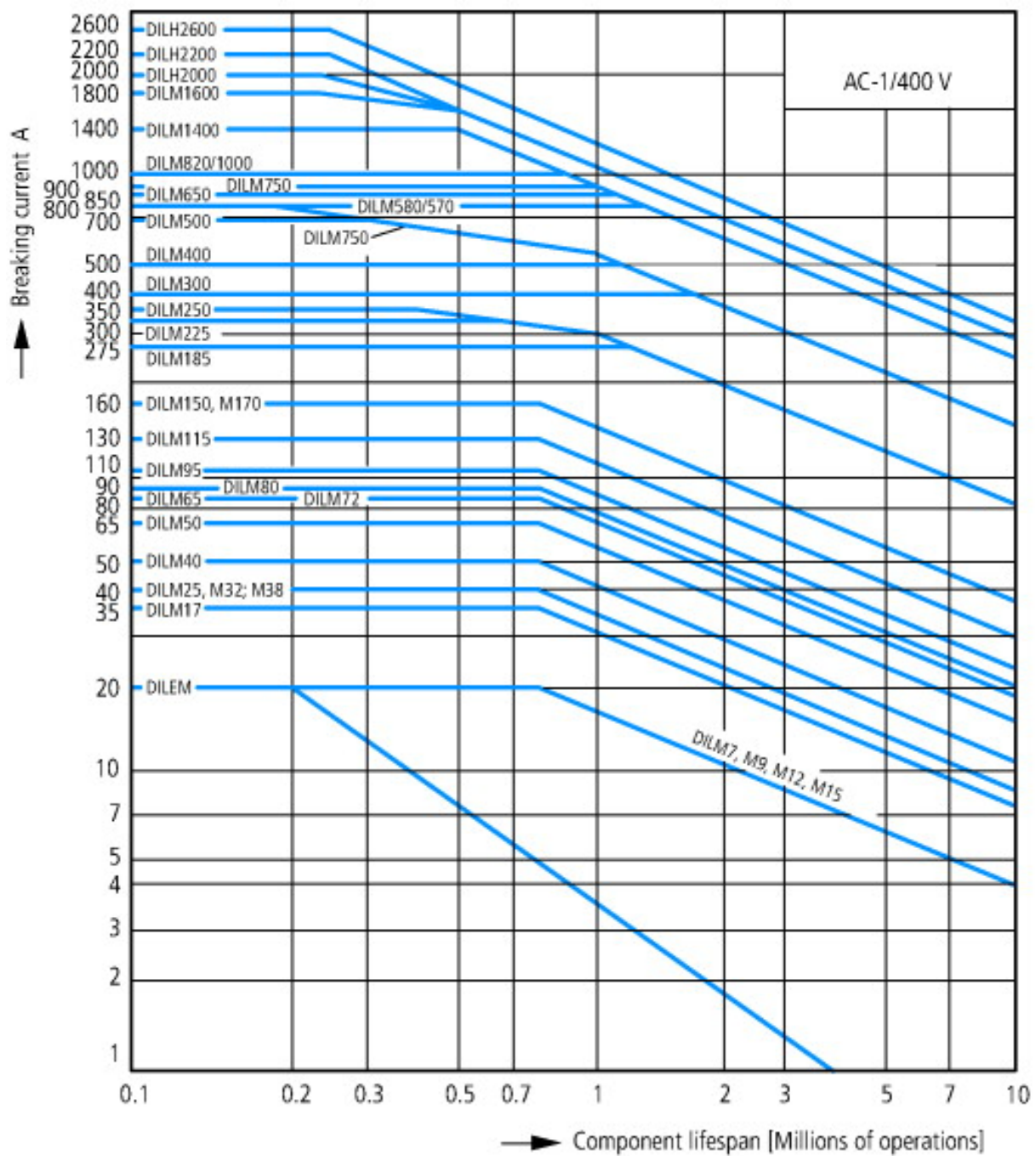

Switching duty for non-motor loads, 3-pole, 4-pole  
 Operating characteristics  
 Non-inductive or slightly inductive loads  
 Electrical characteristics  
 Make: 1 x rated current  
 Break: 1 x rated current  
 Utilization category  
 100 % AC-1  
 Typical applications  
 Electric heat

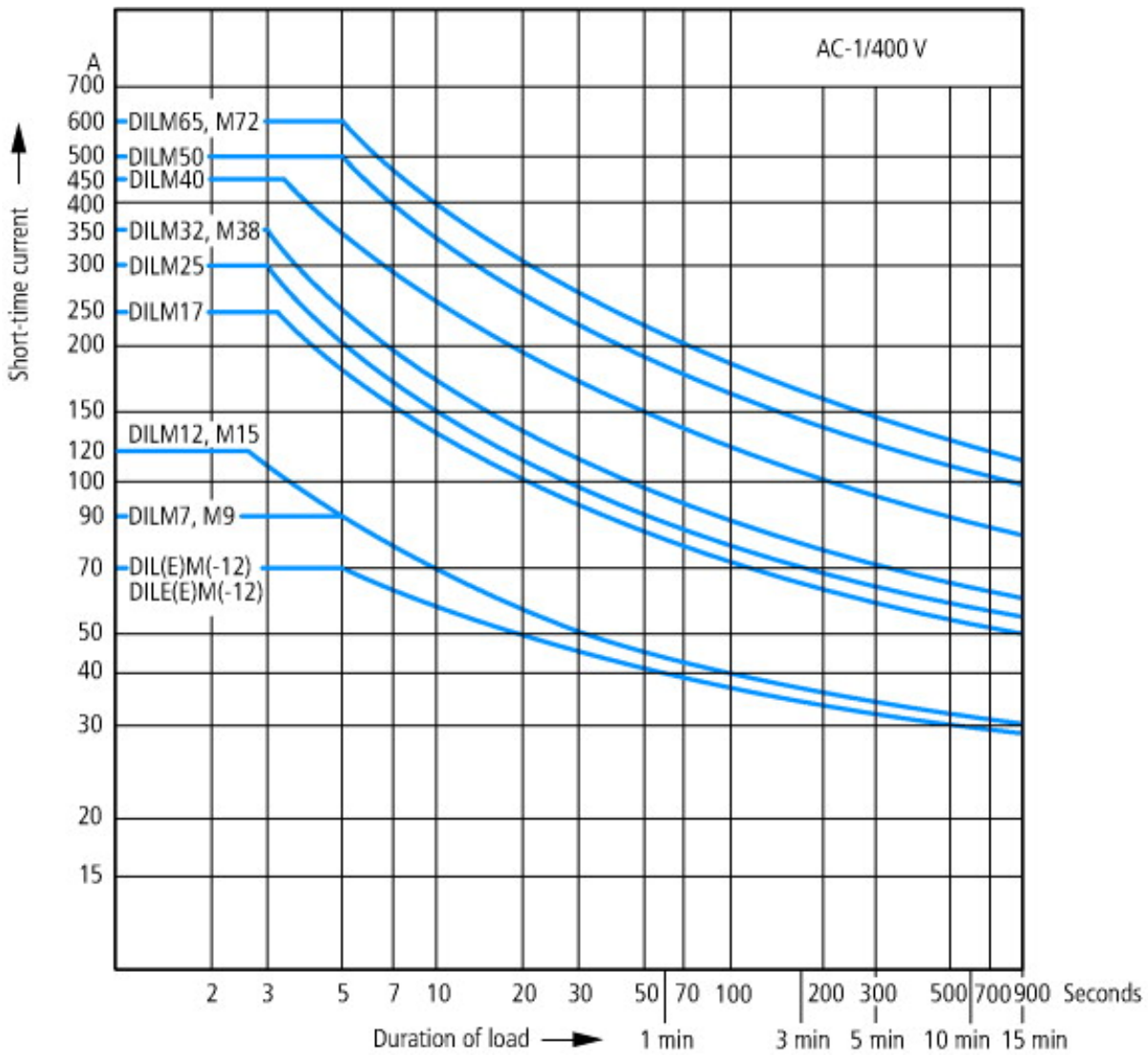

Short-time loading, 3-pole  
Time interval between two loading cycles: 15 minutes

### Dimensions

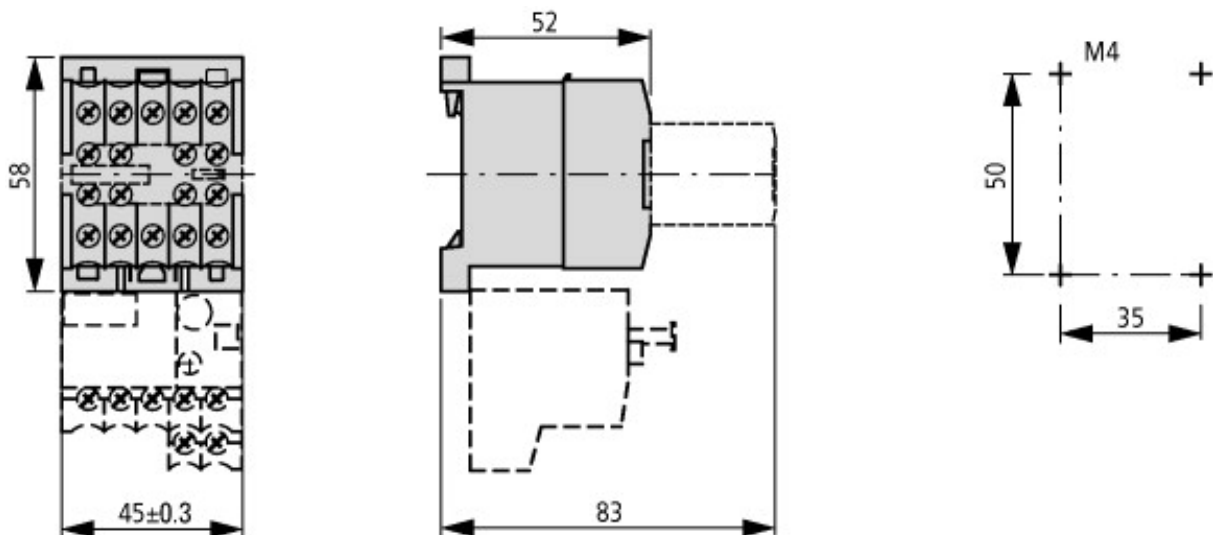

### Additional product information (links)

**IL03407009Z (AWA2100-0882) Mini contactor relay**

IL03407009Z (AWA2100-0882) Mini contactor relay

[ftp://ftp.moeller.net/DOCUMENTATION/AWA\\_INSTRUCTIONS/IL03407009Z2010\\_10.pdf](ftp://ftp.moeller.net/DOCUMENTATION/AWA_INSTRUCTIONS/IL03407009Z2010_10.pdf)

<http://de.ecat.moeller.net/flip-cat/?edition=HPLTE&startpage=5.84>